

## Floodlights Projektörler

### Cruzo



Designed for sport and wide areas lighting  
10kV internal surge protection  
IP67 Dust and Waterproof Driver  
62.000 hours driver lifetime  
30° / 60° / 90° / Asymmetric Lens

Spor sahaları ve geniş alan aydınlatması için tasarlandı  
10kV dahili parafudr  
IP67 Toz ve Su Almaz Driver  
62.000 saat driver ömrü  
30° / 60° / 90° / Asymmetric Lens



#### Mekanik Özellikler

Body	Gövde	Aluminium Alüminyum
IP Rating	IP Sınıfı	IP66
IK Rating	IK Gövde Sınıfı	IK09
Fire Protection	Alev Koruması	650°C
Cable Gland	Kablo Rakor	Metal
Cable	Kablo	3x1,5mm <sup>2</sup>
RAL Code	Ral Kodu	7043
Mounting Type	Montaj Tipi	Pole/Ground Direk / Zemin



#### Optik Özellikler

Light Source	Işık Kaynağı	Power LED
Reflector	Reflektör	-
Lens	Lens	PMMA
Diffuser	Difüzör	Tempered Glass Temperli Cam
CRI		>70
Colour Temperature	Renk Sıcaklığı	4000K - 5700K - 6500K
Photobiological Risk Group	Fotobiyolojik Risk Grubu	RG1
Beam Angle	Işık Açısı	30° / 60° / 90° / Asymmetric



#### Elektriksel Özellikler

Input Voltage	Giriş Gerilimi	220-240Vac
Frequency	Frekans	50-60Hz
Class	Sınıf	I
System Lifetime	Sistem Ömrü	>62.000h
Power Factor	Güç Faktörü	>0,95
Operating Temperature	Çalışma Sıcaklığı	-25°C / 50°C
Standards	Standartlar	60598-2-5, LM79, EN 13032, LM80, EN 62262, EN 60529



#### Opsiyonlar

DALI		✓
1-10V		✓
Step DIM		✓
1hour Emergency Kit	1 Saat Acil Kit	-
3hour Emergency Kit	3 Saat Acil Kit	-
Electrical Protection	Elektriksel Sınıf	I/II
Microwave Sensor	Radar Sensör	-

**CB ENEC CE**

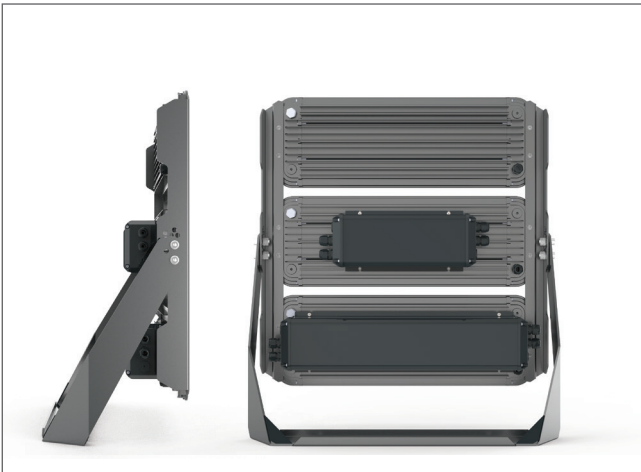



## Technical Drawing

### Teknik Çizim

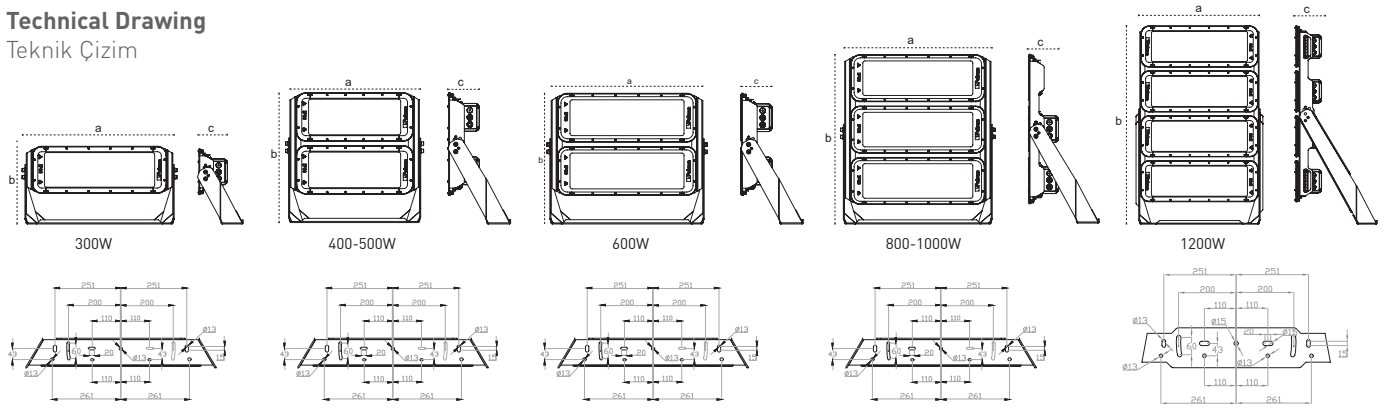

## Light Distribution Curve

### Işık Şiddeti Dağılım Eğrisi

#### 30° Lens

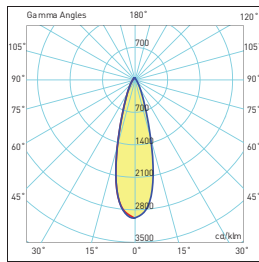

#### 60° Lens

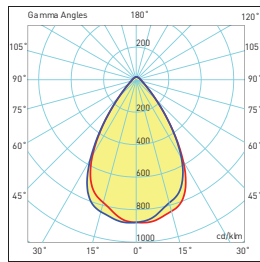

#### 90° Lens

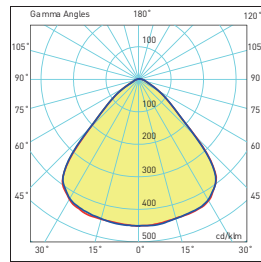

#### Asymmetric / Asimetrik

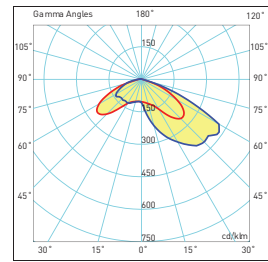

180.00 — 0.0 270.0 — 90.0  $\eta$ : 1000 0 %

Code No Ürün Kodu	Power Güç (W)	Luminous Flux Işık Akısı (lm)	Colour Temp. Renk Sıcaklığı (K)	Efficacy Etkinlik Faktörü (lm/W)	Dimensions Boyutlar (mm) a x b x c	Pcs / Pack Koli Adedi		Package Vol. Koli Hacmi (m³)	Package Weight Koli Ağırlığı (kg)
110791	300	42300	5700	141	755x378x223	1	0,165m²	0,09	15
110792	400	58000	5700	145	655x615x290	1	0,293m²	0,11	25
110793	500	71000	5700	142	655x615x290	1	0,293m²	0,11	25
110794	600	84600	5700	141	755x615x290	1	0,341m²	0,13	32
110795	800	115200	5700	144	755x825x355	1	0,519m²	0,17	45
110796	900	126900	5700	141	755x825x355	1	0,519m²	0,17	45
110797	1000	139000	5700	139	755x825x355	1	0,519m²	0,17	45
110798	1200	157000	5700	130	755x1104x456	1	0,697m²	0,23	67

Products codes refer to 5700K and standard products. So, it can be different for options.

Product technical values can be changed  $\pm 7\%$  at different working conditions.

Ürün kodları 5700K standart ürün içindir, farklı CCT ve opsiyonlar için değişebilir.

Ürün bilgileri farklı çalışma koşullarında  $\pm 7\%$  değişiklik gösterebilir.

Visit our website for latest product informations and documents.

Güncel ürün bilgi ve belgeleri için web sitemizi ziyaret ediniz.

