

## Park and Garden Luminaires Park Bahçe Direk Armatürleri Palmira

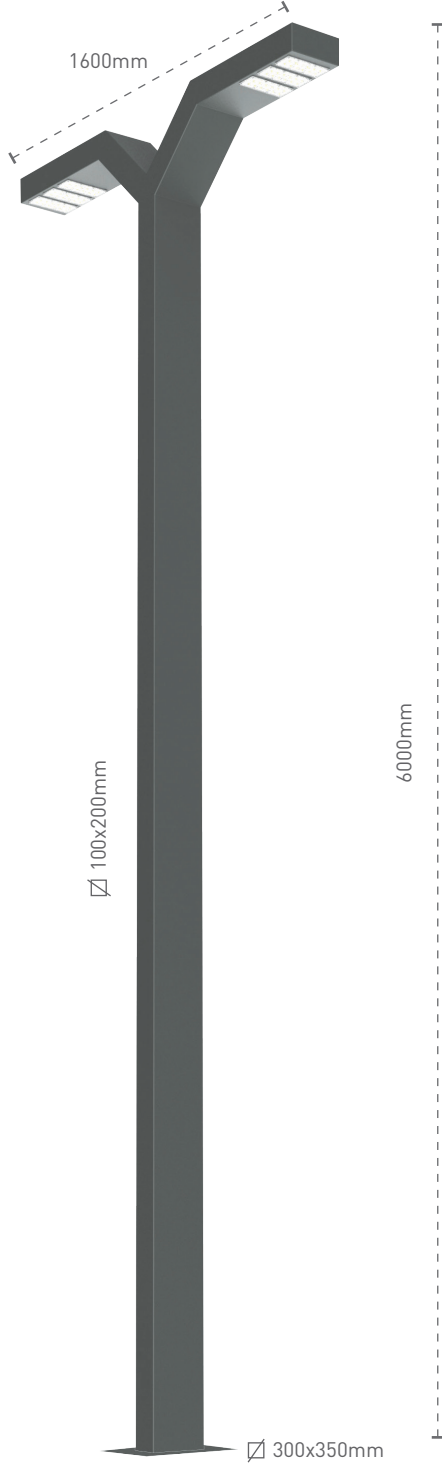

### Mechanical Specifications Mekanik Özellikler

Body Gövde	Aluminium Alüminyum
Pole Direk	Metal
IP Rating IP Sınıfı	IP65
IK Rating Body IK Gövde Sınıfı	IK08
Fire Protection Alev Koruması	650°C
Cable Gland Kablo Rakor	-
Cable Kablo	3x1.5mm <sup>2</sup>
RAL Code Ral Kodu	9005-9006-7043
Mounting Type Montaj Tipi	Ground Zemin

### Optical Specifications Optik Özellikler

Light Source Işık Kaynağı	Power LED
Reflector Reflektör	-
Lens Lens	PMMA
Diffuser Difüzör	-
CRI	>70
Colour Temperature Renk Sıcaklığı	3000K / 4000K / 6500K
Photobiological Risk Group Fotobiyolojik Risk Grubu	RG0
Beam Angle Işık Açısı	Asymmetric Asimetrik

### Electrical Specifications Elektriksel Özellikler

Input Voltage Giriş Gerilimi	220-240Vac
Frequency Frekans	50-60Hz
Class Sınıf	I
System Lifetime Sistem Ömrü	>50.000h
Power Factor Güç Faktörü	>0,95
Operating Temperature Çalışma Sıcaklığı	-20°C / +45°C
Standards Standartlar	60598-2-2, LM80, EN 62262, EN 60529

### Options Opsiyonlar

DALI	✓
1-10V	-
Step DIM	✓
1hour Emergency Kit 1 Saat Acil Kit	-
3hour Emergency Kit 3 Saat Acil Kit	-
Electrical Protection Elektriksel Sınıf	I
Microwave Sensor Radar Sensör	-
RAL Code RAL Kodu	✓
Marine Paintingr Marin Boya	✓

Code No Ürün Kodu	Power Güç (W)	Luminous Flux Işık Akısı (lm)	Colour Temp. Renk Sıcaklığı (K)	Efficacy Etkinlik Faktörü (lm/W)	Dimensions Boyutlar (mm) axbxc	Pcs / Pack Koli Adedi	Package Weight Koli Ağırlığı (kg)
109735	75	8775	4000	117	4500x300x350	1	38
109733	75	8775	4000	117	6000x300x350	1	50
109734	125	14625	4000	117	6000x300x350	1	55
109408	150	17550	4000	117	6000x300x350	1	55

Product codes can change by the kelvins, dimensions, or options. Please get in contact with the sales team.

Technical values has tolerance +-%7 by the operating conditions.

Ürün kodları kelvin, boyut ve opsiyonlar için değişebilir. Lütfen satış ekibi ile iletişime geçiniz.

Teknik sonuçlar çalışma koşullarına bağlı olarak +-%7 toleransa sahiptir.

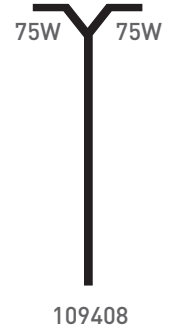
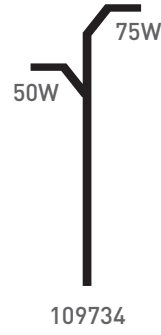
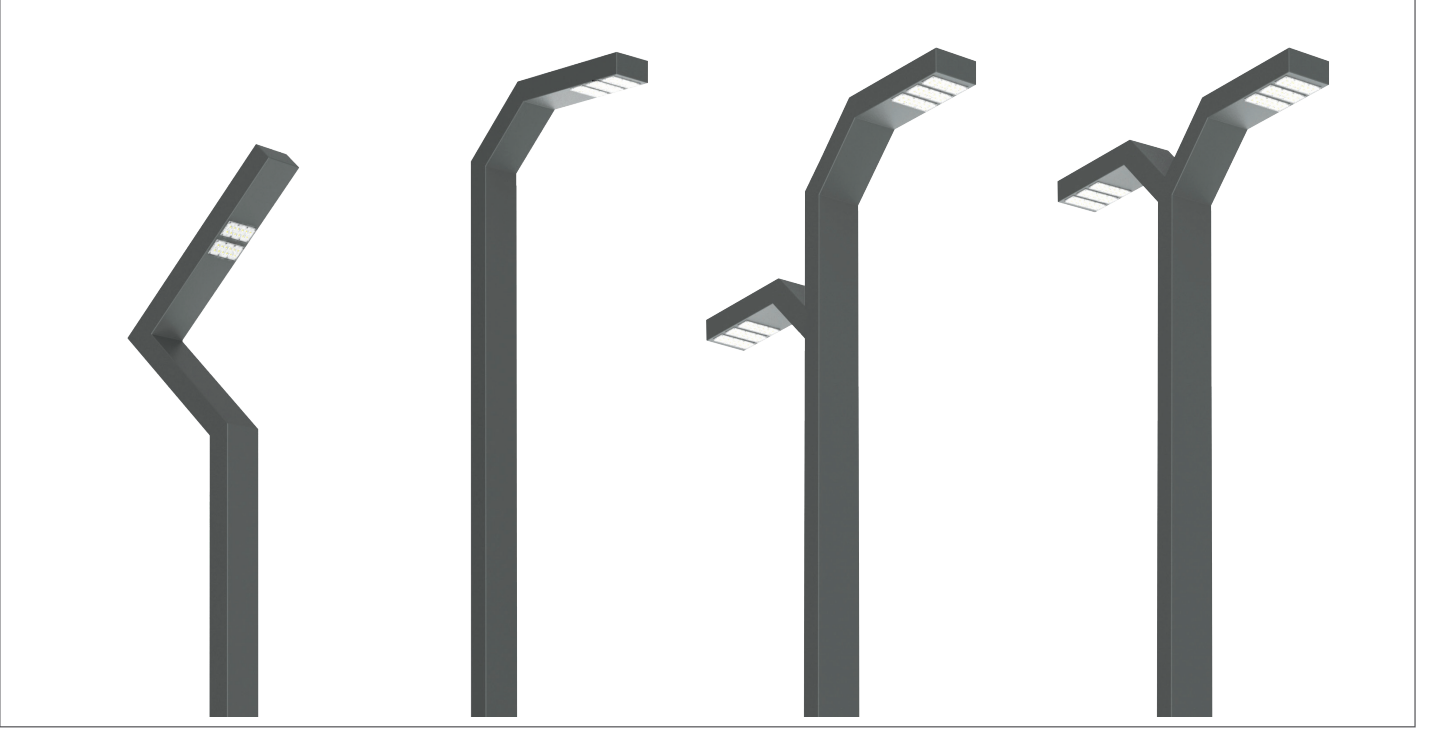

### Technical Drawing

Teknik Çizim

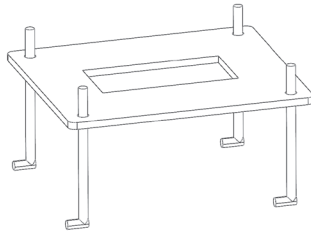
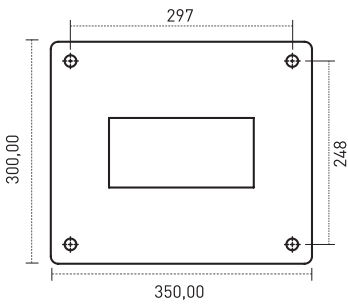

### Light Distribution Curve

Işık Şiddeti Dağılım Eğrisi

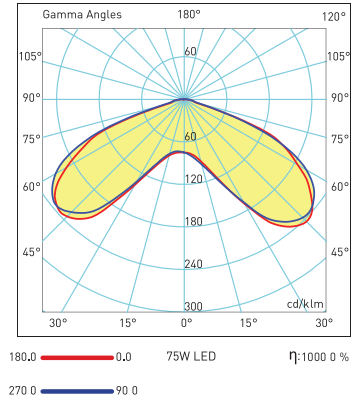

Visit our website for latest product informations and documents.  
Güncel ürün bilgi ve belgeleri için web sitemizi ziyaret ediniz.

