

 **Pelsan**

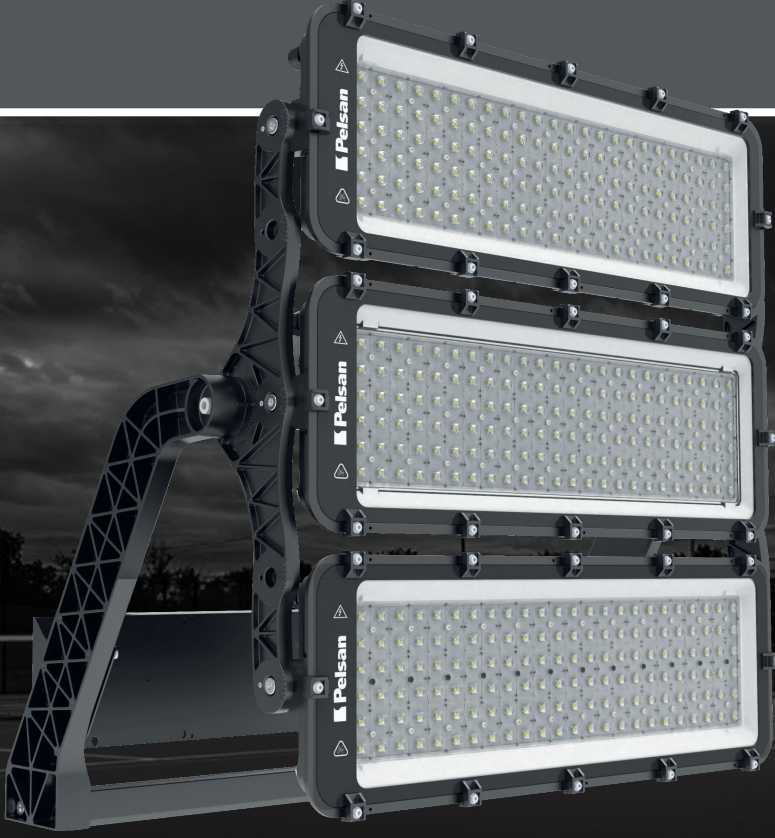

**YÜKSEK GÜÇLÜ
PROFESYONEL
PROJEKTÖR**

CRUZO G2

www.pelsan.com.tr

 **Pelsan**

YÜKSEK GÜÇLÜ PROFESYONEL
PROJEKTÖR

CRUZO G2

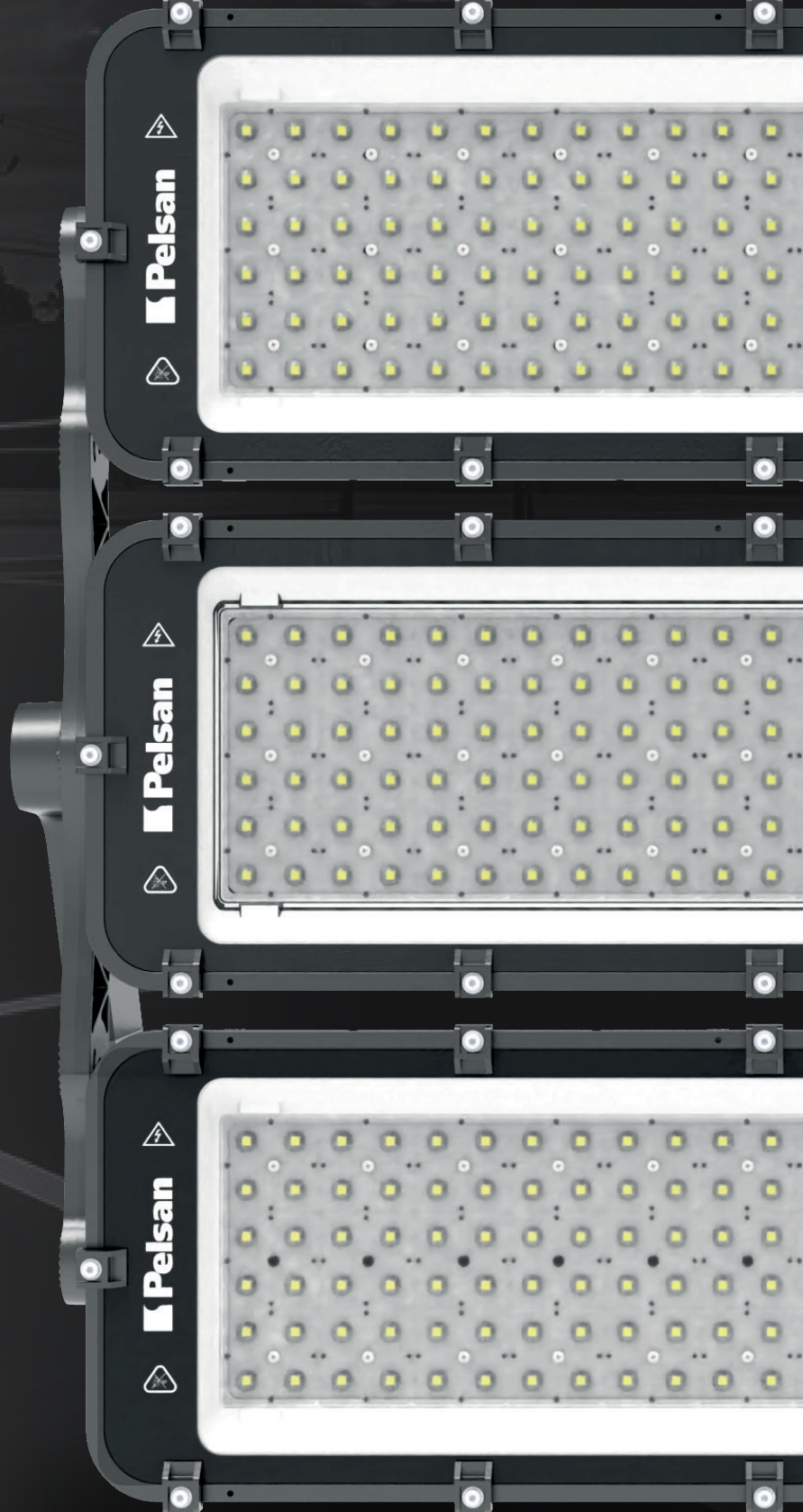

Geniş alanlar ve spor sahaları için yüksek güçlü profesyonel projektör **CRUZO G2**

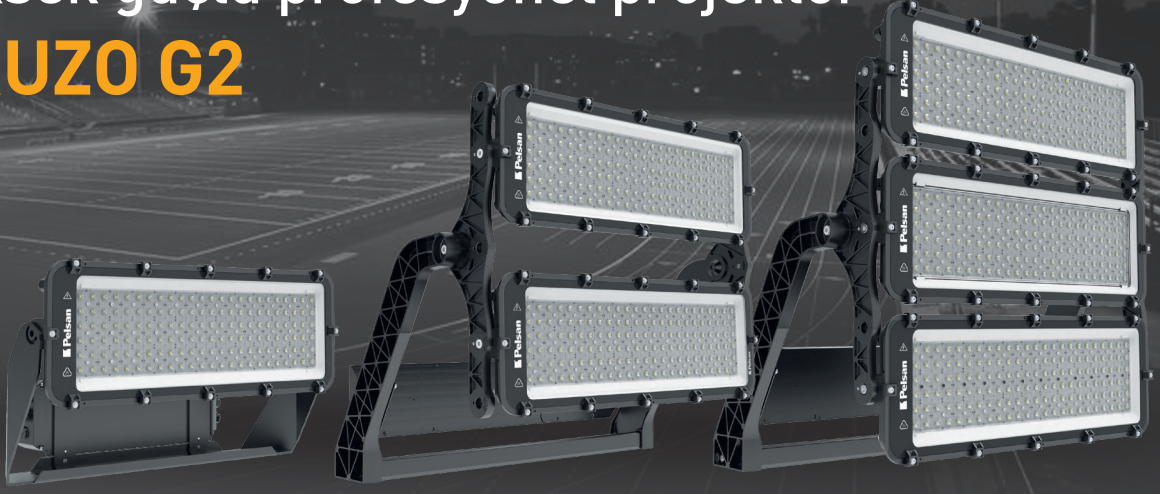

G2 versiyonu ile yenilenen Cruzo, artık 1800W'a kadar geniş güç seçeneği ve 250.200'a varan geniş lümen paketleri ile stadyumlar, meydanlar ve büyük alanlar için profesyonel bir çözümdür.

Esnek

Cruzo G2, farklı koşullara ve farklı direk yüksekliklerine uygundur. Bir ailede birçok özellik sunar ve otomasyon seçenekleri ile geliştirilebilir.

- 1 Modül (300-600W) / 2 Modül (800-1200W) / 3 Modül (1000-1800W)
- 10°/17°/30°/60°/90°/Asimetrik lens seçenekleri
- Marin boya ile kıyı bölgelerinde yüksek koruma
- Geniş otomasyon seçenekleri (DMX RDM, DALI, 1-10V, Step DIM)
- CRI90, Flicker Free
- Sınıf I/II seçeneği

Geniş Optik Tasarım

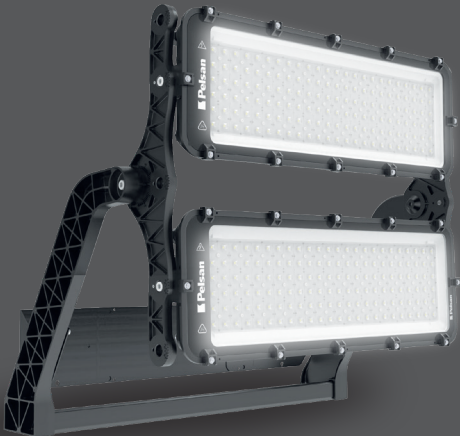

Cruzo G2, farklı uygulama alanları için 42 optik seçeneği ile kesin bir çözüm sunar.

- Açı ayarlanabilir alüminyum enjeksiyon braketler
- Her bir modül $\pm 30^\circ$ açı ayarlanabilir
- Asimetrik, 10° ila 90° arasında geniş lens seçeneği
- Standart 7 farklı lümen paketi, özelleştirilebilir ışık çıkışı

Geniş Lümen Paketleri

Cruzo G2, yüksek verimli LED çipleri ile 47100 ile 250200 arasında geniş lümen paketleri sunar.

1 modül : 47100lm - 83400lm
2 modül : 128000lm - 175200lm
3 modül : 222000lm - 250200lm



1 modül

2 modül

3 modül



Termal Isı Direnci

Aydınlatma armatürlerinin kullanımı sırasında, zamanla sürücü ve pcb alanında ısınma meydana gelir. Bileşenlerin ısı dağılımı etkin bir şekilde tasarlanmazsa, armatürde deformasyonlara neden olabilir.

Cruzo G2, yeni tasarımıyla termal ısı direncini maksimum seviyeye çıkarır. Yekpare, federli alüminyum enjeksiyon gövde yapısı ve LED modülü ile sürücünün ayrı konumlandırılması sayesinde maksimum ısı dağılımı sağlar.

Uzun Ömürlüdür

Yüksek güçlü projektörler, aşırı ve ani sıcaklık değişimleri, ani voltaj dalgalanmaları, yıldırım düşmesi ve rüzgar gibi zorlu çevresel koşullarda çalışır.

Cruzo G2, üstün ve benzersiz elektriksel, mekanik ve termal tasarımıyla uzun süreli yüksek performans sunar.

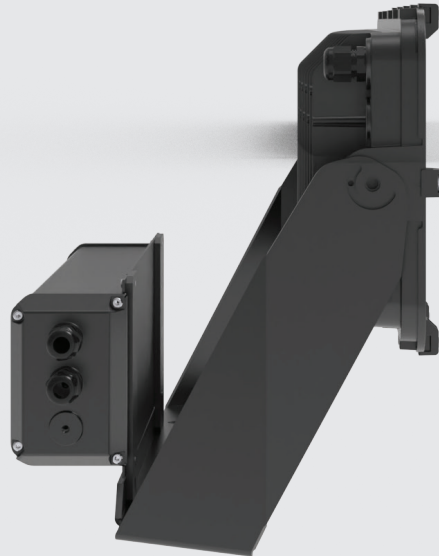

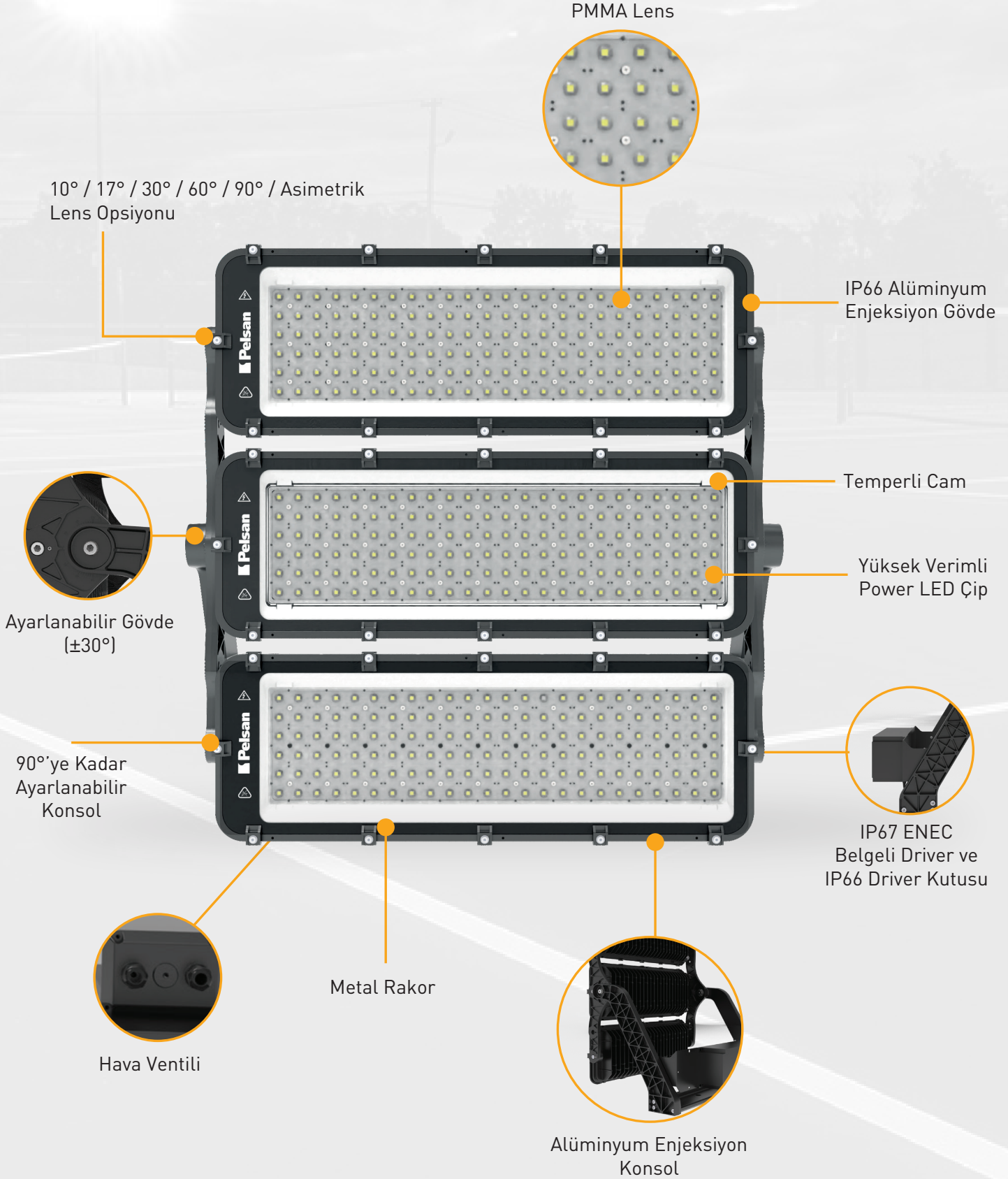

HD Boardcast



Flicker Free



CRI90



DALI, DMX RDM

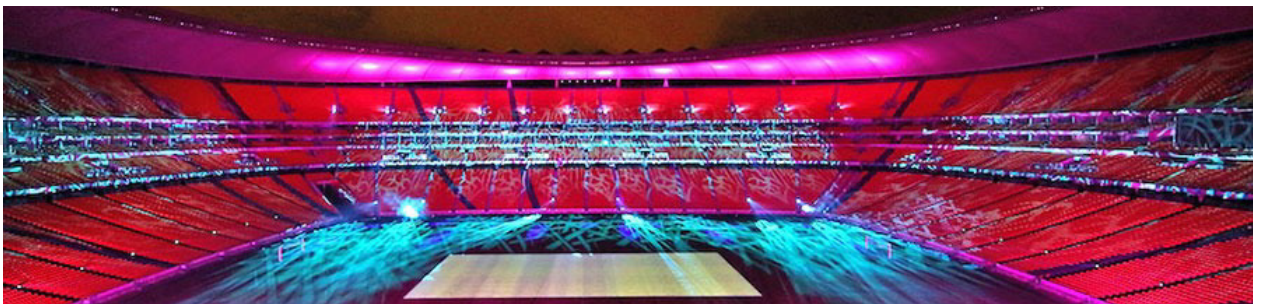

Opsiyonlar

Geniş Optik Seçenekler

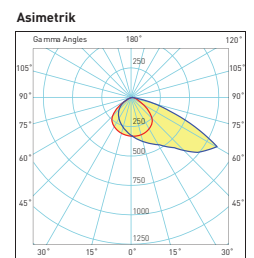
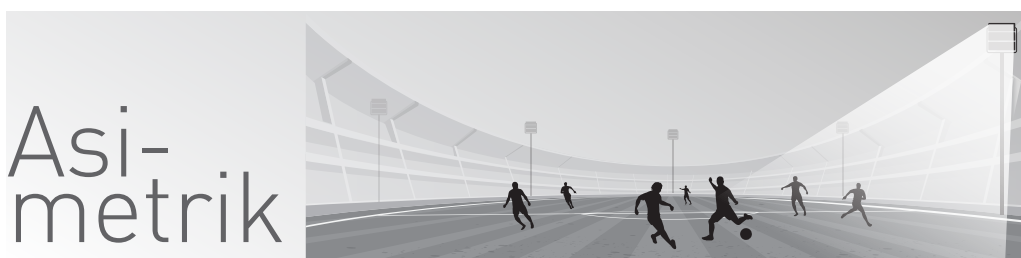
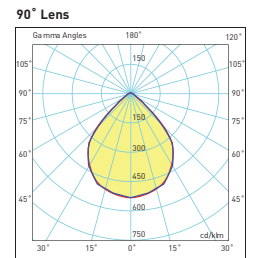
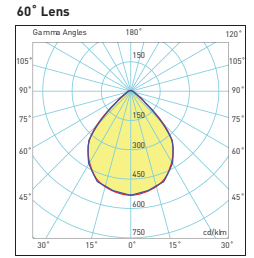
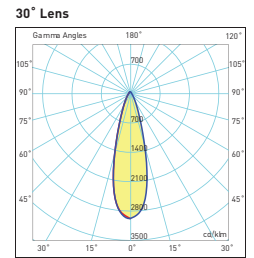
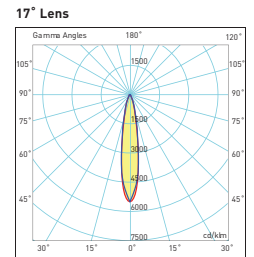
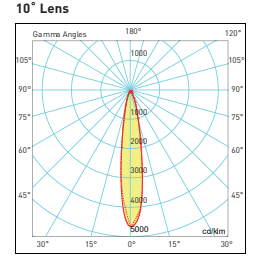



Mekanik Özellikler

Gövde	Alüminyum
IP Sınıfı	IP66
IK Sınıfı	IK09
Ağırlık (kg)	18 - 29 - 38kg
RAL Kodu	7043
Boyutlar (mm)	716x387x319 / 816x723x479 / 816x821x479



Elektriksel Özellikler

Güç	500-1000-1500-1800W
Işık Akısı	70.000 - 150.000 - 222.000- 250.200lm
Etkinlik Faktörü	140 - 150 - 148 - 139 lm/W
LED Çip ve Sürücü Markası	Samsung - IP67 ENEC Belgeli Driver
LED Çip Ömrü	Ts=85°C 100.000h
LED Sürücü Ömrü	@Tc<72°C'de 62.000
Giriş Gerilimi	220-240Vac
Frekans	50-60Hz
Güç Faktörü (Tam Güçte)	>0,95
SPD	10kV
THD	%10
Çalışma Sıcaklığı	-40°C / 50°C
Sınıf	I



Optik Özellikler

Işık Akısı	70.000 - 150.000 - 222.000- 250.200lm
Etkinlik Faktörü	140 - 150 - 148 - 139 lm/W
Lens	PMMA
Difüzör	Temperli Cam
CRI	>70
Renk Standardı	Quarter Bin
Renk Sıcaklığı	4000K - 5700K - 6500K



Opsiyonlar





DALI	Uygun
DMX RDM	Uygun
1-10V	Uygun
2 Step Dim	Uygun
Sınıf I / Sınıf II	Uygun
Marin Boya	Uygun
Harici SPD	Uygun

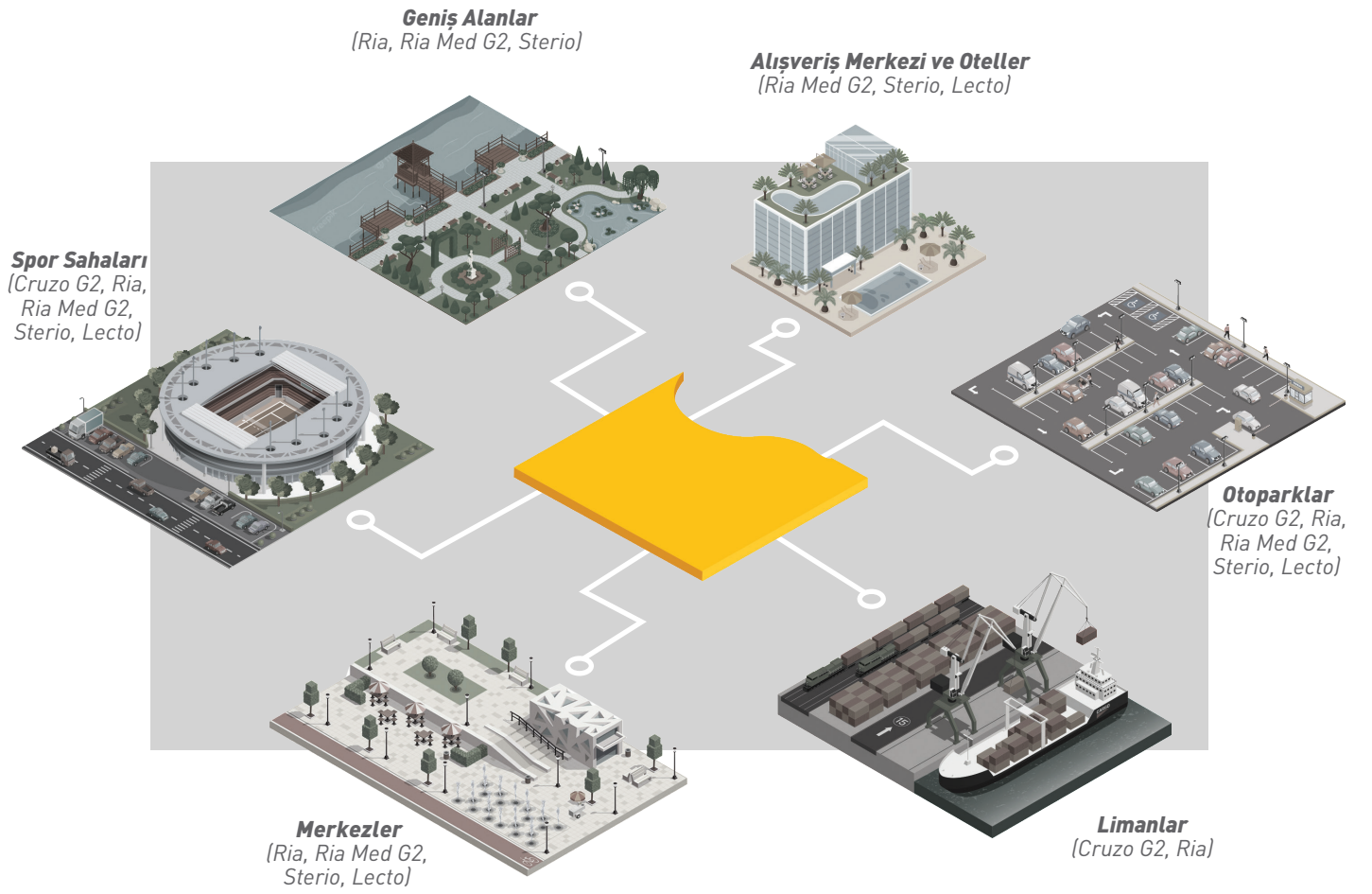

Uygulama Alanları

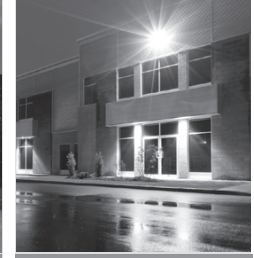

Diğer Projektörler

						
						
Tip		Cruzo G2	Ria Lens	Ria Med G2	Sterio	Lecto
Lümen Paketi		42.300lm 246.600lm	30.800lm 58.000lm	8.820lm 19.050lm	5.000lm 45.000lm	5.000lm 50.000lm
Güç		300W-1800W	200W-400W	60W-150W	50W-450W	50W-500W
Etkinlik Faktörü		Up to 144lm/W	Up to 154lm/W	Up to 147lm/W	+100lm/W	+100lm/W
Ömür		>62,000h	>62,000h	>62,000h	>30,000h	>30,000h
Garanti		2 Year	5 Year	5 Year	2 Year	2 Year
Optik		10°/17°/30°/60°/90° Asymmetric Lens	30°/60°/90° Asymmetric Lens	30°/60°/90° Asymmetric Lens	Symmetric Reflector	Symmetric/ 120° Reflector
OPSİYONLAR	DALI	✓	✓	✓		
	2 Step	✓	✓	✓		
	1-10V	✓	✓	✓		
	Fotosel					
	Elektrik Koruması	I/II	I/II	I/II	I	I
	RAL Kod		✓	✓		
	Marin Boya	✓	✓	✓		

Pelsan



Tüm aydınlatma ihtiyaçlarınız için tek adres.

www.pelsan.com.tr
info@pelsan.com.tr | export@pelsan.com.tr

MERKEZ

Çerkeşli O.S.B.
İmes 5. Cadde No:12
Dilovası / Kocaeli - TÜRKİYE



/PelsanAydınlatma



pelsan-aydinlatma



pelsan aydinlatma



/pelsanaydinlatma



/PelsanLight

T : +9[0850] 460 75 76
F : +9[0216] 364 60 15

 **Pelsan**



**YÜKSEK GÜÇLÜ
PROFESYONEL
PROJEKTÖR**

CRUZO G2

 **Pelsan**

