



FLOODLIGHTS

2024

www.pelsan.com.tr



Since
1982



More than
3500 SKU



500
Employees



5 million luminaire
production capacity per year

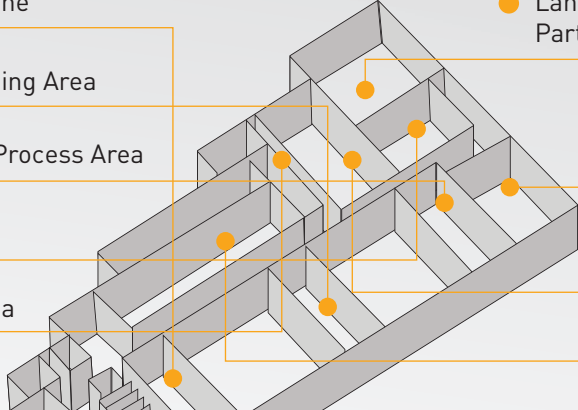

Factory

- 
- Electronic Assembly Line
 - Plastic Injection Moulding Area
 - Semi-Finished Goods Process Area
 - Moulding Area
 - Diffuser Treatment Area
 - Landscape Lighting Fixture Parts Manufacturing Area
 - Glass Reinforced Polyester (GRP) Product Manufacturing Area
 - Powder Coating & Painting Area
 - Assembly Line
 - Office

30000 ^{m²} **Manufacturing Zone**

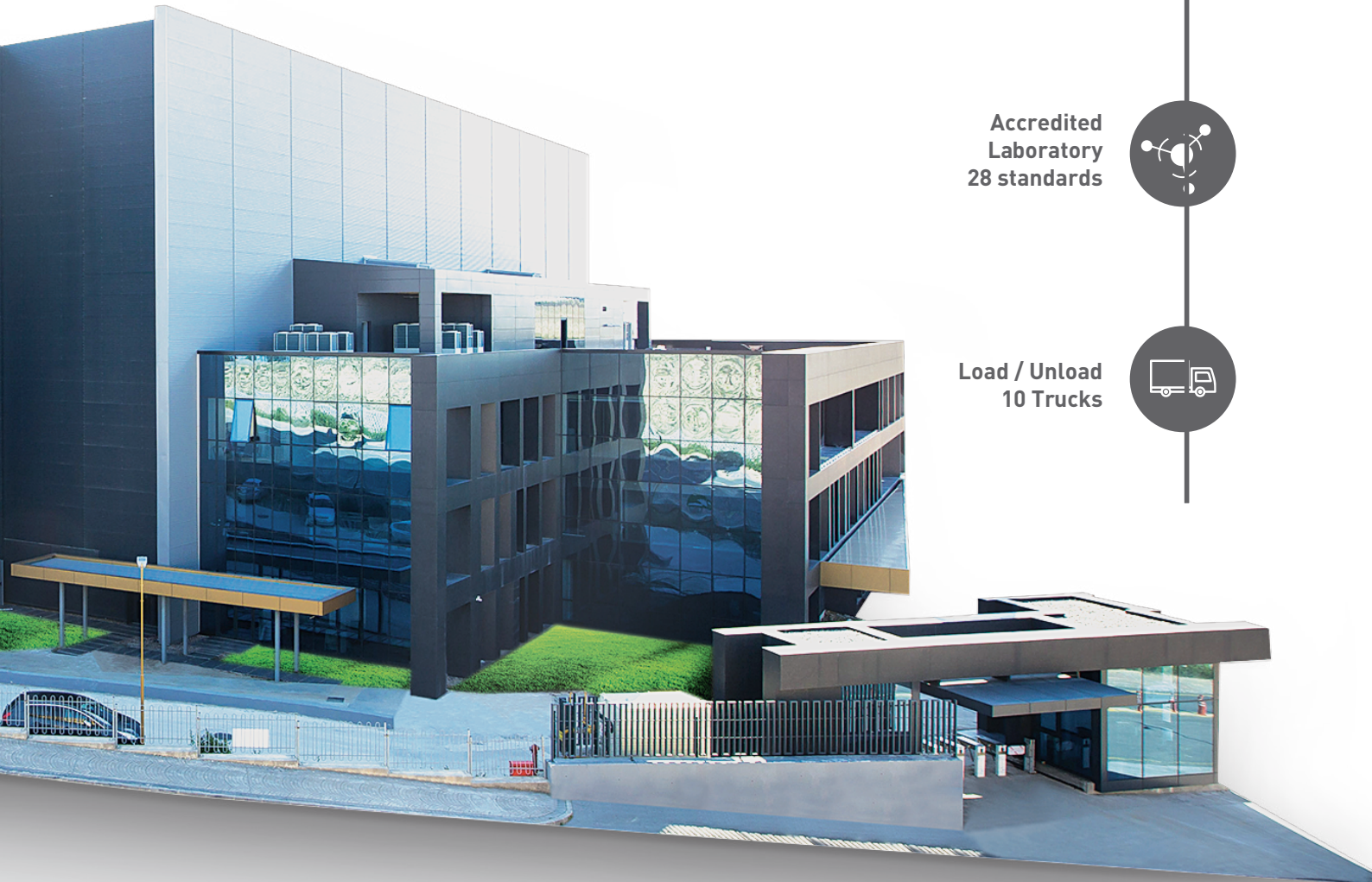

R&D Center
15 Engineers



**Accredited
Laboratory**
28 standards



Load / Unload
10 Trucks



Wide Areas
(Ria, Ria Med G2, Sterio)

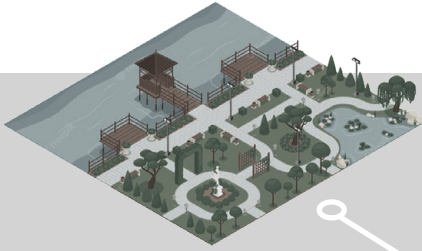

Shopping Mall & Hotels
(Ria Med G2, Sterio, Lecto)



Sports Fields
(Cruzo G2, Ria,
Ria Med G2,
Sterio, Lecto)

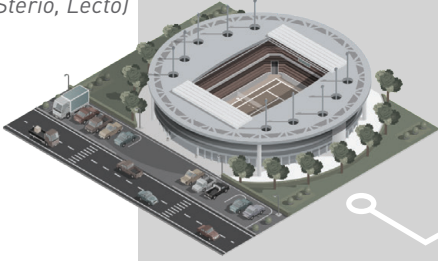

CarPark
(Cruzo G2, Ria,
Ria Med G2,
Sterio, Lecto)

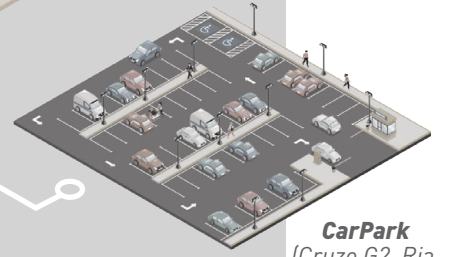

Squares
(Ria, Ria Med G2,
Sterio, Lecto)

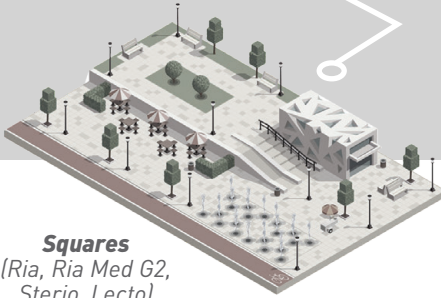

Ports
(Cruzo G2, Ria)

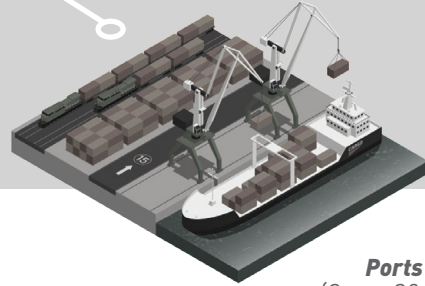



Type	Cruzo G2	Ria Lens	Ria Med G2	Sterio	Lecto	
Lumen Package	42.300lm 246.600lm	28.800lm 40.500lm	8.820lm 26.000lm	5.000lm 45.000lm	3.000lm 50.000lm	
Power	300W-1800W	200W-300W	60W-200W	50W-450W	30W-500W	
Efficacy	Up to 144lm/W	Up to 144lm/W	Up to 147lm/W	+100lm/W	+100lm/W	
Lifetime	>62,000h	>62,000h	>62,000h	>30,000h	>30,000h	
Warranty	2 Year	5 Year	5 Year	2 Year	2 Year	
Optic	10°/30°/60°/90° Asymmetric Lens	30°/60°/90° Asymmetric Lens	30°/60°/90° Asymmetric Lens	Symmetric Reflector	Symmetric/ 120° Reflector	
OPTIONS	DALI	✓	✓	✓		
	2 Step	✓	✓	✓		
	1-10V	✓	✓	✓		
	Photocell					
	Electrical Protection	I/II	I/II	I/II	I	I
	RAL Code		✓	✓		
	Marine Painting	✓	✓	✓		



Floodlights Projektörler

Cruzo G2

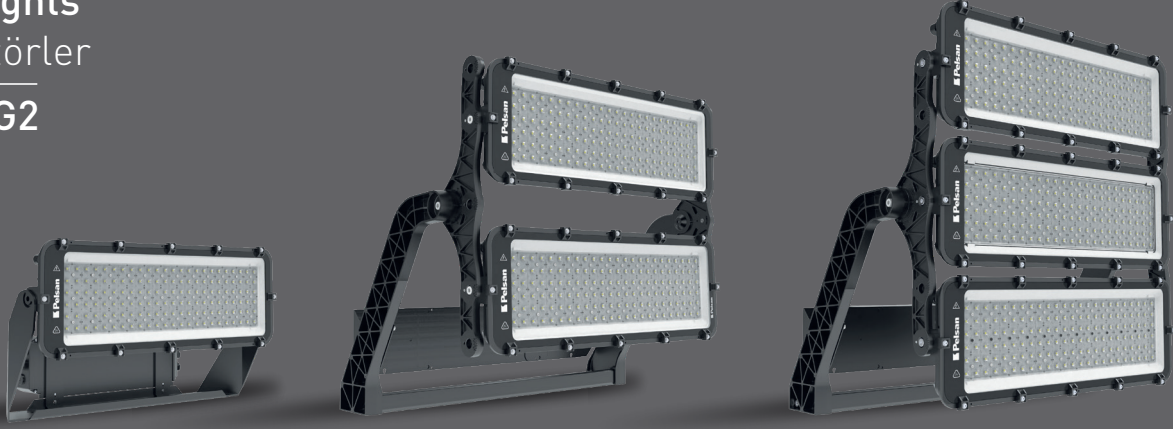

Designed for sport and wide areas lighting
300W-1000W: 10kV,
1200W-1800W: 20kV internal surge protection
IP67 Dust and Waterproof Driver
62.000 hours driver lifetime
10° / 30° / 60° / 90° / Asymmetric Lens

Spor sahaları ve geniş alan aydınlatması için tasarlandı
300W-1000W: 10kV,
1200W-1800W: 20kV dahili parafudr
IP67 Toz ve Su Almaz Driver
62.000 saat driver ömrü
10° / 30° / 60° / 90° / Asimetrik Lens

*  CB ENEC CE



* It is valid up to 1200W 1200W'a kadar geçerlidir.

Mechanical Specifications Mekanik Özellikler

Body	Gövde	Aluminium	Aluminyum
IP Rating	IP Sınıfı	IP66	
IK Rating	IK Gövde Sınıfı	IK09	
Fire Protection	Alev Koruması	650°C	
Cable Gland	Kablo Rakor	Metal	
Cable	Kablo	3x1,5mm ²	
RAL Code	Ral Kodu	7043	
Mounting Type	Montaj Tipi	Pole/Ground	
		Direk / Zemin	

Optical Specifications Optik Özellikler

Light Source	Işık Kaynağı	Power LED	
Reflector	Reflektör	-	
Lens	Lens	PMMA	
Diffuser	Difüzör	Tempered Glass	Temperli Cam
CRI		>70	
Colour Temperature	Renk Sıcaklığı	4000K - 5700K - 6500K	
Photobiological Risk Group	Fotobiyolojik Risk Grubu	RG1	
Beam Angle	Işık Açısı	10°/30°/60°/90°/Asymmetric	

Electrical Specifications Elektriksel Özellikler

Input Voltage	Giris Gerilimi	220-240Vac
Frequency	Frekans	50-60Hz
Class	Sınıf	I
System Lifetime	Sistem Ömrü	>62.000h
Power Factor	Güç Faktörü	>0,95
Operating Temperature	Çalışma Sıcaklığı	-40°C / 50°C
Standards	Standartlar	60598-2-5, LM79, EN 13032, LM80, EN 62262, EN 60529

Options Opsiyonlar

DALI		✓
1-10V		✓
Step DIM		✓
1hour Emergency Kit	1 Saat Acil Kit	-
3hour Emergency Kit	3 Saat Acil Kit	-
Electrical Protection	Elektriksel Sınıf	I/II
Microwave Sensor	Radar Sensör	-

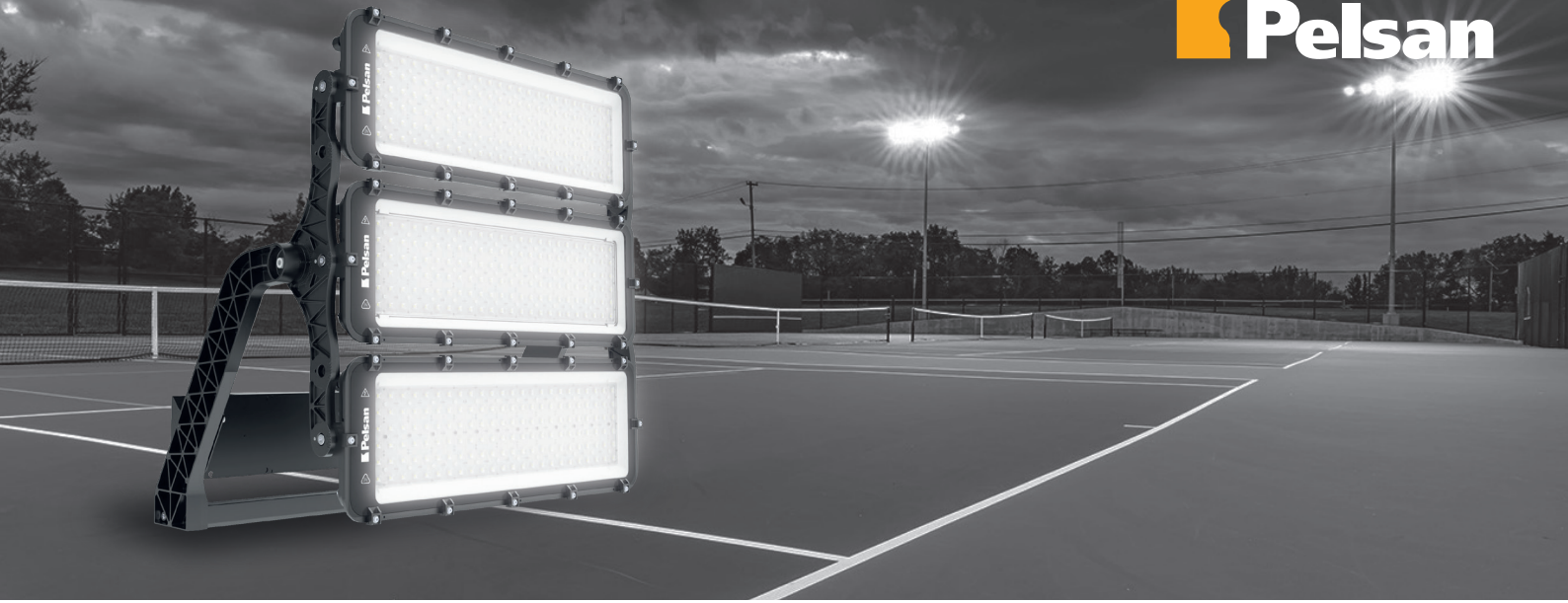

Technical Drawing

Teknik Çizim

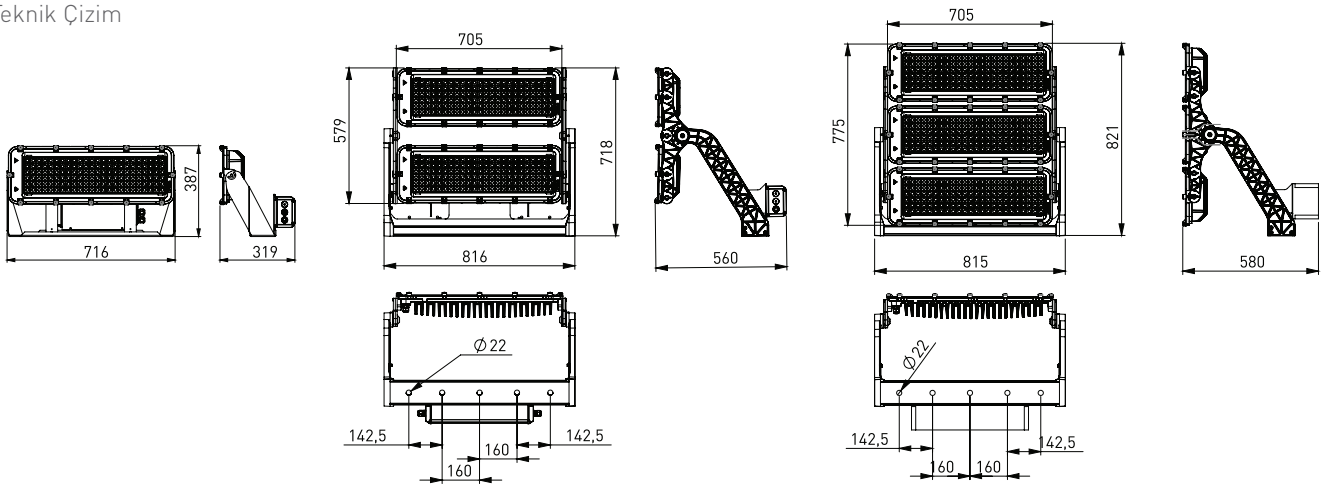

Light Distribution Curve

Işık Şiddeti Dağılım Eğrisi

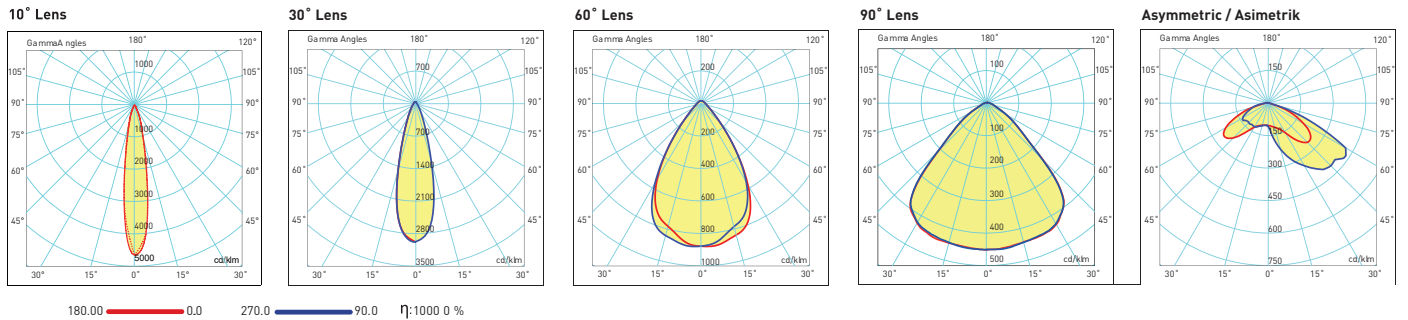

Code No Ürün Kodu	Power Güç (W)	Luminous Flux Işık Akısı (lm)	Colour Temp. Renk Sıcaklığı (K)	Efficacy Etkinlik Faktörü (lm/W)	Dimensions Boyutlar (mm) axbxc	Pcs / Pack Koli Adedi	Package Vol. Koli Hacmi (m ³)	Product Weight Ürün Ağırlığı (kg)	Control Box Weight Kontrol Ünitesi Ağırlığı (kg)
116434	300	47100	5700	157	716x387x319	1	0,28	18	5,24
116433	400	61200	5700	153	716x387x319	1	0,28	18	5,24
116438	500	70000	5700	140	716x387x319	1	0,28	18	5,24
116432	600	83400	5700	139	716x387x319	1	0,28	18	5,24
116431	800	128000	5700	160	816x723x479	1	0,28	29	7,4
116430	900	140400	5700	156	816x723x479	1	0,36	29	7,4
116437	1000	150000	5700	150	816x723x479	1	0,36	29	7,4
116429	1200	175200	5700	146	816x723x479	1	0,36	29	7,4
116436	1500	222000	5700	148	816x821x479	1	0,36	38	8,5
116435	1800	250200	5700	139	816x821x479	1	0,36	38	8,5

Products codes refer 5700K and standard products. So, it can be different for options.
Product technical values can be changed $\pm 7\%$ at different working conditions.
Ürün kodları 5700K standart ürün içindir, farklı CCT ve opsiyonlar için değişebilir.
Ürün bilgileri farklı çalışma koşullarında $\pm 7\%$ değişiklik gösterebilir.

Visit our website for latest product informations and documents.
Güncel ürün bilgi ve belgeleri için web sitemizi ziyaret ediniz.



Floodlights Projektörler Ria Lens



5 years warranty

IP66, dust and waterproof aluminium body

IP67 ENEC certified driver

100.000h driver lifetime

10kV internal surge protection

30° / 60° / 90° / Asymmetric lens

5 yıl garanti

IP66, toz ve su almaz alüminyum gövde

IP67 ENEC belgeli driver

100.000h driver ömrü

10kV dahili parafudr

30° / 60° / 90° / Asimetrik lens



Mechanical Specifications

Mekanik Özellikler

Body	Gövde	Aluminium	Alüminyum
IP Rating	IP Sınıfı	IP66	
IK Rating	IK Gövde Sınıfı	IK10	
Fire Protection	Alev Koruması	650°	
Cable Gland	Kablo Rakor	PG13,5	
Cable	Kablo	3x1,5mm ²	
RAL Code	Ral Kodu	9005	
Mounting Type	Montaj Tipi	Pole / Ground	Direk / Zemin

Optical Specifications

Optik Özellikler

Light Source	Işık Kaynağı	Power LED	
Reflector	Reflektör	-	
Lens	Lens	PMMA	
Diffuser	Difüzör	Tempered Glass	Temperli Cam
CRI		>80	
Colour Temperature	Renk Sıcaklığı	3000K / 4000K / 6500K	
Photobiological Risk Group	Fotobiyolojik Risk Grubu	RG01	
Beam Angle	Işık Açısı	30° / 60° / 90°	
		Asymmetric / Asimetrik	

Electrical Specifications

Elektriksel Özellikler

Input Voltage	Giriş Gerilimi	220-240Vac
Frequency	Frekans	50-60Hz
Class	Sınıf	I
System Lifetime	Sistem Ömrü	>62.000h
Power Factor	Güç Faktörü	>0,95
Operating Temperature	Çalışma Sıcaklığı	-20°C / 45°C
Standards	Standartlar	60598-2-5, LM79, EN 13032, LM80, EN 62262, EN 60529

Options

Opsiyonlar

DALI		✓
1-10V		✓
Step DIM		✓
1hour Emergency Kit	1 Saat Acil Kit	-
3hour Emergency Kit	3 Saat Acil Kit	-
Electrical Protection	Elektriksel Sınıf	I/II
Microwave Sensor	Radar Sensör	-
RAL Code	RAL Kodu	✓
Marine Painting	Marin Boya	✓

Code No Ürün Kodu	Power Güç (W)	Luminous Flux Işık Akısı (lm)	Colour Temp. Renk Sıcaklığı (K)	Efficacy Etkinlik Faktörü (lm/W)	Dimensions Boyutlar (mm) axbxc	Pcs / Pack Koli Adedi	Package Vol. Koli Hacmi (m ³)	Package Weight Koli Ağırlığı (kg)
110356	200	30800	6500	154	400x418x100	1	0,018	6
110355	250	36500	6500	146	400x418x100	1	0,018	6
110354	300	42300	6500	141	400x418x100	1	0,018	6
115921	400	58000	6500	145	400x418x100	1	0,018	6

Product codes can change by the kelvins, dimensions, or options. Please get in contact with the sales team.

Technical values has tolerance +/-%7 by the operating conditions.

Ürün kodları kelvin, boyut ve opsiyonlar için değişebilir. Lütfen satış ekibi ile iletişime geçiniz.

Teknik sonuçlar çalışma koşullarına bağlı olarak +/-%7 toleransa sahiptir.

All your lighting needs in one address.
Tüm aydınlatma ihtiyaçlarınız için tek adres.



Technical Drawing

Teknik Çizim

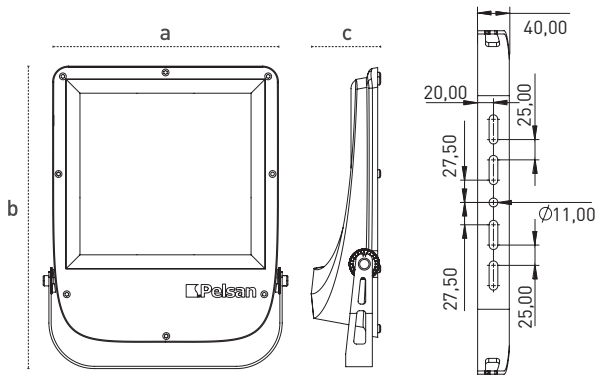

Light Distribution Curve

Işık Şiddeti Dağılım Eğrisi

30° Lens

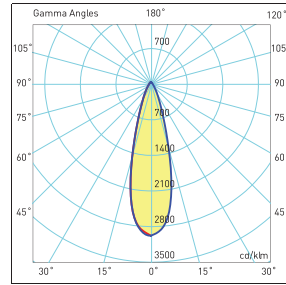

200W / 250W / 300W / 400W

60° Lens

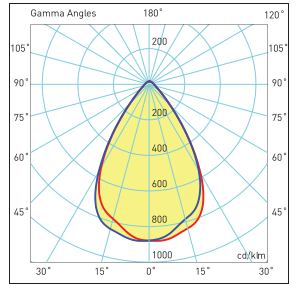

200W / 250W / 300W / 400W

90° Lens

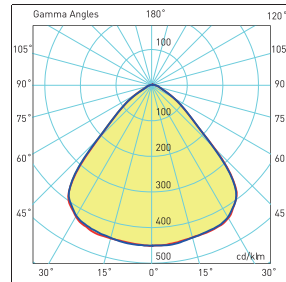

200W / 250W / 300W / 400W

Asymmetric / Asimetrik

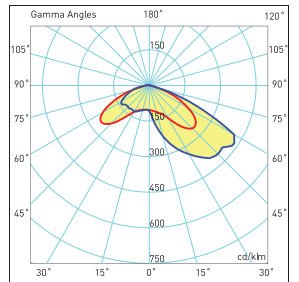

200W / 250W / 300W

180.0 — 0.0 270.0 — 90.0 η : 1000 0 %

Cone Diagram

Konik Diagram

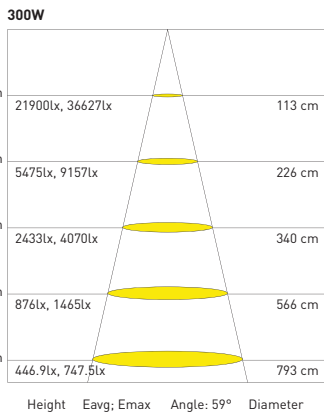

Visit our website for latest product informations and documents.
Güncel ürün bilgi ve belgeleri için web sitemizi ziyaret ediniz.



Floodlights Projektörler

Ria Asymmetric Lens Ria Asimetrik Lens



5 years warranty

IP66, dust and waterproof aluminium body

IP67 ENEC certified driver

100.000h driver lifetime

10kV internal surge protection

30° / 60° / 90° / Asymmetric lens

5 yıl garanti

IP66, toz ve su almaz alüminyum gövde

IP67 ENEC belgeli driver

100.000h driver ömrü

10kV dahili parafudr

30° / 60° / 90° / Asimetrik lens



Mechanical Specifications

Mekanik Özellikler

Body	Gövde	Aluminium	Alüminyum
IP Rating	IP Sınıfı	IP66	
IK Rating Body	IK Gövde Sınıfı	IK10	
Fire Protection	Alev Koruması	650°	
Cable Gland	Kablo Rakor	PG13,5	
Cable	Kablo	3x1,5mm ²	
RAL Code	Ral Kodu	9005	
Mounting Type	Montaj Tipi	Pole / Ground	Direk / Zemin

Optical Specifications

Optik Özellikler

Light Source	Işık Kaynağı	Power LED	
Reflector	Reflektör	-	
Lens	Lens	PMMA	
Diffuser	Difüzör	Tempered Glass	Temperli Cam
CRI		>80	
Colour Temperature	Renk Sıcaklığı	3000K / 4000K / 6500K	
Photobiological Risk Group	Fotobiyolojik Risk Grubu	RG01	
Beam Angle	Işık Açısı	Asymmetric / Asimetrik	

Electrical Specifications

Elektriksel Özellikler

Input Voltage	Giriş Gerilimi	220-240Vac
Frequency	Frekans	50-60Hz
Class	Sınıf	I
System Lifetime	Sistem Ömrü	>62.000h
Power Factor	Güç Faktörü	>0,95
Operating Temperature	Çalışma Sıcaklığı	-20°C / 45°C
Standards	Standartlar	60598-2-5, LM79, EN 13032, LM80, EN 62262, EN 60529

Options

Opsiyonlar

DALI		✓
1-10V		✓
Step DIM		✓
1hour Emergency Kit	1 Saat Acil Kit	-
3hour Emergency Kit	3 Saat Acil Kit	-
Electrical Protection	Elektriksel Sınıf	I/II
Microwave Sensor	Radar Sensör	-
RAL Code	RAL Kodu	✓
Marine Painting	Marin Boya	✓

Code No Ürün Kodu	Power Güç (W)	Luminous Flux Işık Akısı (lm)	Colour Temp. Renk Sıcaklığı (K)	Efficacy Etkinlik Faktörü (lm/W)	Dimensions Boyutlar (mm) axbxc	Pcs / Pack Koli Adedi	Package Vol. Koli Hacmi (m ³)	Package Weight Koli Ağırlığı (kg)
110770	200	28800	6500	144	400x418x100	1	0,018	6
110771	250	34750	6500	139	400x418x100	1	0,018	6
110772	300	40500	6500	135	400x418x100	1	0,018	6

Product codes can change by the kelvins, dimensions, or options. Please get in contact with the sales team.

Technical values has tolerance +/-%7 by the operating conditions.

Ürün kodları kelvin, boyut ve opsiyonlar için değişebilir. Lütfen satış ekibi ile iletişime geçiniz.

Teknik sonuçlar çalışma koşullarına bağlı olarak +/-%7 toleransa sahiptir.



Technical Drawing

Teknik Çizim

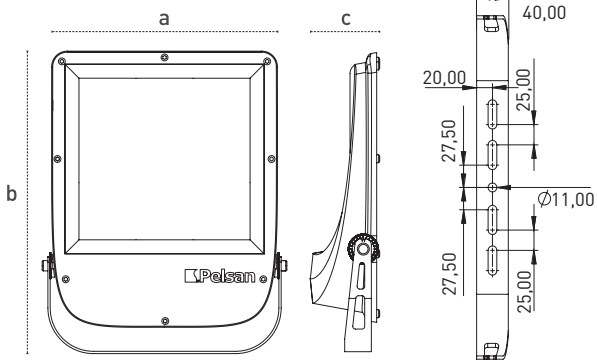

Light Distribution Curve

Işık Şiddeti Dağılım Eğrisi

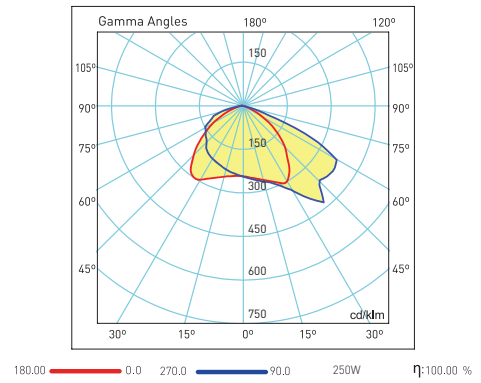

Cone Diagram

Konik Diagram

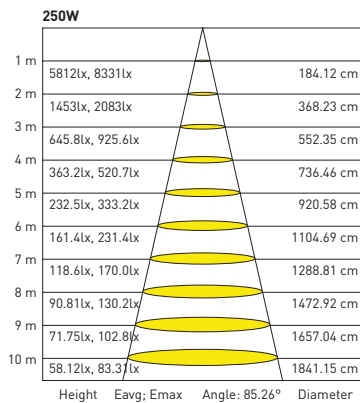

Visit our website for latest product informations and documents.
Güncel ürün bilgi ve belgeleri için web sitemizi ziyaret ediniz.



Floodlights Projektörler Ria Med G2



5 years warranty

IP66, dust and waterproof aluminium body

IP67 ENEC certified driver

100.000h driver lifetime

10kV internal surge protection

5 yıl garanti

IP66, toz ve su almaz alüminyum gövde

IP67 ENEC belgeli driver

100.000h driver ömrü

10kV dahili parafudr



Mechanical Specifications

Mekanik Özellikler

Body	Gövde	Aluminium	Alüminyum
IP Rating	IP Sınıfı	IP66	
IK Rating Body	IK Gövde Sınıfı	IK10	
Fire Protection	Alev Koruması	650°	
Cable Gland	Kablo Rakor	PG11	
Cable	Kablo	3x1mm ²	
RAL Code	Ral Kodu	7043	
Mounting Type	Montaj Tipi	Pole/Ground	Direk/Zemin

Optical Specifications

Optik Özellikler

Light Source	Işık Kaynağı	Power LED	
Reflector	Reflektör	-	
Lens	Lens	PMMA	
Diffuser	Difüzör	Tempered Glass	Temperli Cam
CRI		>80	
Colour Temperature	Renk Sıcaklığı	3000K / 4000K / 6500K	
Photobiological Risk Group	Fotobiyolojik Risk Grubu	RG01	
Beam Angle	Işık Açısı	30° / 60° / 90° / Asymmetric	

Electrical Specifications

Elektriksel Özellikler

Input Voltage	Giriş Gerilimi	220-240Vac
Frequency	Frekans	50-60Hz
Class	Sınıf	I
System Lifetime	Sistem Ömrü	>62.000h
Power Factor	Güç Faktörü	>0,95
Operating Temperature	Çalışma Sıcaklığı	-20°C / +45°C
Standards	Standartlar	60598-2-5, LM79, EN 13032, LM80, EN 62262, EN 60529

Options

Opsiyonlar

DALI		✓
1-10V		✓
Step DIM		✓
1hour Emergency Kit	1 Saat Acil Kit	-
3hour Emergency Kit	3 Saat Acil Kit	-
Electrical Protection	Elektriksel Sınıf	I/II
Microwave Sensor	Radar Sensör	-
RAL Code	RAL Kodu	✓
Marine Painting	Marin Boya	✓

Code No Ürün Kodu	Power Güç (W)	Luminous Flux Işık Akısı (lm)	Colour Temp. Renk Sıcaklığı (K)	Efficacy Etkinlik Faktörü (lm/W)	Dimensions Boyutlar (mm) axbxc	Pcs / Pack Koli Adedi	Package Vol. Koli Hacmi (m ³)	Package Weight Koli Ağırlığı (kg)
111788	60	8820	6500	147	340x274x66	4	0,033	15,05
111785	80	11360	6500	142	340x274x66	4	0,033	15,05
111660	100	13800	6500	138	340x274x66	4	0,033	15,05
111666	150	19050	6500	127	340x274x66	4	0,033	15,05
116136	200	26000	6500	130	340x274x66	4	0,033	15,05

Product codes can change by the kelvins, dimensions, or options. Please get in contact with the sales team. Ürün kodları kelvin, boyut ve opsiyonlar için değişebilir. Lütfen satış ekibi ile iletişime geçiniz. Technical values has tolerance +-%7 by the operating conditions. Teknik sonuçlar çalışma koşullarına bağlı olarak +-%7 toleransa sahiptir.

All your lighting needs in one adress.
Tüm aydınlatma ihtiyaçlarınız için tek adres.



Technical Drawing

Teknik Çizim

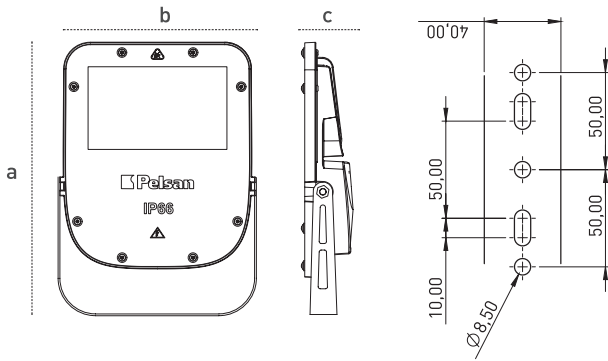

Light Distribution Curve

Işık Şiddeti Dağılım Eğrisi

30°

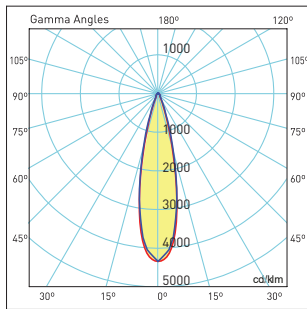

60W / 80W / 100W

60°

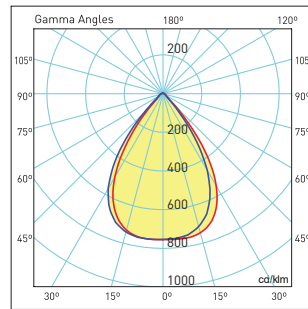

60W / 80W / 100W

90°

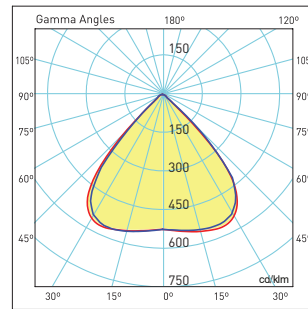

60W / 80W / 100W / 125W / 150W / 200W

Asimetrik

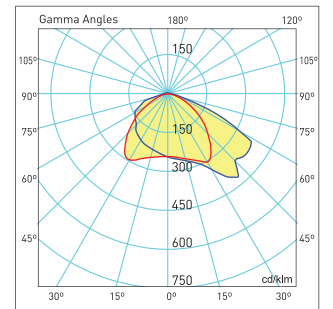

60W / 80W / 100W

Visit our website for latest product informations and documents.
Güncel ürün bilgi ve belgeleri için web sitemizi ziyaret ediniz.



Floodlights Projektörler Sterio



Full range 50W-450W
IP66, dust and waterproof aluminium body
IK10, high impact resistance body
Intagrated driver

Tam ürün gamı 50W-450W
IP66, toz ve su almaz
Yüksek darbe dayanımı, IK10 gövde
Dahili sürücü



Mechanical Specifications Mekanik Özellikler

Body Gövde	Aluminium Alüminyum
IP Rating IP Sınıfı	IP66
IK Rating Body IK Gövde Sınıfı	IK10
Fire Protection Alev Koruması	-
Cable Gland Kablo Rakor	M16
Cable Kablo	3x1mm ²
RAL Code Ral Kodu	7043
Mounting Type Montaj Tipi	Pole/Ground Direk/Zemin

Optical Specifications Optik Özellikler

Light Source Işık Kaynağı	Mid Power LED
Reflector Reflektör	-
Lens Lens	-
Diffuser Difüzör	Tempered Glass Temperli Cam
CRI	>80
Colour Temperature Renk Sıcaklığı	5700K
Photobiological Risk Group Fotobiyolojik Risk Grubu	RG01
Beam Angle Işık Açısı	135°

Electrical Specifications Elektriksel Özellikler

Input Voltage Giriş Gerilimi	220-240Vac
Frequency Frekans	50-60Hz
Class Sınıf	I
System Lifetime Sistem Ömrü	>30.000h
Power Factor Güç Faktörü	>0,90
Operating Temperature Çalışma Sıcaklığı	-20°C / 45°C
Standards Standartlar	60598-2-5, LM79, EN 13032, LM80, EN 62262, EN 60529

Options Opsiyonlar

DALI	-
1-10V	-
Step DIM	-
1hour Emergency Kit 1 Saat Acil Kit	-
3hour Emergency Kit 3 Saat Acil Kit	-
Electrical Protection Elektriksel Sınıf	-
Microwave Sensor Radar Sensör	-
RAL Code RAL Kodu	✓
Marine Painting Marin Boya	✓

Code No Ürün Kodu	Power Güç (W)	Luminous Flux Işık Akısı (lm)	Colour Temp. Renk Sıcaklığı (K)	Efficacy Etkinlik Faktörü (lm/W)	Dimensions Boyutlar (mm) axbxc	Pcs / Pack Koli Adedi	Package Vol. Koli Hacmi (m ³)	Package Weight Koli Ağırlığı (kg)
109787	50	5000	5700	100	225x195x59	6	0,03	8,75
109666	100	10000	5700	100	225x365x85	4	0,04	10
109536	200	20000	5700	100	415x360x85	1	0,017	6
109537	300	30000	5700	100	415x540x85	1	0,027	8
109538	450	45000	5700	100	795x390x85	1	0,035	11

Product codes can change by the kelvins, dimensions, or options. Please get in contact with the sales team. Ürün kodları kelvin, boyut ve opsiyonlar için değişebilir. Lütfen satış ekibi ile iletişime geçiniz. Technical values has tolerance +-%7 by the operating conditions. Teknik sonuçlar çalışma koşullarına bağlı olarak +-%7 toleransa sahiptir.

All your lighting needs in one adress.
Tüm aydınlatma ihtiyaçlarınız için tek adres.



Technical Drawing Teknik Çizim

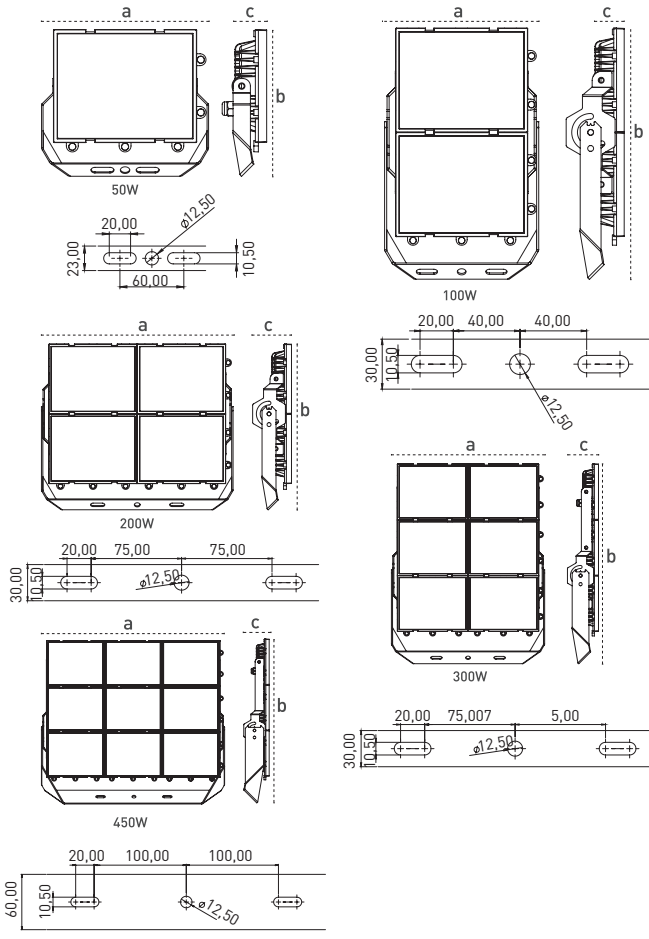

Light Distribution Curve Işık Şiddeti Dağılım Eğrisi

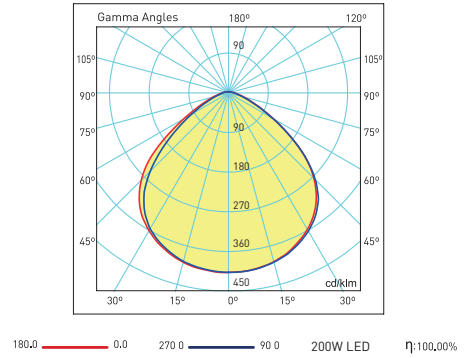

Cone Diagram Konik Diagram

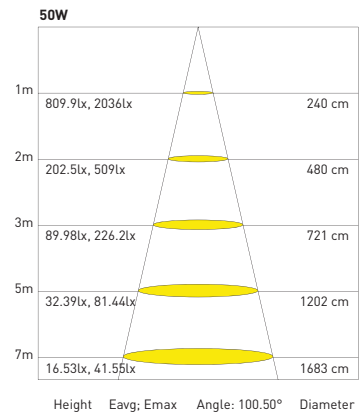

Visit our website for latest product informations and documents.
Güncel ürün bilgi ve belgeleri için web sitemizi ziyaret ediniz.



Floodlights Projektörler Lecto



One to one replacement warranty
Cost effective solution
Slim modern design
Full range 50W-500W
5kV internal surge protection (50 – 300W)
10kV internal surge protection (400- 500W)

Birebir değişim garantisi
Ekonomik fiyat
Slim modern tasarım
Tam ürün gamı 50W-500W
5kV dahili parafudr (50-300W)
10kV dahili parafudr (400-500W)



Mechanical Specifications

Mekanik Özellikler

Body	Gövde	Aluminium	Aluminyum
IP Rating	IP Sınıfı	IP65	
IK Rating	IK Gövde Sınıfı	IK08	
Fire Protection	Alev Koruması	650°C	
Cable Gland	Kablo Rakor	PG7	
Cable	Kablo	3x1mm ²	
RAL Code	Ral Kodu	9005	
Mounting Type	Montaj Tipi	Pole/Ground	
		Direk/Zemin	

Optical Specifications

Optik Özellikler

Light Source	Işık Kaynağı	Mid Power LED
Reflector	Reflektör	-
Lens	Lens	-
Diffuser	Difüzör	Tempered Glass
		Temperli Cam
CRI		>70
Colour Temperature	Renk Sıcaklığı	5000K
Photobiological Risk Group	Fotobiyolojik Risk Grubu	RG01
Beam Angle	Işık Açısı	120°

Electrical Specifications

Elektriksel Özellikler

Input Voltage	Giriş Gerilimi	220-240Vac
Frequency	Frekans	50-60Hz
Class	Sınıf	I
System Lifetime	Sistem Ömrü	>30.000h
Power Factor	Güç Faktörü	>0,90
Operating Temperature	Çalışma Sıcaklığı	-20°C / 45°C
Standards	Standartlar	60598-2-5, LM79, EN 13032, LM80, EN 62262, EN 60529

Options

Opsiyonlar

DALI		-
1-10V		-
Step DIM		-
1hour Emergency Kit	1 Saat Acil Kit	-
3hour Emergency Kit	3 Saat Acil Kit	-
Electrical Protection	Elektriksel Sınıf	-
Microwave Sensor	Radar Sensör	-
RAL Code	RAL Kodu	-
Marine Painting	Marin Boya	-

Code No Ürün Kodu	Power Güç (W)	Luminous Flux Işık Akısı (lm)	Colour Temp. Renk Sıcaklığı (K)	Efficacy Etkinlik Faktörü (lm/W)	Dimensions Boyutlar (mm) axbxc	Pcs / Pack Koli Adedi	Package Vol. Koli Hacmi (m ³)	Package Weight Koli Ağırlığı (kg)
109304	50	5000	5000	100	245x190x33	6	0,017	7
109305	100	10000	5000	100	320x268x33	4	0,02	7,5
109306	150	15000	5000	100	348x256x33	6	0,04	15
111284	200	20000	5000	100	420x320x35	4	0,03	12
114120	300	30000	5000	100	470x335x45	4	0,04	17
115485	400	40000	5000	100	550x395x60	1	0,02	6,7
115484	500	50000	5000	100	605x460x65	1	0,02	10,5

Product codes can change by the kelvins, dimensions, or options. Please get in contact with the sales team. Ürün kodları kelvin, boyut ve opsiyonlar için değişebilir. Lütfen satış ekibi ile iletişime geçiniz. Technical values has tolerance +-%7 by the operating conditions. Teknik sonuçlar çalışma koşullarına bağlı olarak +-%7 toleransa sahiptir.

All your lighting needs in one adress.
Tüm aydınlatma ihtiyaçlarınız için tek adres.



Technical Drawing
Teknik Çizim

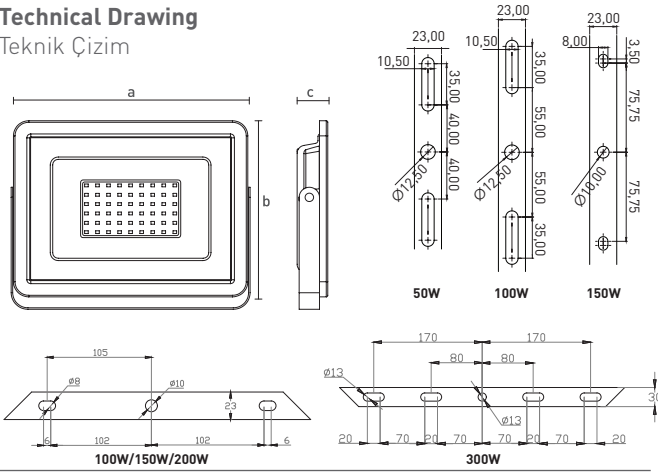

Light Distribution Curve
Işık Şiddeti Dağılım Eğrisi

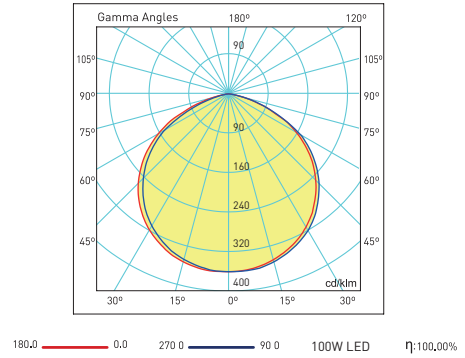

Cone Diagram
Konik Diagram

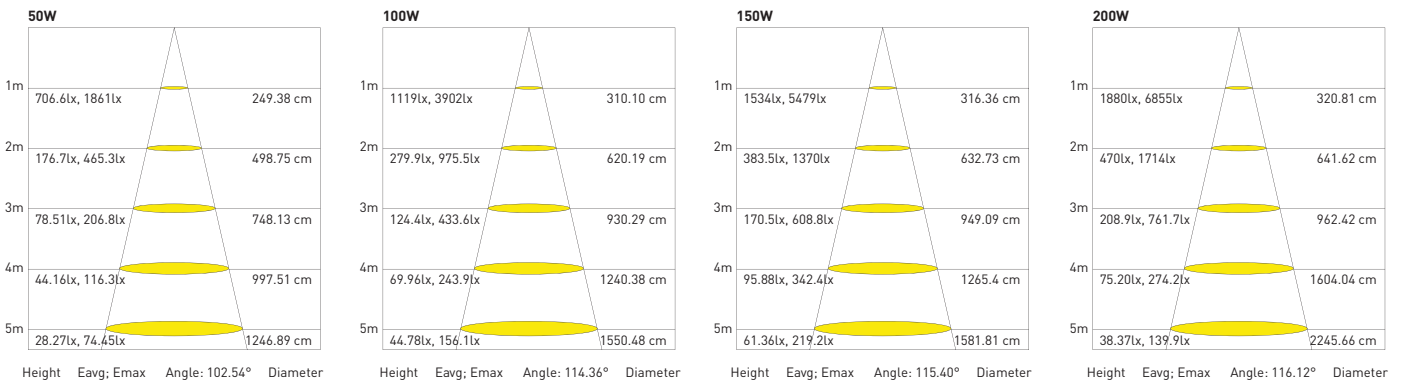

Visit our website for latest product informations and documents.
Güncel ürün bilgi ve belgeleri için web sitemizi ziyaret ediniz.



Pelsan



All your lighting needs in one address.
Tüm aydınlatma ihtiyaçlarınız için tek adres.

www.pelsan.com.tr
info@pelsan.com.tr | export@pelsan.com.tr

HEAD OFFICE
GENEL MERKEZ

Çerkeşli O.S.B.
İmes 5. Cadde No:12
Dilovası / Kocaeli - TÜRKİYE



/PelsanAydınlatma



pelsan-aydinlatma



pelsan aydinlatma



/pelsanaydinlatma



/PelsanLight

T : +9(0850) 460 75 76

F : +9(0216) 364 60 15