



INDUSTRIAL LUMINAIRES

2024

www.pelsan.com.tr



Since
1982



More than
3500 SKU



500
Employees



5 million luminaire
production capacity per year



Factory

● Electronic Assembly Line

● Plastic Injection Moulding Area

● Semi-finished Goods Process Area

● Moulding Area

● Diffuser Treatment Area

● Landscape Lighting Fixture Parts
Manufacturing Area

● Glass Reinforced
Polyester (GRP) Product
Manufacturing Area

● Powder Coating &
Painting Area

● Assembly Line

● Office



30000 ^{m²} **Manufacturing Zone**

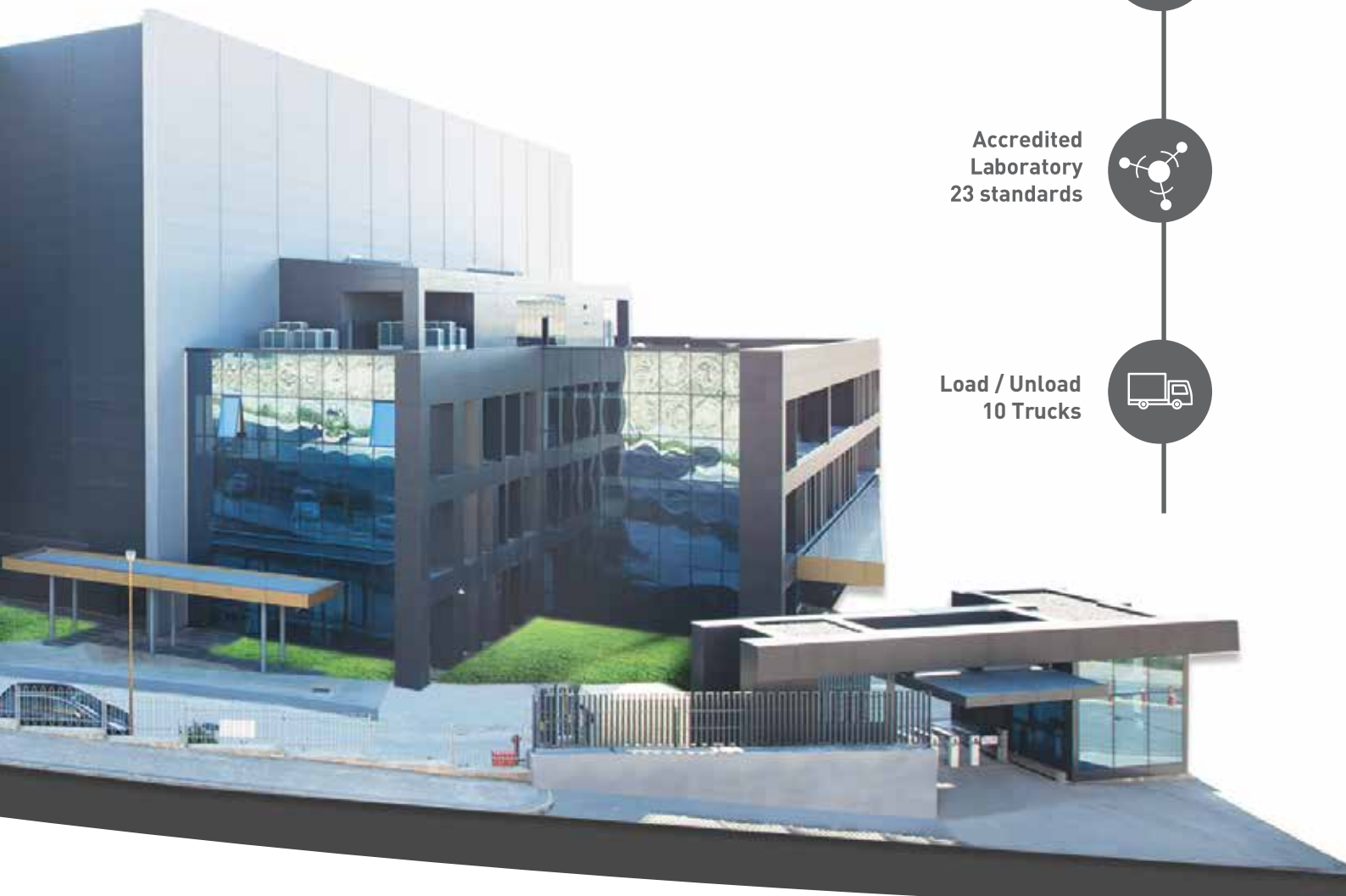

R&D Center
15 Engineers



Accredited Laboratory
23 standards



Load / Unload
10 Trucks

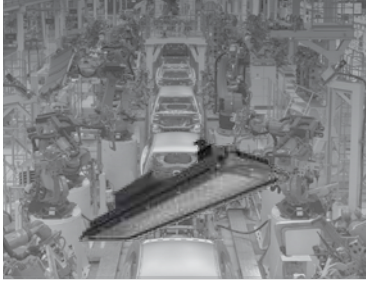

				
Type Tip		Cronto	Etna G2	Hima G2
Lumen Package Lümen Paketi		22.350lm 54.800lm	13.300lm 38.400lm	9.000lm 17.250lm
Power Güç		150W-400W	100W-300W	75W-150W
Efficacy Etkinlik Faktörü		Up to 149lm/W	Up to 134lm/W	Up to 125lm/W
Body Gövde		Aluminium Alüminyum	Anodized Aluminium	Aluminium Alüminyum
Lifetime Ömrü		>72,000h	>50,000h	>50,000h
Warranty Garanti		5 Year / Yıl	5 Year / Yıl	5 Year / Yıl
Optic Optik		4 type lens	2 type reflector	1 type
OPTIONS OPSİYONLAR	Emergency Unit	✓	✓	✓
	DALI	✓	✓	✓
	1-10V	✓	✓	✓
	Sensor	✓	✓	✓
	Automation	✓	✓	✓
APPLICATION FIELDS	Heavy Industries Ağır Sanayi Tesisleri	✓	✓	
	Industrial Plants Endüstriyel Tesisler	✓	✓	✓
	Indoor Sports Facilities Kapalı Spor Salonları	✓	✓	✓
	Warehouses Depolar	✓	✓	✓
	Workshops Atölyeler	✓	✓	✓



Sia	Castor G3	Monte G2	Neta
15.500lm 28.000lm	11.550lm 28.400lm	11.500lm 18.450lm	15.000lm 28.400lm
100W-200W	75W-200W	100W-150W	100W-200W
Up to 155lm/W	Up to 154lm/W	Up to 123m/W	Up to 150lm/W
Aluminium Alüminyum	Aluminium Alüminyum	Aluminium Alüminyum	Metal
>50,000h	>62,000h	>30,000h	>50,000h
5 Year / Yıl	5 Year / Yıl	2 Year / Yıl	2 Year / Yıl
4 type lens	2 type lens	1 type	4 type lens
✓	✓	✓	✓
✓	✓		✓
✓	✓		✓
✓	✓		✓
✓	✓		✓
✓	✓		
✓	✓		
✓	✓	✓	
✓	✓	✓	
✓	✓	✓	



Highbay Luminaires Yüksek Tavan Armatürleri Cronto

350-400W



150-200W



250-300W



5 years warranty

Cronto designed for hard industrial plants.

IP66/IK10 body

100.000h driver lifetime

10kV internal surge protection

30°/60°/90°/Asymmetric lens

5 yıl garanti

Cronto, ağır ortam koşullarına sahip 7/24 çalışan endüstriyel tesisler için tasarlandı.

IP66/IK10 gövde

100.000h driver ömrü

10kV dahili parafudr

30°/60°/90°/Asimetrik lens



Mechanical Specifications

Mekanik Özellikler

Body	Gövde	Aluminium	Aluminyum
IP Rating	IP Sınıfı	IP66	
IK Rating	IK Gövde Sınıfı	IK10	
Fire Protection	Alev Koruması	650°C	
Cable Gland	Kablo Rakor	M16	
Cable	Kablo	3x1,5mm ²	
RAL Code	Ral Kodu	7043	
Mounting Type	Montaj Tipi	Cable Tray/Busbar/Surface Mounted	Kablo Tavası/Busbar/Sıva Üstü

Optical Specifications

Optik Özellikler

Light Source	Işık Kaynağı	Power LED	
Reflector	Reflektör	-	
Lens	Lens	PMMA	
Diffuser	Difüzör	Tempered Glass	Temperli Cam
CRI		>70	
Colour Temperature	Renk Sıcaklığı	4000K / 5700K / 6500K	
Photobiological Risk Group	Fotobiyolojik Risk Grubu	RG1	
Beam Angle	Işık Açısı	30° / 60° / 90° / Asymmetric	

Electrical Specifications

Elektriksel Özellikler

Input Voltage	Giriş Gerilimi	220-240Vac
Frequency	Frekans	50-60Hz
Class	Sınıf	I
System Lifetime	Sistem Ömrü	>72.000h
Power Factor	Güç Faktörü	>0,95
Operating Temperature	Çalışma Sıcaklığı	-40°C / 55°C
Standards	Standartlar	60598-2-1, LM79, EN 13032, LM80, EN 62262, EN 60529

Options

Opsiyonlar

DALI		✓
1-10V		✓
Step DIM		✓
1hour Emergency Kit	1 Saat Acil Kit	✓
3hour Emergency Kit	3 Saat Acil Kit	✓
Electrical Protection	Elektriksel Sınıf	-
Microwave Sensor	Radar Sensör	✓

Code No Ürün Kodu	Power Güç (W)	Luminous Flux Işık Akısı (lm)	Colour Temp. Renk Sıcaklığı (K)	Efficacy Etkinlik Faktörü (lm/W)	Dimensions Boyutlar (mm) axbxc	Pcs / Pack Koli Adedi	Package Vol. Koli Hacmi (m ³)	Package Weight Koli Ağırlığı (kg)
111333	150	22350	5700	149	555x230x135	1	0,023	12
111334	200	28800	5700	144	555x230x135	1	0,023	12
111331	250	36000	5700	144	655x230x135	1	0,027	15
111332	300	42300	5700	141	655x230x135	1	0,027	15
111335	350	48650	5700	139	760x230x135	1	0,032	19
111336	400	54800	5700	137	760x230x135	1	0,032	19

Product codes can change by the kelvins, dimensions, or options. Please get in contact with the sales team. Ürün kodları kelvin, boyut ve opsiyonlar için değişebilir. Lütfen satış ekibi ile iletişime geçiniz. Technical values has tolerance +-%7 by the operating conditions. Teknik sonuçlar çalışma koşullarına bağlı olarak +-%7 toleransa sahiptir.



Technical Drawing

Teknik Çizim

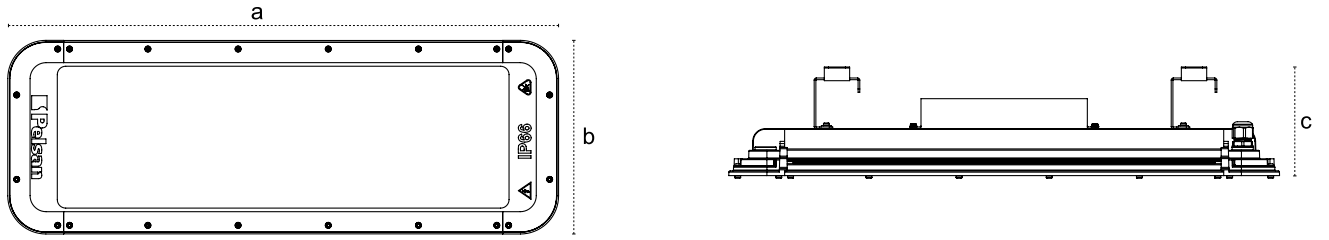

Light Distribution Curve

Işık Şiddeti Dağılım Eğrisi

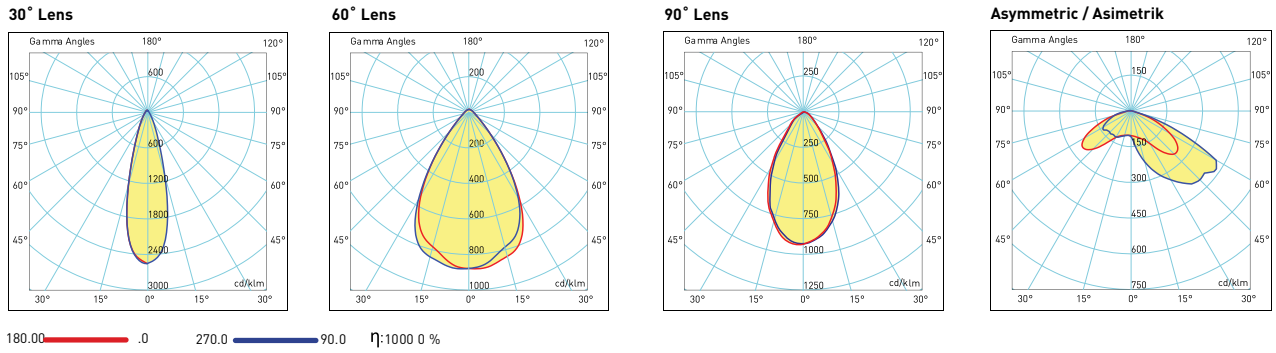

Visit our website for latest product informations and documents.
Güncel ürün bilgi ve belgeleri için web sitemizi ziyaret ediniz.



Highbay Luminaires Yüksek Tavan Armatürleri

Etna G2



5 years warranty

Etna designed for hard industrial plants.

Aluminium body

Up to 133lm/W efficacy

45°/55° option

5 yıl garanti

Etna ağır ortam koşullarına sahip 7/24 çalışan endüstriyel tesisler için tasarlandı.

Alüminyum gövde

133lm/W'a varan verimlilik

45°/55° opsiyon

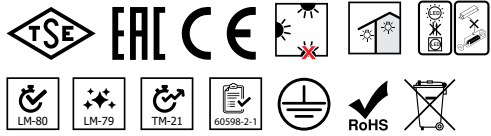

Mechanical Specifications Mekanik Özellikler

Body	Gövde	Anodized Aluminium
		Anodize Alüminyum
IP Rating	IP Sınıfı	IP65
IK Rating	IK Gövde Sınıfı	IK10
Fire Protection	Alev Koruması	650°C
Cable Gland	Kablo Rakor	PG11
Cable	Kablo	3x1mm ²
RAL Code	Ral Kodu	-
Mounting Type	Montaj Tipi	Cable Tray/Busbar/Surface Mounted
		Kablo Tavası / Busbar / Sıva Üstü

Optical Specifications Optik Özellikler

Light Source	Işık Kaynağı	Mid Power LED
Reflector	Reflektör	Aluminium Alüminyum
Lens	Lens	-
Diffuser	Difüzör	Tempered Glass Temperli Cam
CRI		>80
Colour Temperature	Renk Sıcaklığı	4000K - 5700K - 6500K
Photobiological Risk Group	Fotobiyolojik Risk Grubu	RG1
Beam Angle	Işık Açısı	45°/55°

Electrical Specifications Elektriksel Özellikler

Input Voltage	Giriş Gerilimi	220-240Vac
Frequency	Frekans	50-60Hz
Class	Sınıf	I
System Lifetime	Sistem Ömrü	>50.000h
Power Factor	Güç Faktörü	>0,95
Operating Temperature	Çalışma Sıcaklığı	-20°C / 45°C
Standards	Standartlar	EN 60598-2-1, LM79, EN 13032, LM80, EN 62262, EN 60529

Options Opsiyonlar

DALI		✓
1-10V		✓
Step DIM		-
1hour Emergency Kit	1 Saat Acil Kit	✓
3hour Emergency Kit	3 Saat Acil Kit	✓
Electrical Protection	Elektriksel Sınıf	I/II
Microwave Sensor	Radar Sensör	✓

Technical Drawing

Teknik Çizim

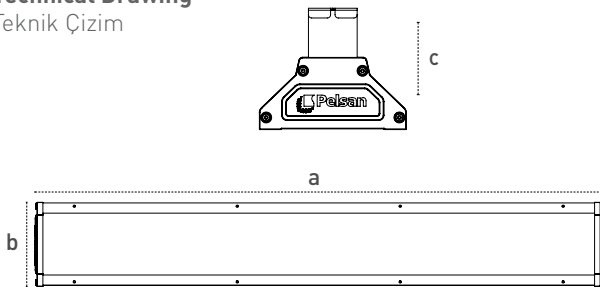

Highbay Luminaire Busbar Assembly Set

Yüksek Tavan Busbar Askı Takımı

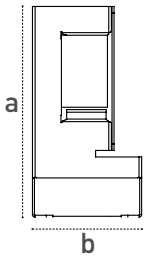

Code No Ürün Kodu	Dimensions Boyutlar (mm) axb
316387	150x69

Light Distribution Curve

Işık Şiddeti Dağılım Eğrisi

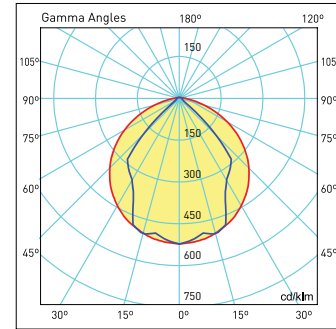

Wide Angle
Geniş Aç

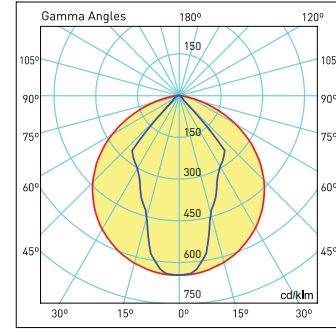

Narrow Angle
Dar Aç

180.00 .0 270.0 90.0 100W LED η :100.00 %

Code No Ürün Kodu	Type Tip	Power Güc (W)	Luminous Flux Işık Akısı (lm)	Colour Temp. Renk Sıcaklığı (K)	Efficacy Etkinlik Faktörü (lm/W)	Dimensions Boyutlar (mm) axbxc	Pcs / Pack Koli Adedi	Package Vol. Koli Hacmi (m ³)	Package Weight Koli Ağırlığı (kg)
111273	45°	100W	13300	6500K	133	590x86x178	1	0,0164	4,1
111271	45°	150W	19950	6500K	133	870x86x178	1	0,0246	6,3
111269	45°	200W	26800	6500K	134	1150x86x178	1	0,0328	7,9
111258	45°	250W	33250	6500K	133	1430x86x178	1	0,0408	9,8
111256	45°	300W	38400	6500K	128	1430x86x178	1	0,0408	9,8
111272	55°	100W	13300	6500K	133	590x86x178	1	0,0164	4,1
111270	55°	150W	19950	6500K	133	870x86x178	1	0,0246	6,3
111259	55°	200W	26800	6500K	134	1150x86x178	1	0,0328	7,9
111257	55°	250W	33250	6500K	133	1430x86x178	1	0,0408	9,8
111255	55°	300W	38400	6500K	128	1430x86x178	1	0,0408	9,8

Product codes can change by the kelvins, dimensions, or options. Please get in contact with the sales team.

Technical values has tolerance +-7% by the operating conditions.

Ürün kodları kelvin, boyut ve opsiyonlar için değişebilir. Lütfen satış ekibi ile iletişime geçiniz.

Teknik sonuçlar çalışma koşullarına bağlı olarak +-7% toleransa sahiptir.

Visit our website for latest product informations and documents.

Güncel ürün bilgi ve belgeleri için web sitemizi ziyaret ediniz.



Highbay Luminaires Yüksek Tavan Armatürleri Hima G2

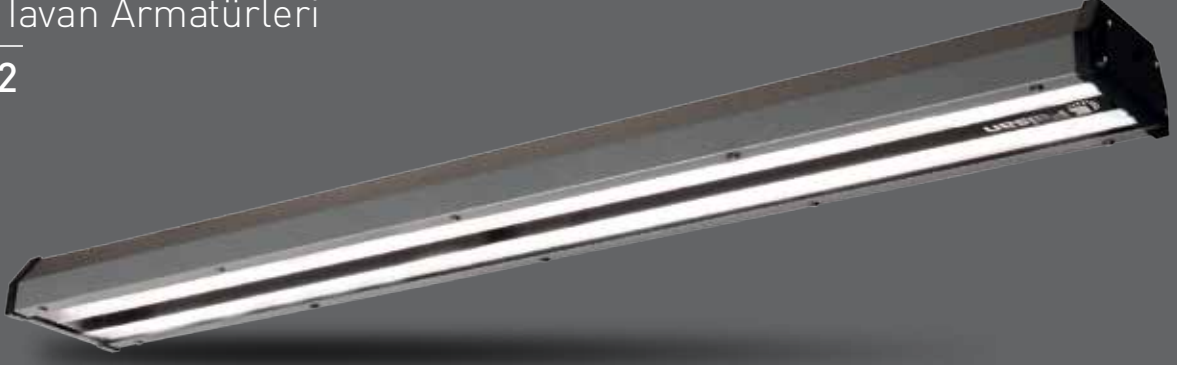

It has the shortest payback period thanks to the high-efficiency factor and affordable price.

5 years warranty

Aluminium body, up to 125lm/W efficacy

Yüksek etkinlik faktörü ve uygun fiyatı ile en hızlı amortisman süresine sahiptir.

5 yıl garanti

Alüminyum gövde, 125lm/W varan verimlilik



Code No Ürün Kodu	Power Güç (W)	Luminous Flux Işık Akısı (lm)	Colour Temp. Renk Sıcaklığı (K)	Efficacy Etkinlik Faktörü (lm/W)	Dimensions Boyutlar (mm) axbxc	Pcs / Pack Koli Adedi	Package Vol. Koli Hacmi (m ³)	Package Weight Koli Ağırlığı (kg)
114394	75	9075	6500	121	585x155x80	1	0,005	3
111072	75	9000	6500	120	865x155x80	1	0,007	4,5
111073	100	11500	6500	115	865x155x80	1	0,007	4,5
111065	125	15625	6500	125	1145x155x80	1	0,010	6
111066	150	17250	6500	115	1145x155x80	1	0,010	6

Product codes can change by the kelvins, dimensions, or options. Please get in contact with the sales team.

Technical values has tolerance +/-%7 by the operating conditions.

Ürün kodları kelvin, boyut ve opsiyonlar için değişebilir. Lütfen satış ekibi ile iletişime geçiniz.

Teknik sonuçlar çalışma koşullarına bağlı olarak +/-%7 toleransa sahiptir.

Mechanical Specifications

Mekanik Özellikler

Body	Gövde	Aluminium	Alüminyum
IP Rating	IP Sınıfı	IP65	
IK Rating	IK Gövde Sınıfı	IK08	
Fire Protection	Alev Koruması	650°C	
Cable Gland	Kablo Rakor	PG11	
Cable	Kablo	3x1mm ²	
RAL Code	Ral Kodu	7043	
Mounting Type	Montaj Tipi	Cable Tray/Busbar/Surface Mounted	Kablo Tavası/Busbar/Sıva Üstü

Optical Specifications

Optik Özellikler

Light Source	Işık Kaynağı	Mid Power LED	
Reflector	Reflektör	Aluminium	Alüminyum
Lens	Lenz	-	
Diffuser	Difüzör	Tempered Glass	Temperli Cam
CRI		>80	
Colour Temperature	Renk Sıcaklığı	3000K / 4000K / 6500K	
Photobiological Risk Group	Fotobiyolojik Risk Grubu	RG1	
Beam Angle	Işık Açısı	120°	

Electrical Specifications

Elektriksel Özellikler

Input Voltage	Giriş Gerilimi	220-240Vac	
Frequency	Frekans	50-60Hz	
Class	Sınıf	I	
System Lifetime	Sistem Ömrü	>50.000h	
Power Factor	Güç Faktörü	>0,95	
Operating Temperature	Çalışma Sıcaklığı	-20°C / 45°C	
Standards	Standartlar	60598-2-1, LM79, EN 13032, LM80, EN 62262, EN 60529	

Options

Opsiyonlar

DALI		✓
1-10V		✓
Step DIM		-
1hour Emergency Kit	1 Saat Acil Kit	✓
3hour Emergency Kit	3 Saat Acil Kit	✓
Electrical Protection	Elektriksel Sınıf	-
Microwave Sensor	Radar Sensör	✓



Specification of Highbay Sensor

Yüksek Tavan Sensörü Özellikleri

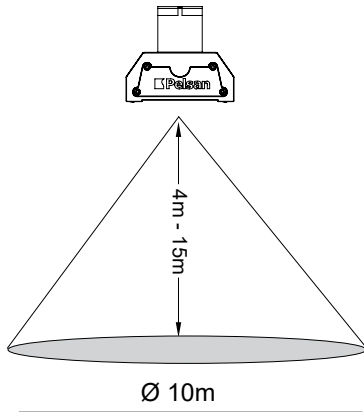

Light Distribution Curve

Işık Şiddeti Dağılım Eğrisi

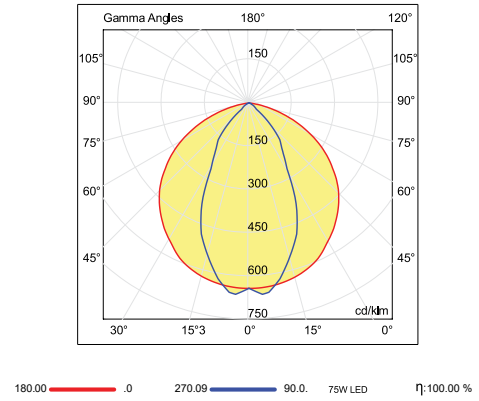

Technical Drawing

Teknik Çizim

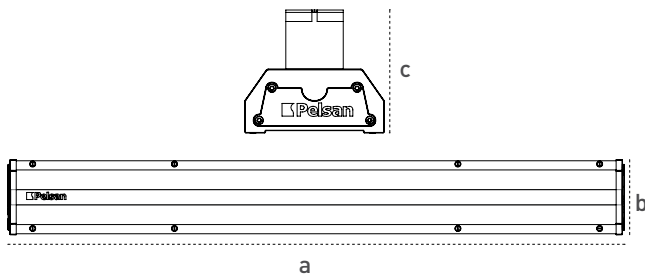

Highbay Luminaire Busbar Assembly Set

Yüksek Tavan Busbar Askı Takımı

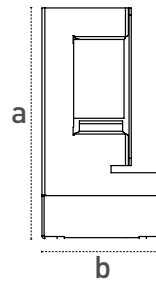

Code No Ürün Kodu	Dimensions Boyutlar (mm) axb
316387	150x69



Highbay Luminaires Yüksek Tavan Armatürleri Sia G2



5 years warranty
100.000h driver lifetime
10kV internal surge protection
30°/60°/90°/Asymmetric Lens
IP66, IK10 Body

5 yıl garanti
100.000h driver ömrü
30°/60°/90°/Asimetrik Lens
10kV dahili parafudr
IP66, IK10 gövde



Mechanical Specifications

Mekanik Özellikler

Body	Gövde	Aluminium	Alüminyum
IP Rating	IP Sınıfı	IP66	
IK Rating	IK Gövde Sınıfı	IK10	
Fire Protection	Alev Koruması	650°C	
Cable Gland	Kablo Rakor	PG11	
Cable	Kablo	3x1.5mm ²	
RAL Code	Ral Kodu	7043	
Mounting Type	Montaj Tipi	Surface Mounted	Sıva Üstü

Optical Specifications

Optik Özellikler

Light Source	Işık Kaynağı	Mid Power LED	
Reflector	Reflektör	-	
Lens	Lens	PMMA	
Diffuser	Difüzör	Tempered Glass	Temperli Cam
CRI		>70	
Colour Temperature	Renk Sıcaklığı	3000K / 4000K / 6500K	
Photobiological Risk Group	Fotobiyolojik Risk Grubu	RG1	
Beam Angle	Işık Açısı	30°/60°/90°/Asymmetric	

Electrical Specifications

Elektriksel Özellikler

Input Voltage	Giriş Gerilimi	220-240Vac
Frequency	Frekans	50-60Hz
Class	Sınıf	I
System Lifetime	Sistem Ömrü	>50.000h
Power Factor	Güç Faktörü	>0,95
Operating Temperature	Çalışma Sıcaklığı	-20°C / 40°C
Standards	Standartlar	60598-2-1, LM79, EN 13032, LM80, EN 62262, EN 60529

Options

Opsiyonlar

DALI		✓
1-10V		✓
Step DIM		-
1hour Emergency Kit	1 Saat Acil Kit	✓
3hour Emergency Kit	3 Saat Acil Kit	✓
Electrical Protection	Elektriksel Sınıf	-
Microwave Sensor	Radar Sensör	-
Ral Code	Ral Kodu	✓
Marine Painting	Marin Boya	-

Code No Ürün Kodu	Power Güç (W)	Luminous Flux Işık Akısı (lm)	Colour Temp. Renk Sıcaklığı (K)	Efficacy Etkinlik Faktörü (lm/W)	Dimensions Boyutlar (mm) a x b x c	Pcs / Pack Koli Adedi	Package Vol. Koli Hacmi (m ³)	Package Weight Koli Ağırlığı (kg)
115560	100	15500	6500	155	341x341x135	1	0,01	4,84
115561	150	22500	6500	150	341x341x135	1	0,01	4,84
115562	200	28000	6500	140	341x341x135	1	0,01	4,84

Product codes can change by the kelvins, dimensions, or options. Please get in contact with the sales team.

Technical values has tolerance +-7% by the operating conditions.

Ürün kodları kelvin, boyut ve opsiyonlar için değişebilir. Lütfen satış ekibi ile iletişime geçiniz.

Teknik sonuçlar çalışma koşullarına bağlı olarak +-7% toleransa sahiptir.



Technical Drawing

Teknik Çizim

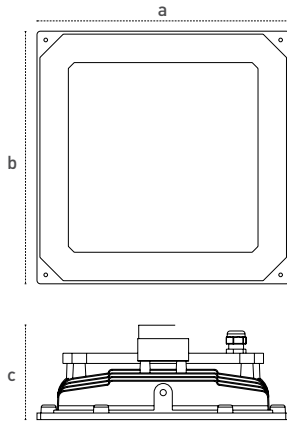

Light Distribution Curve

Işık Şiddeti Dağılım Eğrisi

30°

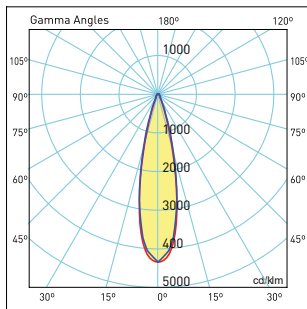

60°

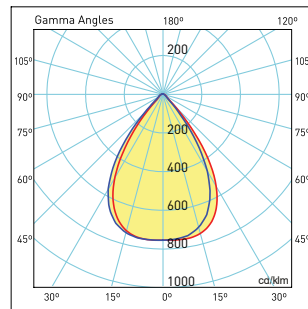

90°

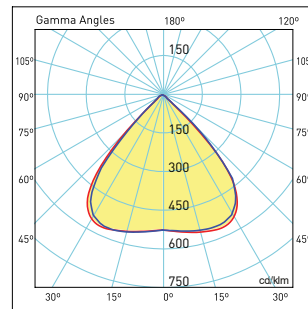

Asimetrik

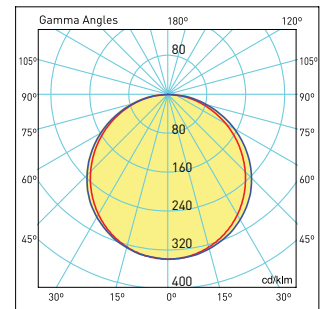

Visit our website for latest product informations and documents.
Güncel ürün bilgi ve belgeleri için web sitemizi ziyaret ediniz.



Highbay Luminaires Yüksek Tavan Armatürleri Castor G3



75W / 100W



150W / 200W

5 years warranty
100.000h driver lifetime
6kV internal surge protection
45°/90° Lens
Microwave sensor option

5 yıl garanti
100.000h driver ömrü
45°/90° Lens
6kV dahili parafudr
Sensör uygulaması



Mechanical Specifications

Mekanik Özellikler

Body	Gövde	Aluminium	Alüminyum
IP Rating	IP Sınıfı	IP65	
IK Rating	IK Gövde Sınıfı	IK08	
Fire Protection	Alev Koruması	650°C	
Cable Gland	Kablo Rakor	PG9	
Cable	Kablo	3x1mm ²	
RAL Code	Ral Kodu	7043	
Mounting Type	Montaj Tipi	Pendant	Sarkıt

Optical Specifications

Optik Özellikler

Light Source	Işık Kaynağı	Mid Power LED
Reflector	Reflektör	-
Lens	Lens	PC
Diffuser	Difüzör	-
CRI		>80
Colour Temperature	Renk Sıcaklığı	3000K / 4000K / 6500K
Photobiological Risk Group	Fotobiyolojik Risk Grubu	RG1
Beam Angle	Işık Açısı	45°/90°

Electrical Specifications

Elektriksel Özellikler

Input Voltage	Giriş Gerilimi	220-240Vac
Frequency	Frekans	50-60Hz
Class	Sınıf	I
System Lifetime	Sistem Ömrü	>62.000h
Power Factor	Güç Faktörü	>0,95
Operating Temperature	Çalışma Sıcaklığı	-40°C / 55°C
Standards	Standartlar	60598-2-1, LM79, EN 13032, LM80, EN 62262, EN 60529

Options

Opsiyonlar

DALI		✓
1-10V		✓
Step DIM		-
1hour Emergency Kit	1 Saat Acil Kit	✓
3hour Emergency Kit	3 Saat Acil Kit	✓
Electrical Protection	Elektriksel Sınıf	-
Microwave Sensor	Radar Sensör	✓

Code No Ürün Kodu	Type Tip	Power Güç (W)	Luminous Flux Işık Akısı (lm)	Colour Temp. Renk Sıcaklığı (K)	Efficacy Etkinlik Faktörü (lm/W)	Dimensions Boyutlar (mm) axbxc	Pcs / Pack Koli Adedi	Package Vol. Koli Hacmi (m ³)	Package Weight Koli Ağırlığı (kg)
114042	90°	75	11550	5700	154	272x180	6	0,0095	16,8
114043	90°	100	14900	5700	149	272x180	6	0,0095	16,8
114044	90°	150	21900	5700	146	323x186	4	0,0176	12,8
114045	90°	200	28400	5700	142	323x186	4	0,0176	12,8

Product codes can change by the kelvins, dimensions, or options. Please get in contact with the sales team.

Technical values has tolerance +- %7 by the operating conditions.

Ürün kodları kelvin, boyut ve opsiyonlar için değişebilir. Lütfen satış ekibi ile iletişime geçiniz.

Teknik sonuçlar çalışma koşullarına bağlı olarak +- %7 toleransa sahiptir.



Technical Drawing

Teknik Çizim

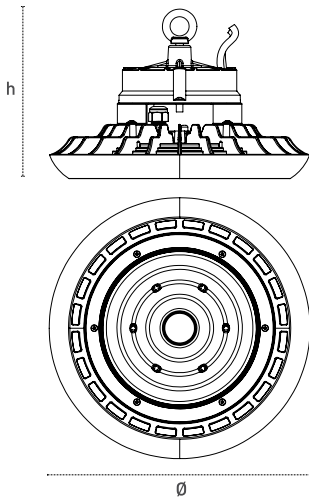

Assembly Set and Anti-Glare Reflector

Askı Takımı ve Kamaşma Önleyici Reflektör

Code No Ürün Kodu	Definition Tanım
325718	Castor G3 Busbar Assembly Set Castor G3 Tavan Busbar Askı Takımı
325458	Castor G3 Anti-Glare Reflector Castor G2 Kamaşma Önleyici Reflektör

Light Distribution Curve

Işık Şiddeti Dağılım Eğrisi

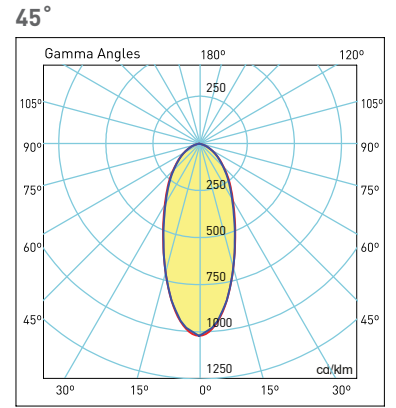

180.00 0.0 270.0 90.0 100.00 %

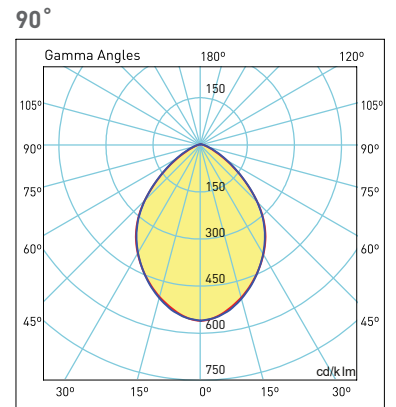

180.00 0.0 270.0 90.0 100.00 %



Highbay Luminaires Yüksek Tavan Armatürleri Monte G2



Cost effective solution
Efficacy up to 123lm/W
IP65, dust and waterproof

Ekonomik fiyat
123lm/W'a varan verimlilik
IP65, toz ve su almaz



Code No Ürün Kodu	Power Güç (W)	Luminous Flux Işık Akısı (lm)	Colour Temp. Renk Sıcaklığı (K)	Efficacy Etkinlik Faktörü (lm/W)	Dimensions Boyutlar (mm) axbxc	Pcs / Pack Koli Adedi	Package Vol. Koli Hacmi (m ³)	Package Weight Koli Ağırlığı (kg)
110569	100	11500	5700	115	272x180	6	0,051	9,6
110570	150	18450	5700	123	323x186	4	0,046	11,6

Product codes can change by the kelvins, dimensions, or options. Please get in contact with the sales team.
Technical values has tolerance +-%7 by the operating conditions.
Ürün kodları kelvin, boyut ve opsiyonlar için değişebilir. Lütfen satış ekibi ile iletişime geçiniz.
Teknik sonuçlar çalışma koşullarına bağlı olarak +-%7 toleransa sahiptir.

Mechanical Specifications Mekanik Özellikler

Body Gövde	Aluminium Alüminyum
IP Rating IP Sınıfı	IP65
IK Rating Body IK Gövde Sınıfı	IK08
Fire Protection Alev Koruması	650°C
Cable Gland Kablo Rakor	PG9
Cable Kablo	3x1mm ²
RAL Code Ral Kodu	7043
Mounting Type Montaj Tipi	Pendant Sarkıt

Optical Specifications Optik Özellikler

Light Source Işık Kaynağı	Mid Power LED
Reflector Reflektör	-
Lens Lens	PC
Diffuser Difüzör	-
CRI	>80
Colour Temperature Renk Sıcaklığı	3000K / 4000K / 6500K
Photobiological Risk Group Fotobiyolojik Risk Grubu	RG1
Beam Angle Işık Açısı	-

Electrical Specifications Elektriksel Özellikler

Input Voltage Giriş Gerilimi	220-240Vac
Frenquency Frekans	50-60Hz
Class Sınıf	I
System Lifetime Sistem Ömrü	>30.000h
Power Factor Güç Faktörü	>0,90
Operating Temperature Çalışma Sıcaklığı	-20°C / 45°C
Standards Standartlar	60598-2-1, EN 62262, EN 60529

Options Opsiyonlar

DALI	-
1-10V	-
Step DIM	-
1hour Emergency Kit 1 Saat Acil Kit	✓
3hour Emergency Kit 3 Saat Acil Kit	✓
Electrical Protection Elektriksel Sınıf	-
Microwave Sensor Radar Sensör	-



Technical Drawing Teknik Çizim

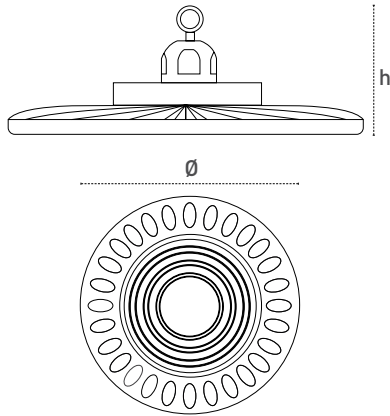

Light Distribution Curve Işık Şiddeti Dağılım Eğrisi

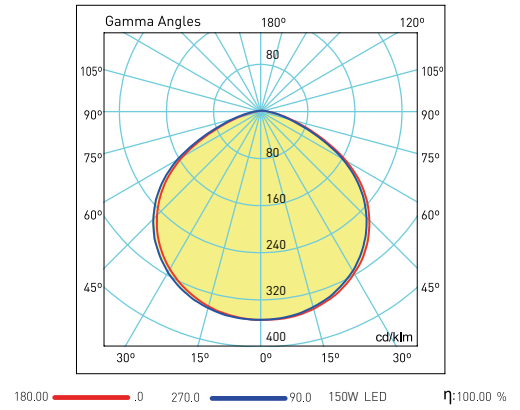

Highbay Luminaires Yüksek Tavan Armatürleri Neta



Neta, especially for professional sport fields
IK10, High impact resistance
30°/60°/90°/asymmetric lens
Anti-glare design, UGR<19
Flicker free
CRI>90 option
Casambi option

Profesyonel spor salonları için, Neta
 IK10, Yüksek darbe dayanımı
 30°/60°/90°/asimetrik lens
 Kamaşma önleyici optik tasarım, UGR<19
 Flicker free
 CRI>90 opsiyonu
 Casambi opsiyonu

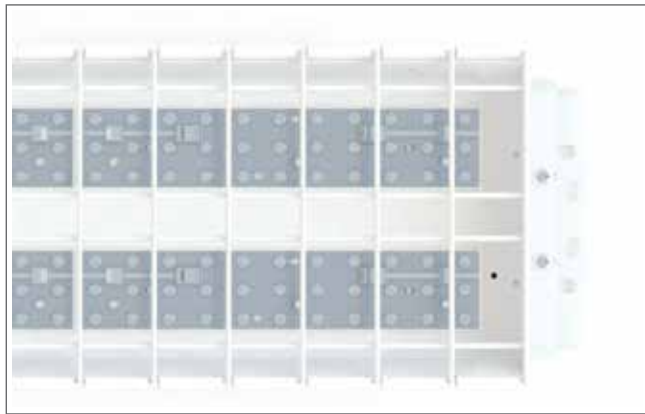
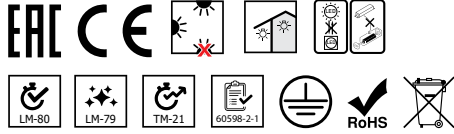

Code No Ürün Kodu	Type Tip	Power Güç (W)	Luminous Flux Işık Akısı (lm)	Colour Temp. Renk Sıcaklığı (K)	Efficacy Etkinlik Faktörü (lm/W)	Dimensions Boyutlar (mm) axbxc	Pcs / Pack Koli Adedi	Package Vol. Koli Hacmi (m ³)	Package Weight Koli Ağırlığı (kg)
110684	90°	100	15000	6500	150	1300x240x75	1	0,24	7,3
110685	90°	150	21750	6500	145	1300x240x75	1	0,24	7,3
110686	90°	200	28400	6500	142	1300x240x75	1	0,24	7,3

Product codes can change by the kelvins, dimensions, or options. Please get in contact with the sales team.
 Technical values has tolerance +/-%7 by the operating conditions.
 Ürün kodları kelvin, boyut ve opsiyonlar için değişebilir. Lütfen satış ekibi ile iletişime geçiniz.
 Teknik sonuçlar çalışma koşullarına bağlı olarak +/-%7 toleransa sahiptir.

Mechanical Specifications Mekanik Özellikler

Body	Gövde	Metal
IP Rating	IP Sınıfı	IP20
IK Rating	IK Gövde Sınıfı	IK10
Fire Protection	Alev Koruması	650°C
Cable Gland	Kablo Rakor	-
Cable	Kablo	-
RAL Code	Ral Kodu	9016
Mounting Type	Montaj Tipi	Pendant / Surface Mounted
		Sarkıt / Sıva Üstü

Optical Specifications Optik Özellikler

Light Source	Işık Kaynağı	Mid Power
Reflector	Reflektör	-
Lens		PMMA
Diffuser	Difüzör	-
CRI		>80
Colour Temperature	Renk Sıcaklığı	3000K / 4000K / 6500K
Photobiological Risk Group	Fotobiyolojik Risk Grubu	RG1
Beam Angle	Işık Açısı	30°/60°/90°/Asymmetric

Electrical Specifications Elektriksel Özellikler

Input Voltage	Giriş Gerilimi	220-240Vac
Frequency	Frekans	50-60Hz
Class	Sınıf	I
System Lifetime	Sistem Ömrü	>50.000h
Power Factor	Güç Faktörü	>0,95
Operating Temperature	Çalışma Sıcaklığı	-20°C / 45°C
Standards	Standartlar	60598-2-1, LM79, EN 13032, LM80, EN 62262, EN 60529

Options Opsiyonlar

DALI		✓
1-10V		✓
Step DIM		-
1hour Emergency Kit	1 Saat Acil Kit	✓
3hour Emergency Kit	3 Saat Acil Kit	✓
Electrical Protection	Elektriksel Sınıf	-
Microwave Sensor	Radar Sensör	-



Technical Drawing

Teknik Çizim

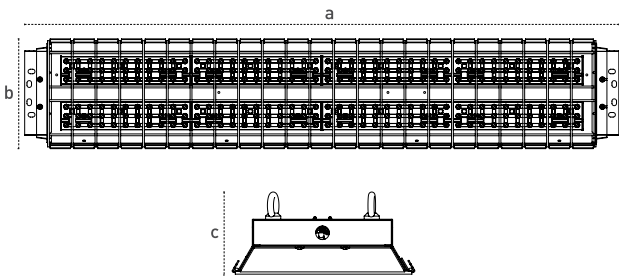

Mounting Options

Montaj Opsiyonları

Pendant With Chain Zincirleme Sarkıt

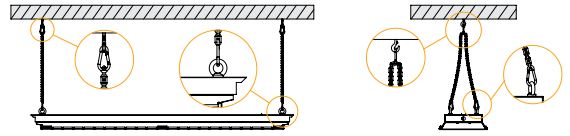

Angle Adjustable Mounting

Açı Ayarlı Montaj

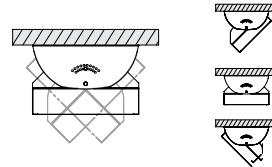

Surface Mounting

Sıva Üstü Montaj



Light Distribution Curve

Işık Şiddeti Dağılım Eğrisi

30°

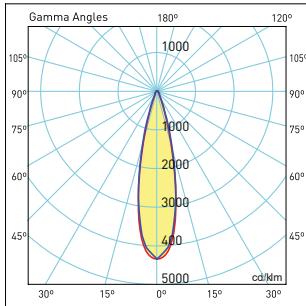

60°

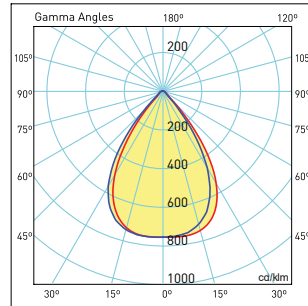

90°

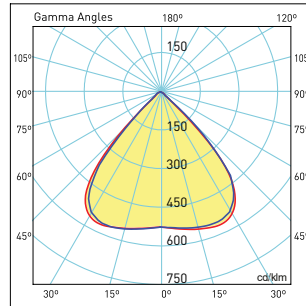

Asimetrik

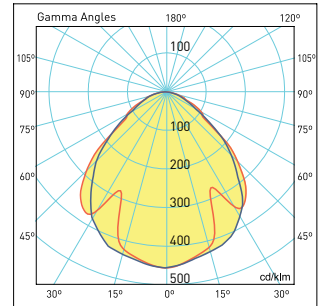

Visit our website for latest product informations and documents.
Güncel ürün bilgi ve belgeleri için web sitemizi ziyaret ediniz.



Pelsan



All your lighting needs in one address.
Tüm aydınlatma ihtiyaçlarınız için tek adres.

www.pelsan.com.tr
info@pelsan.com.tr | export@pelsan.com.tr

**HEAD OFFICE
GENEL MERKEZ**

Çerkeşli O.S.B.
İmes 5. Cadde No:12
Dilovası / Kocaeli - TÜRKİYE



/PelsanAydınlatma



pelsan-aydinlatma



pelsan aydinlatma



/pelsanaydinlatma



/PelsanLight

T : +9(0850) 460 75 76

F : +9(0216) 364 60 15