



EX-PROOF LUMINAIRES

2024

www.pelsan.com.tr



Since
1982



More than
3500 SKU



500
Employees



5 million luminaire
production capacity per year



Factory

● Electronic Assembly Line

● Plastic Injection Moulding Area

● Semi-finished Goods Process Area

● Moulding Area

● Diffuser Treatment Area

● Landscape Lighting Fixture Parts
Manufacturing Area

● Glass Reinforced
Polyester (GRP) Product
Manufacturing Area

● Powder Coating &
Painting Area

● Assembly Line

● Office



30000 ^{m²} **Manufacturing Zone**

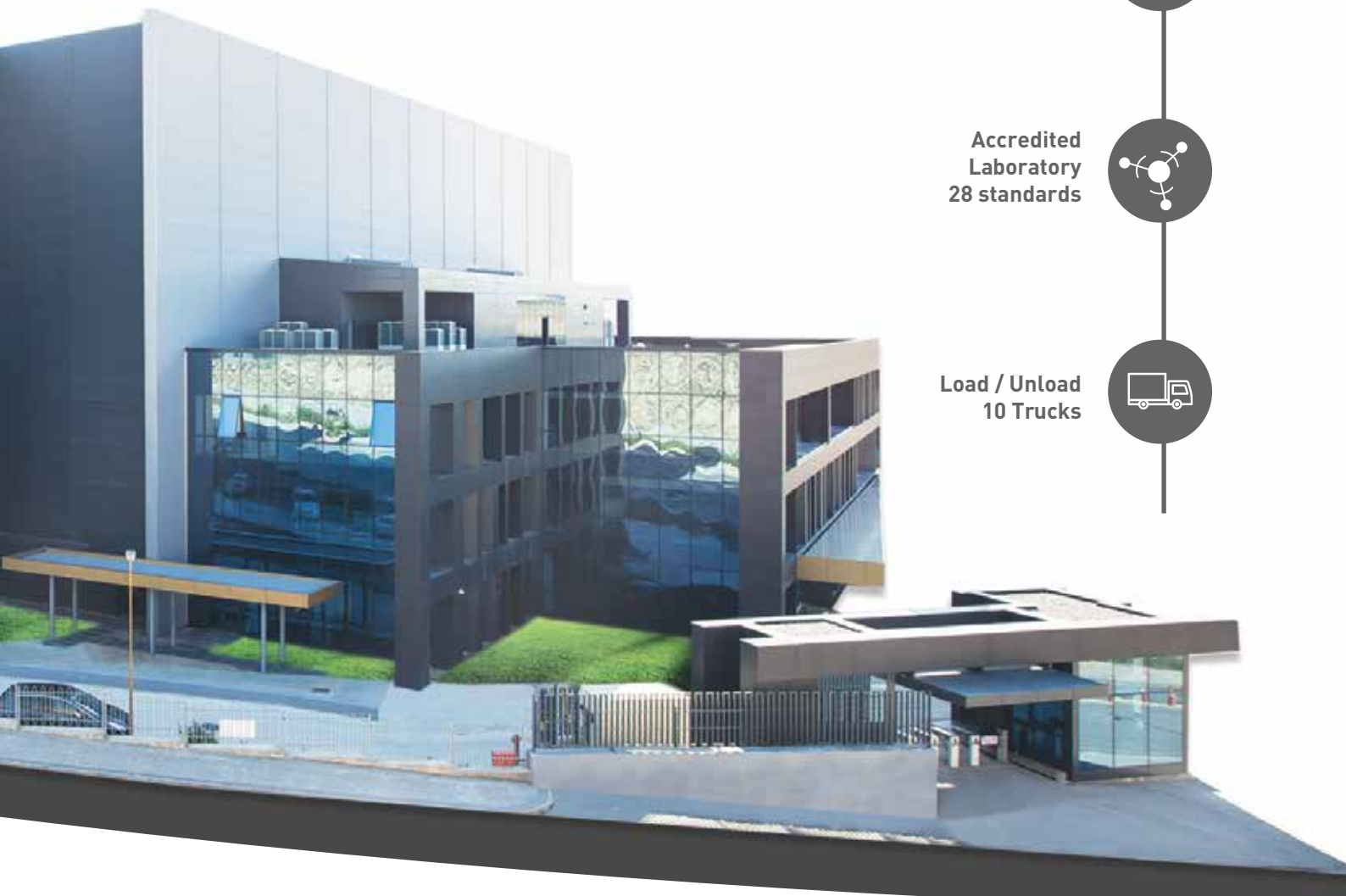

R&D Center
15 Engineers



Accredited Laboratory
28 standards



Load / Unload
10 Trucks



Type Tip	Power Güç	Lumen Package Lümen Paketi	Efficacy Etkinlik Faktörü	IP Rating Sınıfı	Zone Class Sınıfı	Protection Koruma	Options Opsiyonlar
 Largo LED Waterproof / Etanj	10W - 45W	1650lm- 54950lm	110lm/W	IP65	Zone2 Zone22	II 3G Ex ec IIC T6 Gc II 3D Ex tc IIIC (T80°C) Dc	Emergency Unit
 Largo LED Tube Waterproof / Etanj	Single/ Double	-	-	IP65	Zone2 Zone22	II 3G Ex ec IIC T6 Gc II 3D Ex tc IIIC (T80°C) Dc	-
 Largo T8 Waterproof / Etanj	2x18W/ 2X36W	-	-	IP65	Zone2 Zone22	II 3G Ex ec IIC T6 Gc II 3D Ex tc IIIC (T80°C) Dc	-
 Ausled Emergency / Acil Aydınlatma	5W / 15W	500lm- 1500lm	110lm/W	IP65	Zone2 Zone22	II 3G Ex ec IIC T6 Gc II 3D Ex tc IIIC (T85°C) Dc	Exit Stickers Surface / Recessed Mounted
 Elit Lirad Floodlight / Projektör	20W - 50W	2800lm- 7000lm	Up to 140lm/W	IP65	Zone2 Zone22	II 3G Ex ec IIC T5 Gc II 3D Ex tc IIIC (T95°C) Dc	30°/60°/90° Asymmetric Lens
 Nairo Floodlight / Projektör	50W - 200W	8250lm- 28600lm	Up to 165lm/W	IP66	Zone2 Zone22	II 3G Ex ec IIC T5 Gc II 3D Ex tc IIIC (T95°C) Dc	30°/60°/90° Asymmetric Lens
 Nairo Road & Street / Yol & Cadde	50W - 200W	8250lm- 28600lm	Up to 165lm/W	IP66	Zone2 Zone22	II 3G Ex ec IIC T5 Gc II 3D Ex tc IIIC (T95°C) Dc	30°/60°/90° Asymmetric Lens
 Piriliz Canopy / Kanopi	50W - 200W	8250lm- 28600lm	Up to 165lm/W	IP66	Zone2 Zone22	II 3G Ex ec IIC T5 Gc II 3D Ex tc IIIC (T95°C) Dc	30°/60°/90° Asymmetric Lens
 Sia Highbay / Yüksek Tavan	50W - 200W	8250lm- 28600lm	Up to 165lm/W	IP66	Zone2 Zone22	II 3G Ex ec IIC T5 Gc II 3D Ex tc IIIC (T95°C) Dc	30°/60°/90° Asymmetric Lens

Type Tip	Power Güç	Lumen Package Lümen Paketi	Efficacy Etkinlik Faktörü	IP Rating Sınıfı	Zone Class Sınıfı	Protection Koruma	Options Opsiyonlar
 <p>Atarex Highbay / Yüksek Tavan</p>	50W-240W	6000lm-29520lm	120lm/W-132lm/W	IP66	Zone1 Zone21	II 2G Ex db IIB T4 Gb II 2D Ex tb IIIC T130°C Db	DALI, Emergency Unit, 30° / 60° / 90° Lens, RAL Code
 <p>Atarex Floodlight / Projektör</p>	50W-480W	6000lm-50400lm	105lm/W - 132lm/W	IP66	Zone1 Zone21	II 2G Ex db IIB T4 Gb II 2D Ex tb IIIC T130°C Db	DALI, Emergency Unit, 30° / 60° / 90° Lens, RAL Code
 <p>Exta Waterproof / Etanj</p>	50W-150W	6800lm-19800lm	132lm/W-137lm/W	IP66	Zone1 Zone21	II 2G Ex db IIB T6 Gb II 2D Ex tb IIIC T85°C Db	DALI, Emergency Unit, Radar Sensor
 <p>Exta Emergency / Acil Aydınlatma</p>	8W	480lm	60lm/W	IP66	Zone1 Zone21	II 2G Ex db IIB T6 Gb II 2D Ex tb IIIC T85°C Db	-



ATEX - Ex-Proof Atarex Highbay Luminaires



ATEX - Ex-Proof Atarex Floodlight Luminaires



ATEX - Ex-Proof Exta Series Luminaires



ATEX Documents Belgeleri



ATEX - Ex-Proof Largo Waterproof Luminaires



ATEX - Ex-Proof Elit Lirad Luminaires



ATEX - Ex-Proof Ausled-Rausled Luminaires



ATEX - Ex-Proof Sia-Nairo-Piriliz Luminaires

Pelsan Ex-Proof Luminaires can be used safely in

Chemical, paint and coating facilities,
petroleum storage facilities, oil filling and
discharging facilities, ports and shipyards,
power plant & industrial plants,
fueling stations

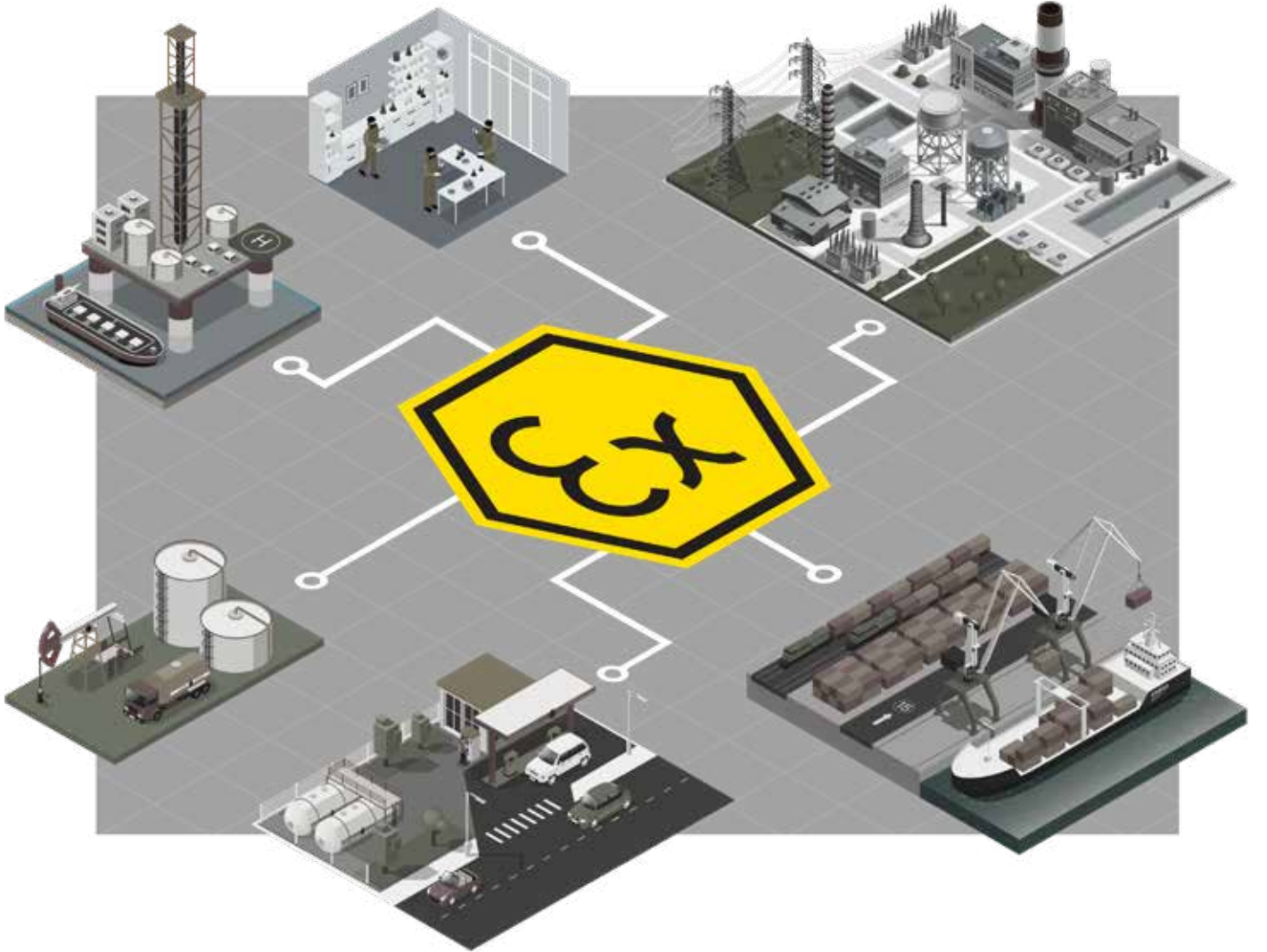

Pelsan Ex-Proof Armatürleri

Kimya ve boya tesisleri, petrol depolama tesisleri,
petrol dolum boşaltım tesisleri, liman & tersaneler,
enerji santralleri, endüstriyel tesisler ve
akaryakıt İstasyonlarında

**güvenle
kullanabilirsiniz!**



Ex-Proof Highbay Ex-Proof Yüksek Tavan Atarex



Wide power option: 50W-240W

Gas explosion proof: ZONE 1

Dust explosion proof: ZONE21

II 2G Ex db IIB T4 Gb

II 2D Ex tb IIIC T130°C Db ATEX directive

Geniş güç opsiyonu: 50W-240W

Gaz patlama koruması: ZONE 1

Toz patlama koruması: ZONE21

II 2G Ex db IIB T4 Gb

II 2D Ex tb IIIC T130°C Db ATEX direktifine uygundur.

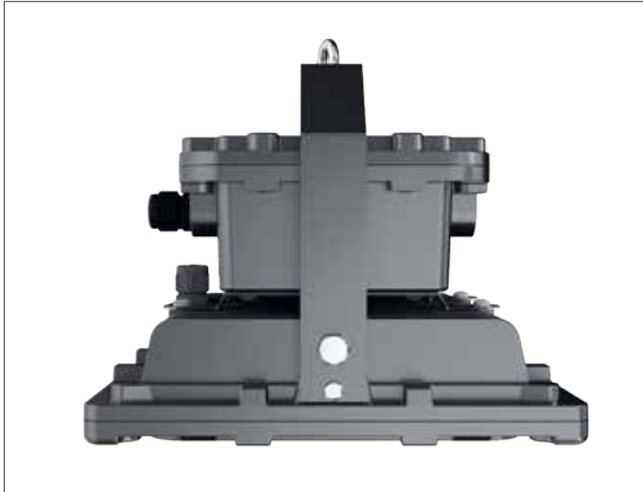
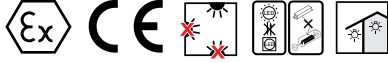

Mechanical Specifications

Mekanik Özellikler

Body	Gövde	Aluminium	Alüminyum
IP Rating	IP Sınıfı	IP66	
IK Rating Body	IK Gövde Sınıfı	IK09	
Fire Protection	Alev Koruması	650°C	
Cable Gland	Kablo Rakor	M20	
Cable	Kablo	3x1,5mm ²	
RAL Code	Ral Kodu	7043	
Mounting Type	Montaj Tipi	Surface Mounted	Sıva Üstü

Optical Specifications

Optik Özellikler

Light Source	Işık Kaynağı	Power LED	
Reflector	Reflektör	-	
Lens	Lens	PMMA	
Diffuser	Difüzör	Clear Glass	Şeffaf Cam (10mm)
CRI		>70	
Colour Temperature	Renk Sıcaklığı	3000K / 4000K / 6500K	
Photobiological Risk Group	Fotobiyolojik Risk Grubu	RG1	
Beam Angle	Işık Açısı	30° / 60° / 90°	

Electrical Specifications

Elektriksel Özellikler

Input Voltage	Giriş Gerilimi	220-240Vac	
Frequency	Frekans	50-60Hz	
Class	Sınıf	I	
System Lifetime	Sistem Ömrü	>50.000h	
Power Factor	Güç Faktörü	>0,95	
Operating Temperature	Çalışma Sıcaklığı	-20°C / +55°C	
Standards	Standartlar	60598-2-1, EN62262, EN60529	

Options

Opsiyonlar

DALI		✓	
1-10V		✓	
Step DIM		-	
1hour Emergency Kit	1 Saat Acil Kit	✓	
3hour Emergency Kit	3 Saat Acil Kit	✓	
Electrical Protection	Elektriksel Sınıf	-	
Microwave Sensor	Radar Sensör	-	
RAL Code	RAL Kodu	✓	
Marine Painting	Marin Boya	-	

Code No Ürün Kodu	Power Güç (W)	Luminous Flux Işık Akısı (lm)	Colour Temp. Renk Sıcaklığı (K)	Efficacy Etkinlik Faktörü (lm/W)	Dimensions Boyutlar (mm) axbxc	Pcs / Pack Koli Adedi	Package Vol. Koli Hacmi (m ³)	Package Weight Koli Ağırlığı (kg)
115866	50	6000	6500	120	342x307x241	1	0,032	15,3
115867	100	13200	6500	132	342x307x241	1	0,032	15,3
115868	150	19350	6500	129	342x307x241	1	0,032	15,3
115869	200	25000	6500	125	342x307x241	1	0,032	15,3
115870	240	29520	6500	123	342x307x241	1	0,032	15,3

Product codes can change by the kelvins, dimensions, or options. Please get in contact with the sales team.

Technical values have tolerance +/-%7 by the operating conditions.

Ürün kodları kelvin, boyut ve opsiyonlar için değişebilir. Lütfen satış ekibi ile iletişime geçiniz.

Teknik sonuçlar çalışma koşullarına bağlı olarak +/-%7 toleransa sahiptir.



Technical Drawing

Teknik Çizim

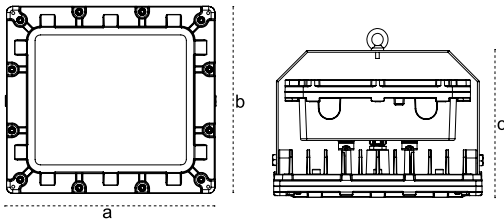

Light Distribution Curve

Işık Şiddeti Dağılım Eğrisi

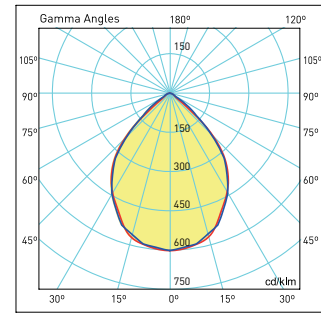

180.0 — 0.0 200W η : 1000.0%

270.0 — 90.0

Cone Diagram

Konik Diagram

1m	8012lx-15942lx	178,24cm
2m	2003lx-3986lx	356,48cm
3m	890,3lx-1771lx	534,71cm
4m	500,8lx-996,4lx	712,95cm
5m	320,5lx-637,7lx	891,19cm
6m	222,6lx-442,8lx	1069,43cm
7m	163,5lx-325,4lx	1247,67cm
8m	125,2lx-249,1lx	1425,90cm
9m	98,92lx-196,8lx	1604,14cm
10m	80,12lx-159,4lx	1782,38cm

Height Eavg; Emax Angle: 83,41° Diameter

Visit our website for latest product informations and documents.
Güncel ürün bilgi ve belgeleri için web sitemizi ziyaret ediniz.



Ex-Proof Floodlights Ex-Proof Projektörler Atarex



Wide power option: 50W-480W

Gas explosion proof: ZONE 1

Dust explosion proof: ZONE21

II 2G Ex db IIB T4 Gb

II 2D Ex tb IIIC T130°C Db ATEX directive

Geniş güç opsiyonu: 50W-480W

Gaz patlama koruması: ZONE 1

Toz patlama koruması: ZONE21

II 2G Ex db IIB T4 Gb

II 2D Ex tb IIIC T130°C Db ATEX direktifine uygun.

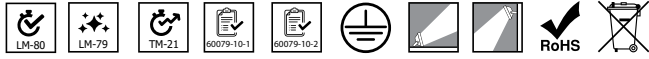

Mechanical Specifications

Mekanik Özellikler

Body	Gövde	Aluminium	Alüminyum
IP Rating	IP Sınıfı	IP66	
IK Rating	IK Gövde Sınıfı	IK09	
Fire Protection	Alev Koruması	650°C	
Cable Gland	Kablo Rakor	M20	
Cable	Kablo	3x1,5mm ²	
RAL Code	Ral Kodu	7043	
Mounting Type	Montaj Tipi	Pole / Ground	Direk / Zemin

Optical Specifications

Optik Özellikler

Light Source	Işık Kaynağı	Power LED	
Reflector	Reflektör	-	
Lens	Lens	PMMA	
Diffuser	Difüzör	Clear Glass	Şeffaf Cam (10mm)
CRI		>70	
Colour Temperature	Renk Sıcaklığı	3000K / 4000K / 6500K	
Photobiological Risk Group	Fotobiyolojik Risk Grubu	RG1	
Beam Angle	Işık Açısı	30° / 60° / 90°	

Electrical Specifications

Elektriksel Özellikler

Input Voltage	Giriş Gerilimi	220-240Vac	
Frequency	Frekans	50-60Hz	
Class	Sınıf	I	
System Lifetime	Sistem Ömrü	>50.000h	
Power Factor	Güç Faktörü	>0,95	
Operating Temperature	Çalışma Sıcaklığı	-20°C / +55°C	
Standards	Standartlar	EN60598-2-5, EN62262, EN60529,	

Options

Opsiyonlar

DALI		✓	
1-10V		✓	
Step DIM		-	
1hour Emergency Kit	1 Saat Acil Kit	✓	
3hour Emergency Kit	3 Saat Acil Kit	✓	
Electrical Protection	Elektriksel Sınıf	-	
Microwave Sensor	Radar Sensör	-	
RAL Code	RAL Kodu	✓	
Marine Painting	Marin Boya	-	

Code No Ürün Kodu	Power Güç (W)	Luminous Flux Işık Akısı (lm)	Colour Temp. Renk Sıcaklığı (K)	Efficacy Etkinlik Faktörü (lm/W)	Dimensions Boyutlar (mm) axbxc	Pcs / Pack Koli Adedi	Package Vol. Koli Hacmi (m ³)	Package Weight Koli Ağırlığı (kg)
115486	50	6000	6500	120	342x350x264	1	0,04	15,5
115865	100	13200	6500	132	342x350x264	1	0,04	15,5
115864	150	19350	6500	129	342x350x264	1	0,04	15,5
115863	200	25000	6500	125	342x350x264	1	0,04	15,5
115487	240	29520	6500	123	342x350x264	1	0,04	15,5
115780	480	50400	6500	105	438x754x488	1	0,11	24,9

Product codes can change by the kelvins, dimensions, or options. Please get in contact with the sales team.

Technical values have tolerance +/-%7 by the operating conditions.

Ürün kodları kelvin, boyut ve opsiyonlar için değişebilir. Lütfen satış ekibi ile iletişime geçiniz.

Teknik sonuçlar çalışma koşullarına bağlı olarak +/-%7 toleransa sahiptir.



Technical Drawing

Teknik Çizim

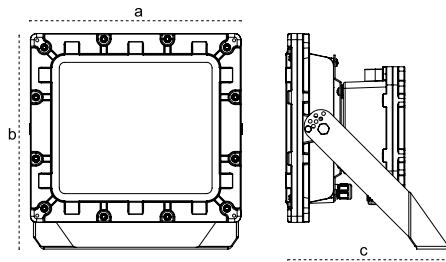

Light Distribution Curve

Işık Şiddeti Dağılım Eğrisi

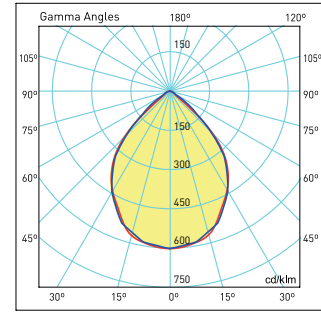

180.0 — 0.0 200W η : 1000.0%

270.0 — 90.0

Cone Diagram

Konik Diagram

1m	8012lx-15942lx	178,24cm
2m	2003lx-3986lx	356,48cm
3m	890,3lx-1771lx	534,71cm
4m	500,8lx-996,4lx	712,95cm
5m	320,5lx-637,7lx	891,19cm
6m	222,6lx-442,8lx	1069,43cm
7m	163,5lx-325,4lx	1247,67cm
8m	125,2lx-249,1lx	1425,90cm
9m	98,92lx-196,8lx	1604,14cm
10m	80,12lx-159,4lx	1782,38cm

Height Eavg; Emax Angle: 83,41° Diameter

Visit our website for latest product informations and documents.
Güncel ürün bilgi ve belgeleri için web sitemizi ziyaret ediniz.



Ex-Proof Waterproof Luminaires Ex-Proof Etanj Armatürleri

Exta



Wide power range: 50W-150W
Up to 137lm/W efficiency
Gas explosion proof: ZONE1
Dust explosion proof: ZONE21
II 2G Ex db IIB T6 Gb
II 2D Ex tb IIIC T85°C Db ATEX directive

Geniş güç aralığı: 50W-150W
137lm/W'a varan etkinlik faktörü
Gaz patlama koruması: ZONE1
Toz patlama koruması: ZONE21
II 2G Ex db IIB T6 Gb
II 2D Ex tb IIIC T85°C Db ATEX direktifine uygundur.

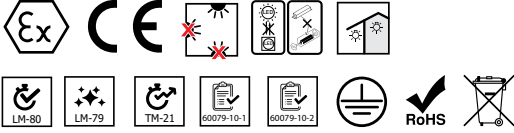

Mechanical Specifications Mekanik Özellikler

Body Gövde	Aluminium Alüminyum
IP Rating IP Sınıfı	IP66
IK Rating Body IK Gövde Sınıfı	IK10
Fire Protection Alev Koruması	650°C
Cable Gland Kablo Rakor	M20
Cable Kablo	3x1,5mm ²
RAL Code Ral Kodu	7043
Mounting Type Montaj Tipi	Surface Mounted / Pendant Sıva Üstü / Sarkıt

Optical Specifications Optik Özellikler

Light Source Işık Kaynağı	Mid Power LED
Reflector Reflektör	-
Lens Lens	-
Diffuser Difüzör	PC
CRI	>70
Colour Temperature Renk Sıcaklığı	3000K / 4000K / 6500K
Photobiological Risk Group Fotobiyolojik Risk Grubu	RG1
Beam Angle Işık Açısı	120°

Electrical Specifications Elektriksel Özellikler

Input Voltage Giriş Gerilimi	220-240Vac
Frequency Frekans	50-60Hz
Class Sınıf	I
System Lifetime Sistem Ömrü	>50.000h
Power Factor Güç Faktörü	>0,95
Operating Temperature Çalışma Sıcaklığı	-20°C / +55°C
Standards Standartlar	EN60598-2-1, EN62262, EN60529, EN13032, LM79, LM80, 60079-10-1, 60079-10-2

Options Opsiyonlar

DALI	✓
1-10V	✓
Step DIM	✓
1hour Emergency Kit 1 Saat Acil Kit	✓
3hour Emergency Kit 3 Saat Acil Kit	✓
Electrical Protection Elektriksel Sınıf	-
Microwave Sensor Radar Sensör	✓

Code No Ürün Kodu	Power Güç (W)	Luminous Flux Işık Akısı (lm)	Colour Temp. Renk Sıcaklığı (K)	Efficacy Etkinlik Faktörü (lm/W)	Dimensions Boyutlar (mm) axbxc	Pcs / Pack Koli Adedi	Package Vol. Koli Hacmi (m ³)	Package Weight Koli Ağırlığı (kg)
115873	50	6800	6500	136	1270x182x168	1	0,045	10,5
115874	75	9900	6500	132	1270x182x168	1	0,045	10,5
115875	100	13700	6500	137	1552x182x168	1	0,05	13
115489	150	19800	6500	132	1552x182x168	1	0,05	13

Product codes can change by the kelvins, dimensions, or options. Please get in contact with the sales team.
Technical values have tolerance +/-7% by the operating conditions.
Ürün kodları kelvin, boyut ve opsiyonlar için değişebilir. Lütfen satış ekibi ile iletişime geçiniz.
Teknik sonuçlar çalışma koşullarına bağlı olarak +/-7% toleransa sahiptir.

Ex-Proof Emergency Luminaires

Ex-Proof Acil Aydınlatma Armatürleri

Exta



ZONE 1
ZONE21



Mechanical Specifications

Mekanik Özellikler

Body Gövde	Aluminium Alüminyum
IP Rating IP Sınıfı	IP66
IK Rating Body IK Gövde Sınıfı	IK10
Fire Protection Alev Koruması	650°C
Cable Gland Kablo Rakor	M20
Cable Kablo	3x1,5mm ²
RAL Code Ral Kodu	7043
Mounting Type Montaj Tipi	Surface Mounted, Pendant Sıva Üstü, Sarkıt

Optical Specifications

Optik Özellikler

Light Source Işık Kaynağı	Mid Power LED
Reflector Reflektör	-
Lens Lens	-
Diffuser Difüzör	PC
CRI	>70
Colour Temperature Renk Sıcaklığı	3000K / 4000K / 6500K
Photobiological Risk Group Fotobiyolojik Risk Grubu	RG1
Beam Angle Işık Açısı	120°

Electrical Specifications

Elektriksel Özellikler

Input Voltage Giriş Gerilimi	220-240Vac
Frequency Frekans	50-60Hz
Class Sınıf	I
System Lifetime Sistem Ömrü	>50.000h
Power Factor Güç Faktörü	>0,95
Operating Temperature Çalışma Sıcaklığı	-20°C / +45°C
Function Mode Çalışma Şekli	Maintained/Non-Maintained Sürekli/Kesintide
Charging Indicator Şarj Göstergesi	-
Discharging Indicator Deşarj Göstergesi	-
Switch Anahtar	-
Standards Standartlar	EN60598-2-1, EN62262, EN60529, EN13032, LM79, LM80, 60079-10-1, 60079-10-2

Options

Opsiyonlar

DALI	-
1-10V	-
Step DIM	-
Electrical Protection Elektriksel Sınıf	-
RAL Code RAL Kodu	-

Gas explosion proof: ZONE1
Dust explosion proof: ZONE21
II 2G Ex db IIB T6 Gb
II 2D Ex tb IIIC T85°C Db ATEX directive

Gaz patlama koruması: ZONE,1
Toz patlama koruması: ZONE21
II 2G Ex db IIB T6 Gb
II 2D Ex tb IIIC T85°C Db ATEX direktifine uygun

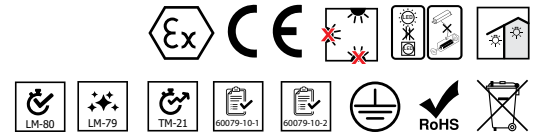

Code No Ürün Kodu	Power Güç (W)	Battery Batarya	Charging Time Şarj Süresi	Discharging Time Deşarj Süresi	Luminous Flux Işık Akısı (lm)	Colour Temp. Renk Sıcaklığı (K)	Efficacy Etkinlik Faktörü (lm/W)	Dimensions Boyutlar (mm) axbxc	Pcs / Pack Koli Adedi	Pack. Vol. Koli Hacmi (m ³)	Pack. Weight Koli Ağırlığı (kg)
115488	8	3,7V 4500mAh	24h.	3h.	480	6500	60	182x465x168	1	0,01	-

Product codes can change by the kelvins, dimensions, or options. Please get in contact with the sales team.
Technical values have tolerance +/-%7 by the operating conditions.
Ürün kodları kelvin, boyut ve opsiyonlar için değişebilir. Lütfen satış ekibi ile iletişime geçiniz.
Teknik sonuçlar çalışma koşullarına bağlı olarak +/-%7 toleransa sahiptir.

Ex-Proof Waterproof Ex-Proof Etanj Largo LED



Gas explosion proof: ZONE 2
Dust explosion proof: ZONE22
II 3G Ex ec IIC T6 Gc
II 3D Ex tc IIIC (T80 °C) Dc
Complies with 2014/34/EU ATEX Directive

Gaz patlama koruması: ZONE 2
Toz patlama koruması: ZONE22
II 3G Ex ec IIC T6 Gc
II 3D Ex tc IIIC (T80 °C) Dc
2014/34/EU ATEX direktifine uygun



Mechanical Specifications

Mekanik Özellikler

Body	Gövde	GRP
IP Rating	IP Sınıfı	IP65
IK Rating	IK Gövde Sınıfı	IK08
Fire Protection	Alev Koruması	650°C
Cable Gland	Kablo Rakor	PG11
Cable	Kablo	-
RAL Code	Ral Kodu	1023
Mounting Type	Montaj Tipi	Surface Mounted Sıva Üstü

Optical Specifications

Optik Özellikler

Light Source	Işık Kaynağı	Power LED
Reflector	Reflektör	-
Lens	Lens	-
Diffuser	Difüzör	PC
CRI		>80
Colour Temperature	Renk Sıcaklığı	3000K / 4000K / 6500K
Photobiological Risk Group	Fotobiyolojik Risk Grubu	RG1
Beam Angle	Işık Açısı	120°

Electrical Specifications

Elektriksel Özellikler

Input Voltage	Giriş Gerilimi	220-240Vac
Frequency	Frekans	50-60Hz
Class	Sınıf	I
System Lifetime	Sistem Ömrü	>50.000h
Power Factor	Güç Faktörü	>0,95
Operating Temperature	Çalışma Sıcaklığı	-20°C / 50°C
Standards	Standartlar	EN60598-2-1, EN62262, EN60529, EN13032, LM79, LM80, 60079-10-1, 60079-10-2

Options

DALI		-
1-10V		-
Step DIM		-
1hour Emergency Kit	1 Saat Acil Kit	✓
3hour Emergency Kit	3 Saat Acil Kit	✓
Electrical Protection	Elektriksel Sınıf	-
Microwave Sensor	Radar Sensör	-
RAL Code	RAL Kodu	✓
Marine Painting	Marin Boya	-

Code No Ürün Kodu	Power Güç (W)	Luminous Flux Işık Akısı (lm)	Colour Temp. Renk Sıcaklığı (K)	Efficacy Etkinlik Faktörü (lm/W)	Dimensions Boyutlar (mm) axbxc	Pcs / Pack Koli Adedi	Package Vol. Koli Hacmi (m³)	Package Weight Koli Ağırlığı (kg)
108458	25	2750	6500	110	670x85x125	6	0,053	12,8
108459	45	4950	6500	110	1280x85x125	6	0,1	18,5

Product codes can change by the kelvins, dimensions, or options. Please get in contact with the sales team.
Technical values have tolerance +-7% by the operating conditions.
Ürün kodları kelvin, boyut ve opsiyonlar için değişebilir. Lütfen satış ekibi ile iletişime geçiniz.
Teknik sonuçlar çalışma koşullarına bağlı olarak +-7% toleransa sahiptir.



Technical Drawing

Teknik Çizim

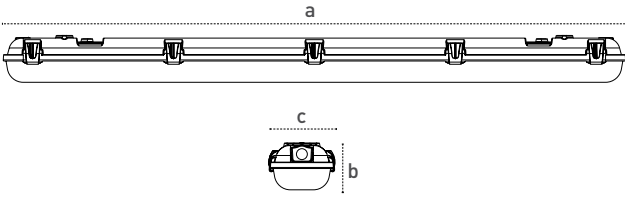

Light Distribution Curve

Işık Şiddeti Dağılım Eğrisi

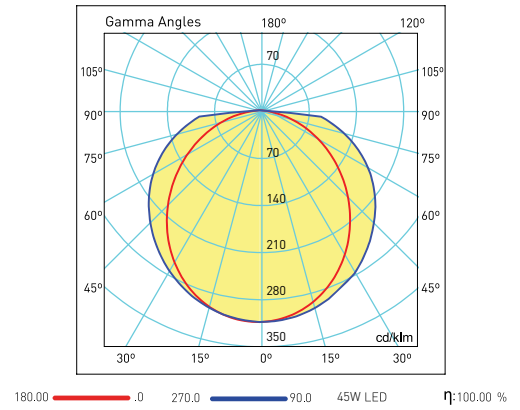

Ex-Proof Waterproof Ex-Proof Etanj Largo LED Tube



ZONE2
ZONE22



Gas explosion proof: ZONE 2
Dust explosion proof: ZONE22
II 3G Ex ec IIC T6 Gc
II 3D Ex tc IIIC (T80 °C) Dc
Complies with 2014/34/EU ATEX Directive

Gaz patlama koruması: ZONE 2
Toz patlama koruması: ZONE22
II 3G Ex ec IIC T6 Gc
II 3D Ex tc IIIC (T80 °C) Dc
2014/34/EU ATEX direktifine uygun



Mechanical Specifications

Mekanik Özellikler

Body	Gövde	GRP
IP Rating	IP Sınıfı	IP65
IK Rating Body	IK Gövde Sınıfı	IK08
Fire Protection	Alev Koruması	650°C
Cable Gland	Kablo Rakor	PG11
Cable	Kablo	-
RAL Code	Ral Kodu	1023
Mounting Type	Montaj Tipi	Surface Mounted Sıva Üstü

Optical Specifications

Optik Özellikler

Light Source	Işık Kaynağı	-
Reflector	Reflektör	-
Lens	Lens	-
Diffuser	Difüzör	PC
CRI		-
Colour Temperature	Renk Sıcaklığı	-
Photobiological Risk Group	Fotobiyolojik Risk Grubu	-
Beam Angle	Işık Açısı	120°

Electrical Specifications

Elektriksel Özellikler

Input Voltage	Giriş Gerilimi	220-240Vac
Frequency	Frekans	50-60Hz
Class	Sınıf	I
System Lifetime	Sistem Ömrü	>50.000h
Power Factor	Güç Faktörü	-
Operating Temperature	Çalışma Sıcaklığı	-20°C / 50°C
Standards	Standartlar	EN60598-2-1, EN62262, EN60529, EN13032, LM79, LM80, 60079-10-1, 60079-10-2

Options

DALI		-
1-10V		-
Step DIM		-
1hour Emergency Kit	1 Saat Acil Kit	-
3hour Emergency Kit	3 Saat Acil Kit	-
Electrical Protection	Elektriksel Sınıf	-
Microwave Sensor	Radar Sensör	-
RAL Code	RAL Kodu	✓
Marine Painting	Marin Boya	-

Code No Ürün Kodu	Power Güç (W)	Base Duy	Dimensions Boyutlar (mm) axbxc	Pcs / Pack Koli Adedi	Package Vol. Koli Hacmi (m³)	Package Weight Koli Ağırlığı (kg)
111402	1x9	1xG13	670x85x125	6	0,0414	11
111404	2x9	2xG13	670x85x125	6	0,053	12,8
111405	1x18	1xG13	1280x85x125	6	0,0774	17
111406	2x18	2xG13	1280x85x125	6	0,10062	18,5

Technical values have tolerance +/-7% by the operating conditions.
Teknik sonuçlar çalışma koşullarına bağlı olarak +/-7% toleransa sahiptir.



Technical Drawing

Teknik Çizim

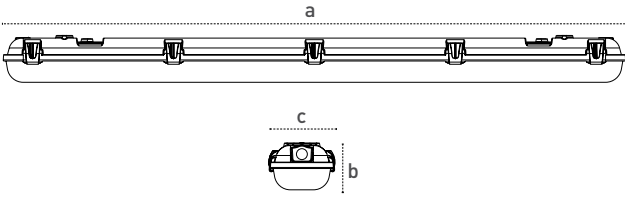

Light Distribution Curve

Işık Şiddeti Dağılım Eğrisi

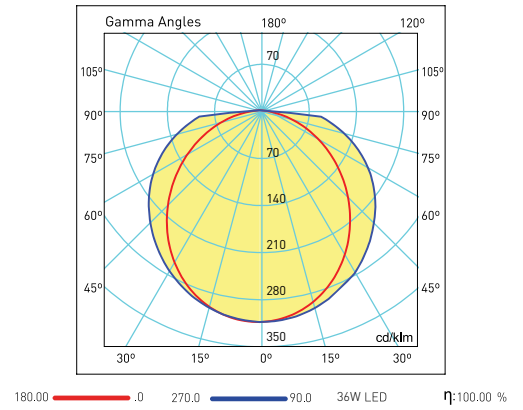

Visit our website for latest product informations and documents.
Güncel ürün bilgi ve belgeleri için web sitemizi ziyaret ediniz.



Ex-Proof Waterproof Ex-Proof Etanj Largo T8



ZONE2
ZONE22



Gas explosion proof: ZONE 2
Dust explosion proof: ZONE22
II 3G Ex ec IIC T6 Gc
II 3D Ex tc IIIC (T80 °C) Dc
Complies with 2014/34/EU ATEX Directive

Gaz patlama koruması: ZONE 2
Toz patlama koruması: ZONE22
II 3G Ex ec IIC T6 Gc
II 3D Ex tc IIIC (T80 °C) Dc
2014/34/EU ATEX direktifine uygun



Mechanical Specifications

Mekanik Özellikler

Body	Gövde	GRP
IP Rating	IP Sınıfı	IP65
IK Rating	IK Gövde Sınıfı	IK08
Fire Protection	Alev Koruması	650°C
Cable Gland	Kablo Rakor	PG11
Cable	Kablo	-
RAL Code	Ral Kodu	1023
Mounting Type	Montaj Tipi	Surface Mounted Sıva Üstü

Optical Specifications

Optik Özellikler

Light Source	Işık Kaynağı	TLD
Reflector	Reflektör	-
Lens	Lens	-
Diffuser	Difüzör	PC
CRI		-
Colour Temperature	Renk Sıcaklığı	-
Photobiological Risk Group	Fotobiyolojik Risk Grubu	-
Beam Angle	Işık Açısı	120°

Electrical Specifications

Elektriksel Özellikler

Input Voltage	Giriş Gerilimi	220-240Vac
Frequency	Frekans	50-60Hz
Class	Sınıf	I
System Lifetime	Sistem Ömrü	>50.000h
Power Factor	Güç Faktörü	>0,95
Operating Temperature	Çalışma Sıcaklığı	-20°C / 50°C
Standards	Standartlar	EN60598-2-1, EN62262, EN60529, EN13032, LM79, LM80, 60079-10-1, 60079-10-2

Options

Opsiyonlar

DALI		-
1-10V		-
Step DIM		-
1hour Emergency Kit	1 Saat Acil Kit	-
3hour Emergency Kit	3 Saat Acil Kit	-
Electrical Protection	Elektriksel Sınıf	-
Microwave Sensor	Radar Sensör	-
RAL Code	RAL Kodu	✓
Marine Painting	Marin Boya	-

Code No Ürün Kodu	Power Güç (W)	Base Duy	Dimensions Boyutlar (mm) axbxc	Pcs / Pack Koli Adedi	Package Vol. Koli Hacmi (m³)	Package Weight Koli Ağırlığı (kg)
108297	2x18	2xG13	670x85x125	6	0,05304	12,8
108298	2x36	2xG13	1280x85x125	6	0,10062	18,5

Technical values have tolerance +/-%7 by the operating conditions.
Teknik sonuçlar çalışma koşullarına bağlı olarak +/-%7 toleransa sahiptir.



Technical Drawing

Teknik Çizim

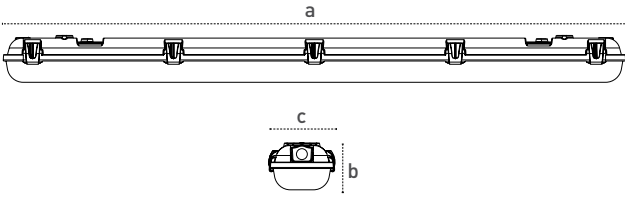

Light Distribution Curve

Işık Şiddeti Dağılım Eğrisi

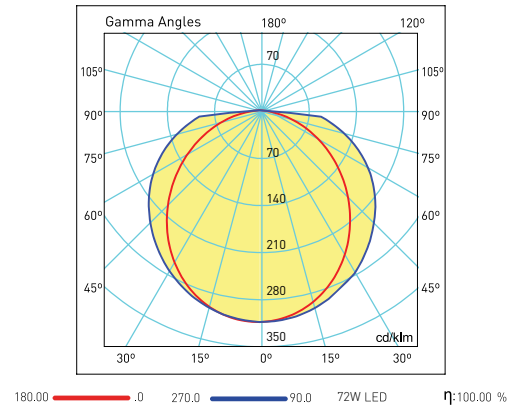

Ex-Proof Emergency Luminaires Ex-Proof Acil Aydınlatma Armatürleri Ausled & Raused



Gas Explosion Proof: ZONE 2
Dust Explosion Proof: ZONE22
II 3G Ex ec IIC T6 Gc
II 3D Ex tc IIIC (T85°C) Dc

Gaz Patlama Koruması: ZONE2
Toz Patlama Koruması: ZONE22
II 3G Ex ec IIC T6 Gc
II 3D Ex tc IIIC (T85°C) Dc

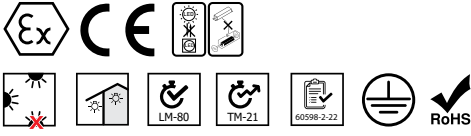

Mechanical Specifications

Mekanik Özellikler

Body	Gövde	PC
IP Rating	IP Sınıfı	IP65
IK Rating	IK Gövde Sınıfı	IK08
Fire Protection	Alev Koruması	650°C
Cable Gland	Kablo Rakor	PG9/M16
Cable	Kablo	-
RAL Code	Ral Kodu	1023
Mounting Type	Montaj Tipi	Surface-Recessed Mounted
		Sıva Üstü - Sıva Altı

Optical Specifications

Optik Özellikler

Light Source	Işık Kaynağı	Power LED
Reflector	Reflektör	-
Lens	Lens	PMMA
Diffuser	Difüzör	PC
CRI		>80
Colour Temperature	Renk Sıcaklığı	3000K-4000K-6500K
Photobiological Risk Group	Fotobiyolojik Risk Grubu	RG01
Beam Angle	Işık Açısı	110°

Electrical Specifications

Elektriksel Özellikler

Input Voltage	Giriş Gerilimi	220-240Vac
Frequency	Frekans	50-60Hz
Class	Sınıf	I
System Lifetime	Sistem Ömrü	>50.000h
Power Factor	Güç Faktörü	>0,95
Operating Temperature	Çalışma Sıcaklığı	-20°C / 45°C
Function Mode	Çalışma Şekli	Maintained / Non-Maintained
		Sürekli / Kesintide
Charging Indicator	Şarj Göstergesi	-
Discharging Indicator	Deşarj Göstergesi	-
Switch	Anahtar	-
Standards	Standartlar	60598-2-22, LM79, EN 13032, LM80, TM21, EN 62262, EN 60529, 60079-10-1, 60079-10-2
Options	Opsiyonlar	
DALI		-
1-10V		-
Step DIM		-
Electrical Protection	Elektriksel Sınıf	-
RAL Code	RAL Kodu	✓

Code No Ürün Kodu	Type Tip	Power Güç (W)	Battery Batarya	Charging Time Şarj Süresi	Discharging Time Deşarj Süresi	Lum. Flux Işık Akısı (lm)	Colour Temp. Renk Sıcaklığı (K)	Efficacy Etkinlik Faktörü (lm/W)	Dimensions Boyutlar (mm) axbxc	Pcs / Pack Koli Adedi	Pack. Vol. Koli Hacmi (m³)	Pack. Weight Koli Ağırlığı (kg)
109710	Surface Mounted Sıva Üstü	15	3,7V 4500mAh	24h	3h	1500	6500	100	350x117x76	6	0,027	5,5
111644	Recessed Mounted Sıva Altı	15	3,7V 4500mAh	24h	3h	1500	6500	100	350x117x76	6	0,027	5,5
111683	Surface Mounted Sıva Üstü	15	3,7V 4500mAh	24h	3h	1500	6500	100	350x117x218	6	0,027	5,5

Product codes can change by the kelvins, dimensions, or options. Please get in contact with the sales team. Ürün kodları kelvin, boyut ve opsiyonlar için değişebilir. Lütfen satış ekibi ile iletişime geçiniz. Technical values have tolerance +/-%7 by the operating conditions. Teknik sonuçlar çalışma koşullarına bağlı olarak +/-%7 toleransa sahiptir.

All your lighting needs in one address.
Tüm aydınlatma ihtiyaçlarınız için tek adres.



Technical Drawing

Teknik Çizim

Ausled

109710 / 111644

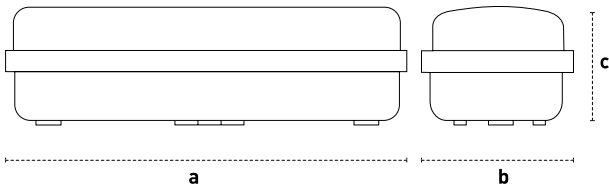

Light Distribution Curve

Işık Şiddeti Dağılım Eğrisi

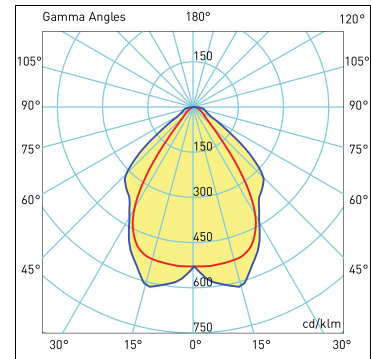

180.0 0.0 270.0 90.0 15W η :1000.0%

Technical Drawing

Teknik Çizim

Rausled

111683

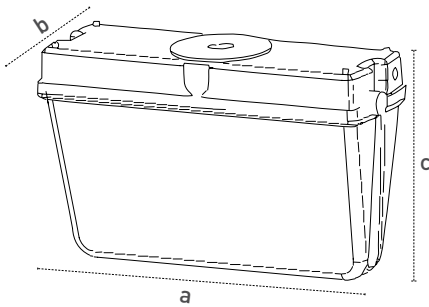

Ex-Proof Floodlights Ex-Proof Projektörler Elit Lirad



Gas Explosion Proof: ZONE 2
Dust Explosion Proof: ZONE22
II 3G Ex ec IIC T5 Gc
II 3D Ex tc IIIC (T95°C) Dc

Gaz Patlama Koruması: ZONE2
Toz Patlama Koruması: ZONE22
II 3G Ex ec IIC T5 Gc
II 3D Ex tc IIIC (T95°C) Dc



Code No Ürün Kodu	Power Güç (W)	Luminous Flux Işık Akısı (lm)	Colour Temp. Renk Sıcaklığı (K)	Efficacy Etkinlik Faktörü (lm/W)	Dimensions Boyutlar (mm) axbxc	Pcs / Pack Koli Adedi	Package Vol. Koli Hacmi (m ³)	Package Weight Koli Ağırlığı (kg)
109707	50	7000	6500	140	200x295x175	6	0,08	18

Product codes can change by the kelvins, dimensions, or options. Please get in contact with the sales team.
Technical values have tolerance +/-7% by the operating conditions.
Ürün kodları kelvin, boyut ve opsiyonlar için değişebilir. Lütfen satış ekibi ile iletişime geçiniz.
Teknik sonuçlar çalışma koşullarına bağlı olarak +/-7% toleransa sahiptir.

Mechanical Specifications Mekanik Özellikler

Body	Gövde	GRP
IP Rating	IP Sınıfı	IP65
IK Rating	IK Gövde Sınıfı	IK08
Fire Protection	Alev Koruması	650°C
Cable Gland	Kablo Rakor	M20
Cable	Kablo	3x1,5mm ²
RAL Code	Ral Kodu	1023
Mounting Type	Montaj Tipi	Pole-Ground / Direk-Zemin

Optical Specifications Optik Özellikler

Light Source	Işık Kaynağı	Power LED
Reflector	Reflektör	Aluminium Alüminyum
Lens	Lens	PMMA
Diffuser	Difüzör	Tempered Glass Temperli Cam
CRI		>70
Colour Temperature	Renk Sıcaklığı	3000K-4000K-6500K
Photobiological Risk Group	Fotobiyolojik Risk Grubu	RG01
Beam Angle	Işık Açısı	Symmetric / Asymmetric Simetrik / Asimetrik

Electrical Specifications Elektriksel Özellikler

Input Voltage	Giriş Gerilimi	220-240Vac
Frequency	Frekans	50-60Hz
Class	Sınıf	I
System Lifetime	Sistem Ömrü	>50.000h
Power Factor	Güç Faktörü	>0,95
Operating Temperature	Çalışma Sıcaklığı	-20°C / 45°C
Standards	Standartlar	60598-2-5, LM79, EN 13032, LM80, TM21, EN 62262, EN 60529, 60079-10-1, 60079-10-2

Options Opsiyonlar

DALI		-
1-10V		-
Step DIM		-
1hour Emergency Kit	1 Saat Acil Kit	-
3hour Emergency Kit	3 Saat Acil Kit	-
Electrical Protection	Elektriksel Sınıf	-
Microwave Sensor	Radar Sensör	-
RAL Code	RAL Kodu	✓
Marine Painting	Marin Boya	-



Technical Drawing

Teknik Çizim

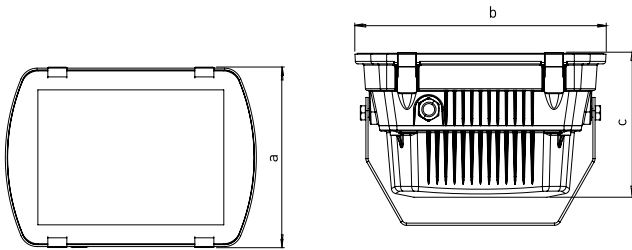

Light Distribution Curve

Işık Şiddeti Dağılım Eğrisi

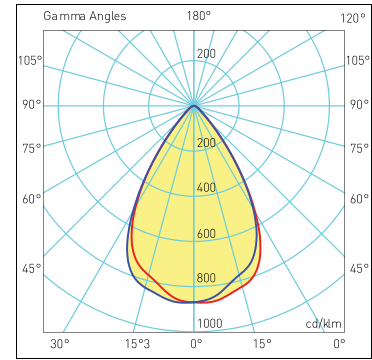

180.0 0.0 50W LED η :1000.0 %
270.0 90.0



Ex-Proof Floodlights Ex-Proof Projektörler Nairo



Gas explosion proof: ZONE 2
Dust explosion proof: ZONE22
II 3G Ex ec IIC T5 Gc
II 3D Ex tc IIIC (T95 °C) Dc
Complies with 2014/34/EU ATEX Directive

Gaz patlama koruması: ZONE 2
Toz patlama koruması: ZONE22
II 3G Ex ec IIC T5 Gc
II 3D Ex tc IIIC (T95 °C) Dc
2014/34/EU ATEX direktifine uygun

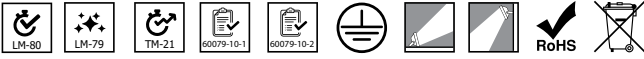

Mechanical Specifications Mekanik Özellikler

Body	Gövde	Aluminium	Alüminyum
IP Rating	IP Sınıfı	IP66	
IK Rating Body	IK Gövde Sınıfı	IK08	
Fire Protection	Alev Koruması	650°C	
Cable Gland	Kablo Rakor	PG11	
Cable	Kablo	3x1,5mm ²	
RAL Code	Ral Kodu	1023	
Mounting Type	Montaj Tipi	Pole / Ground	Direk / Zemin

Optical Specifications Optik Özellikler

Light Source	Işık Kaynağı	Power LED	
Reflector	Reflektör	-	
Lens	Lens	PMMA	
Diffuser	Difüzör	Tempered Glass	Temperli Cam
CRI		>70	
Colour Temperature	Renk Sıcaklığı	3000K / 4000K / 6500K	
Photobiological Risk Group	Fotobiyolojik Risk Grubu	RG1	
Beam Angle	Işık Açısı	30° / 60° / 90°	

Electrical Specifications Elektriksel Özellikler

Input Voltage	Giriş Gerilimi	220-240Vac	
Frequency	Frekans	50-60Hz	
Class	Sınıf	I	
System Lifetime	Sistem Ömrü	>50.000h	
Power Factor	Güç Faktörü	>0,95	
Operating Temperature	Çalışma Sıcaklığı	-20°C / +55°C	
Standards	Standartlar	EN60598-2-5, EN62262, EN60529,	

Options Opsiyonlar

DALI		-	
1-10V		-	
Step DIM		-	
1hour Emergency Kit	1 Saat Acil Kit	-	
3hour Emergency Kit	3 Saat Acil Kit	-	
Electrical Protection	Elektriksel Sınıf	-	
Microwave Sensor	Radar Sensör	-	
RAL Code	RAL Kodu	✓	
Marine Painting	Marin Boya	-	

Code No Ürün Kodu	Power Güç (W)	Luminous Flux Işık Akısı (lm)	Colour Temp. Renk Sıcaklığı (K)	Efficacy Etkinlik Faktörü (lm/W)	Dimensions Boyutlar (mm) axbxc	Pcs / Pack Koli Adedi	Package Vol. Koli Hacmi (m ³)	Package Weight Koli Ağırlığı (kg)
111372	50	8250	6500	165	342x342x121	1	0,0262	8
111371	75	12000	6500	160	342x342x121	1	0,0262	8
111370	100	15500	6500	155	342x342x121	1	0,0262	8
111369	125	19000	6500	152	342x342x121	1	0,0262	8
111368	150	22500	6500	150	342x342x121	1	0,0262	8
111055	200	28600	6500	143	342x342x121	1	0,0262	8

Product codes can change by the kelvins, dimensions, or options. Please get in contact with the sales team. Ürün kodları kelvin, boyut ve opsiyonlar için değişebilir. Lütfen satış ekibi ile iletişime geçiniz. Technical values have tolerance +-7% by the operating conditions. Teknik sonuçlar çalışma koşullarına bağlı olarak +-7% toleransa sahiptir.

All your lighting needs in one address.
Tüm aydınlatma ihtiyaçlarınız için tek adres.



Technical Drawing

Teknik Çizim

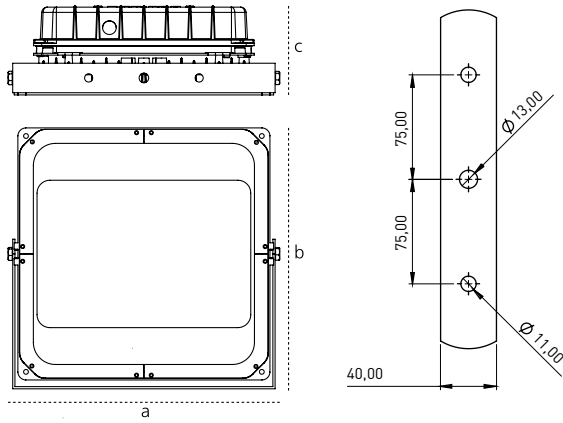

Light Distribution Curve

Işık Şiddeti Dağılım Eğrisi

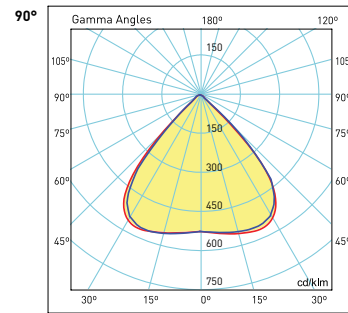
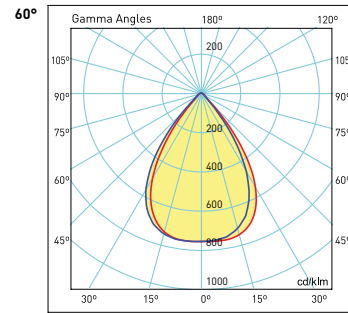
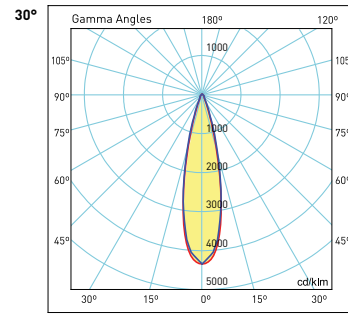

Cone Diagram

Konik Diagram

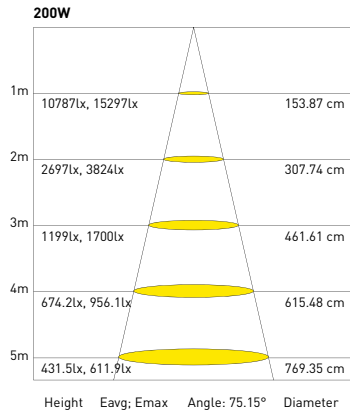

Visit our website for latest product informations and documents.
Güncel ürün bilgi ve belgeleri için web sitemizi ziyaret ediniz.



Ex-Proof Road & Street Luminaires

Ex-Proof Yol & Cadde Armatürler

Nairo



Gas explosion proof: ZONE 2

Dust explosion proof: ZONE22

II 3G Ex ec IIC T5 Gc

II 3D Ex tc IIIC (T95 °C) Dc

Complies with 2014/34/EU ATEX Directive

Gaz patlama koruması: ZONE 2

Toz patlama koruması: ZONE22

II 3G Ex ec IIC T5 Gc

II 3D Ex tc IIIC (T95 °C) Dc

2014/34/EU ATEX direktifine uygun



Mechanical Specifications

Mekanik Özellikler

Body	Gövde	Aluminium	Alüminyum
IP Rating	IP Sınıfı	IP66	
IK Rating Body	IK Gövde Sınıfı	IK08	
Fire Protection	Alev Koruması	650°C	
Cable Gland	Kablo Rakor	PG11	
Cable	Kablo	3x1,5mm ²	
RAL Code	Ral Kodu	1023	
Mounting Type	Montaj Tipi	Pole	Direk

Optical Specifications

Optik Özellikler

Light Source	Işık Kaynağı	Power LED	
Reflector	Reflektör	-	
Lens	Lens	PMMA	
Diffuser	Difüzör	Tempered Glass	Temperli Cam
CRI		>70	
Colour Temperature	Renk Sıcaklığı	3000K / 4000K / 6500K	
Photobiological Risk Group	Fotobiyolojik Risk Grubu	RG1	
Beam Angle	Işık Açısı	Asymmetric	Asimetrik

Electrical Specifications

Elektriksel Özellikler

Input Voltage	Giriş Gerilimi	220-240Vac	
Frequency	Frekans	50-60Hz	
Class	Sınıf	I	
System Lifetime	Sistem Ömrü	>50.000h	
Power Factor	Güç Faktörü	>0,95	
Operating Temperature	Çalışma Sıcaklığı	-20°C / +55°C	
Standards	Standartlar	EN60598-2-3, EN62262, EN60529, EN13032, LM79, LM80, 60079-10-1, 60079-10-2	

Options

Opsiyonlar

DALI		-	
1-10V		-	
Step DIM		-	
1hour Emergency Kit	1 Saat Acil Kit	-	
3hour Emergency Kit	3 Saat Acil Kit	-	
Electrical Protection	Elektriksel Sınıf	-	
Microwave Sensor	Radar Sensör	-	
RAL Code	RAL Kodu	✓	
Marine Painting	Marin Boya	-	

Code No Ürün Kodu	Power Güç (W)	Luminous Flux Işık Akısı (lm)	Colour Temp. Renk Sıcaklığı (K)	Efficacy Etkinlik Faktörü (lm/W)	Dimensions Boyutlar (mm) axbxc	Console Entry Konsol Girişi (mm)	Pcs / Pack Koli Adedi	Package Vol. Koli Hacmi (m ³)	Package Weight Koli Ağırlığı (kg)
111367	50	8100	4000	162	485x152x352	42-60	1	0,034	8
111366	75	11775	4000	157	485x152x352	42-60	1	0,034	8
111365	100	15200	4000	152	485x152x352	42-60	1	0,034	8
111364	125	18625	4000	149	485x152x352	42-60	1	0,034	8
111363	150	21900	4000	146	485x152x352	42-60	1	0,034	8
111362	200	28000	4000	140	485x152x352	42-60	1	0,034	8

Product codes can change by the kelvins, dimensions, or options. Please get in contact with the sales team. Ürün kodları kelvin, boyut ve opsiyonlar için değişebilir. Lütfen satış ekibi ile iletişime geçiniz. Technical values have tolerance +-7% by the operating conditions. Teknik sonuçlar çalışma koşullarına bağlı olarak +-7% toleransa sahiptir.

All your lighting needs in one address.
Tüm aydınlatma ihtiyaçlarınız için tek adres.



Technical Drawing

Teknik Çizim

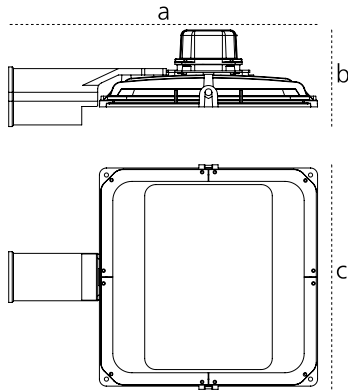

Light Distribution Curve

Işık Şiddeti Dağılım Eğrisi

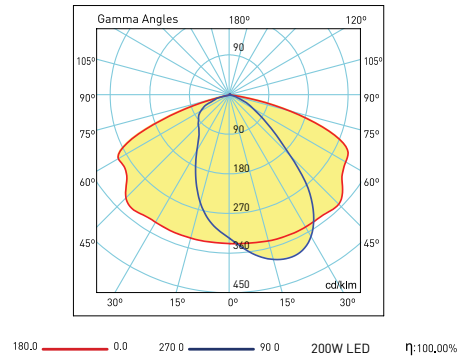

Ex-Proof Canopy Ex-Proof Kanopi Piriliz



Gas explosion proof: ZONE 2
Dust explosion proof: ZONE22
II 3G Ex ec IIC T5 Gc
II 3D Ex tc IIIC (T95 °C) Dc
Complies with 2014/34/EU ATEX Directive

Gaz patlama koruması: ZONE 2
Toz patlama koruması: ZONE22
II 3G Ex ec IIC T5 Gc
II 3D Ex tc IIIC (T95 °C) Dc
2014/34/EU ATEX direktifine uygun



Code No Ürün Kodu	Power Güç (W)	Luminous Flux Işık Akısı (lm)	Colour Temp. Renk Sıcaklığı (K)	Efficacy Etkinlik Faktörü (lm/W)	Dimensions Boyutlar (mm) axbxc	Pcs / Pack Koli Adedi	Package Vol. Koli Hacmi (m ³)	Package Weight Koli Ağırlığı (kg)
111376	50	8250	6500	165	395x385x132	1	0,0243	8
111375	75	12000	6500	160	395x385x132	1	0,0243	8
111374	100	15500	6500	155	395x385x132	1	0,0243	8
111382	125	19000	6500	152	395x385x132	1	0,0243	8
111373	150	22500	6500	150	395x385x132	1	0,0243	8
111056	200	28600	6500	143	395x385x132	1	0,0243	8

Product codes can change by the kelvins, dimensions, or options. Please get in contact with the sales team. Ürün kodları kelvin, boyut ve opsiyonlar için değişebilir. Lütfen satış ekibi ile iletişime geçiniz. Technical values have tolerance +-7% by the operating conditions. Teknik sonuçlar çalışma koşullarına bağlı olarak +-7% toleransa sahiptir.

Mechanical Specifications Mekanik Özellikler

Body	Gövde	Aluminium	Alüminyum
IP Rating	IP Sınıfı	IP66	
IK Rating	IK Gövde Sınıfı	IK08	
Fire Protection	Alev Koruması	650°C	
Cable Gland	Kablo Rakor	PG11	
Cable	Kablo	3x1,5mm ²	
RAL Code	Ral Kodu	1023	
Mounting Type	Montaj Tipi	Recessed Mounted	Sıva Altı

Optical Specifications Optik Özellikler

Light Source	Işık Kaynağı	Power LED	
Reflector	Reflektör	-	
Lens	Lens	30° / 60° / 90°	
Diffuser	Difüzör	Tempered Glass	Temperli Cam
CRI		>70	
Colour Temperature	Renk Sıcaklığı	3000K / 4000K / 6500K	
Photobiological Risk Group	Fotobiyolojik Risk Grubu	RG1	
Beam Angle	Işık Açısı	Symmetric	Simetrik

Electrical Specifications Elektriksel Özellikler

Input Voltage	Giriş Gerilimi	220-240Vac	
Frequency	Frekans	50-60Hz	
Class	Sınıf	I	
System Lifetime	Sistem Ömrü	>50.000h	
Power Factor	Güç Faktörü	>0,95	
Operating Temperature	Çalışma Sıcaklığı	-20°C / +55°C	
Standards	Standartlar	EN60598-2-2, EN62262, EN60529,	

Options Opsiyonlar

DALI		-	
1-10V		-	
Step DIM		-	
1hour Emergency Kit	1 Saat Acil Kit	-	
3hour Emergency Kit	3 Saat Acil Kit	-	
Electrical Protection	Elektriksel Sınıf	-	
Microwave Sensor	Radar Sensör	-	
RAL Code	RAL Kodu	✓	
Marine Painting	Marin Boya	-	



Technical Drawing
Teknik Çizim

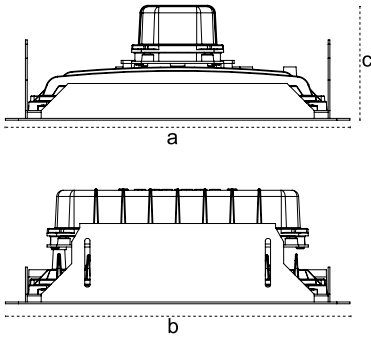

Light Distribution Curve
Işık Şiddeti Dağılım Eğrisi

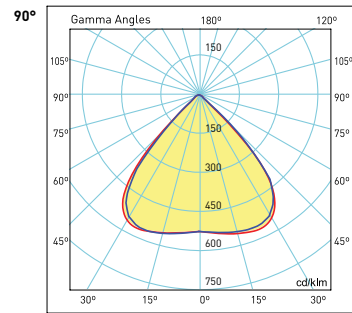
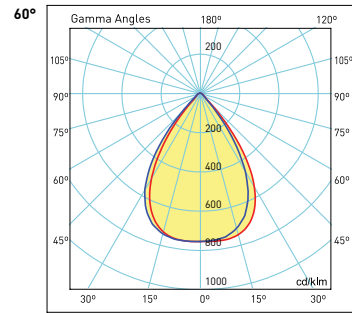
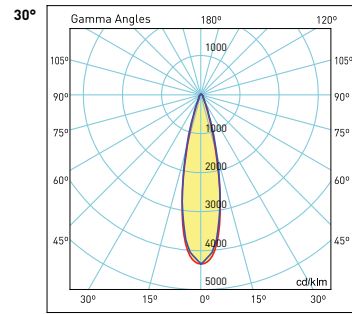

Visit our website for latest product informations and documents.
Güncel ürün bilgi ve belgeleri için web sitemizi ziyaret ediniz.



Ex-Proof Highbay Ex-Proof Yüksek Tavan Sia



Gas explosion proof: ZONE 2
Dust explosion proof: ZONE22
II 3G Ex ec IIC T5 Gc
II 3D Ex tc IIIC (T95 °C) Dc
Complies with 2014/34/EU ATEX Directive

Gaz patlama koruması: ZONE 2
Toz patlama koruması: ZONE22
II 3G Ex ec IIC T5 Gc
II 3D Ex tc IIIC (T95 °C) Dc
2014/34/EU ATEX direktifine uygun

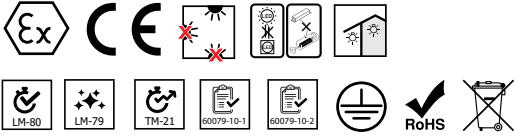

Mechanical Specifications Mekanik Özellikler

Body	Gövde	Aluminium	Alüminyum
IP Rating	IP Sınıfı	IP66	
IK Rating	IK Gövde Sınıfı	IK08	
Fire Protection	Alev Koruması	650°C	
Cable Gland	Kablo Rakor	PG11	
Cable	Kablo	3x1,5mm ²	
RAL Code	Ral Kodu	1023	
Mounting Type	Montaj Tipi	Surface Mounted	Sıva Üstü

Optical Specifications Optik Özellikler

Light Source	Işık Kaynağı	Power LED	
Reflector	Reflektör	-	
Lens	Lens	PMMA	
Diffuser	Difüzör	Tempered Glass	Temperli Cam
CRI		>70	
Colour Temperature	Renk Sıcaklığı	3000K / 4000K / 6500K	
Photobiological Risk Group	Fotobiyolojik Risk Grubu	RG1	
Beam Angle	Işık Açısı	30° / 60° / 90°	

Electrical Specifications Elektriksel Özellikler

Input Voltage	Giriş Gerilimi	220-240Vac	
Frequency	Frekans	50-60Hz	
Class	Sınıf	I	
System Lifetime	Sistem Ömrü	>50.000h	
Power Factor	Güç Faktörü	>0,95	
Operating Temperature	Çalışma Sıcaklığı	-20°C / +55°C	
Standards	Standartlar	EN60598-2-1, EN62262, EN60529,	

Options Opsiyonlar

DALI		-	
1-10V		-	
Step DIM		-	
1hour Emergency Kit	1 Saat Acil Kit	-	
3hour Emergency Kit	3 Saat Acil Kit	-	
Electrical Protection	Elektriksel Sınıf	-	
Microwave Sensor	Radar Sensör	-	
RAL Code	RAL Kodu	✓	
Marine Painting	Marin Boya	-	

Code No Ürün Kodu	Power Güç (W)	Luminous Flux Işık Akısı (lm)	Colour Temp. Renk Sıcaklığı (K)	Efficacy Etkinlik Faktörü (lm/W)	Dimensions Boyutlar (mm) axbxc	Pcs / Pack Koli Adedi	Package Vol. Koli Hacmi (m ³)	Package Weight Koli Ağırlığı (kg)
111381	50	8250	6500	165	342x342x160	1	0,018	8
111380	75	12000	6500	160	342x342x160	1	0,018	8
111379	100	15500	6500	155	342x342x160	1	0,018	8
111378	125	19000	6500	152	342x342x160	1	0,018	8
111377	150	22500	6500	150	342x342x160	1	0,018	8
111053	200	28600	6500	143	342x342x160	1	0,018	8

Product codes can change by the kelvins, dimensions, or options. Please get in contact with the sales team. Ürün kodları kelvin, boyut ve opsiyonlar için değişebilir. Lütfen satış ekibi ile iletişime geçiniz. Technical values have tolerance +-%7 by the operating conditions. Teknik sonuçlar çalışma koşullarına bağlı olarak +-%7 toleransa sahiptir.

All your lighting needs in one address.
Tüm aydınlatma ihtiyaçlarınız için tek adres.



Technical Drawing

Teknik Çizim

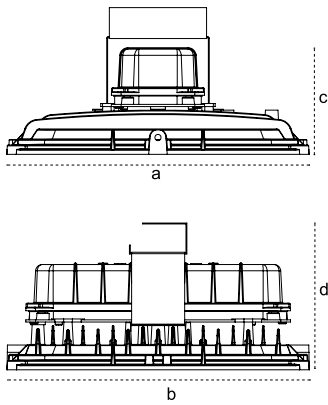

Cone Diagram

Konik Diagram

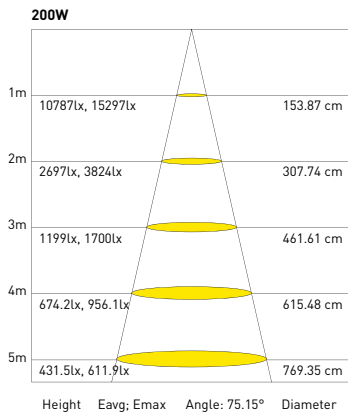

Light Distribution Curve

Işık Şiddeti Dağılım Eğrisi

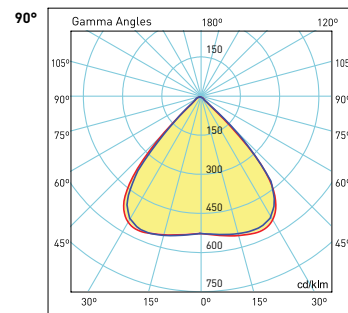
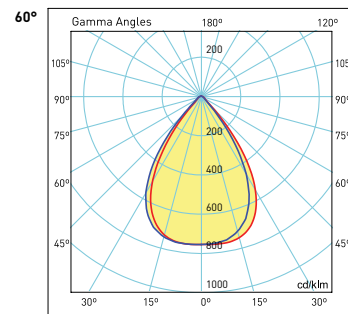
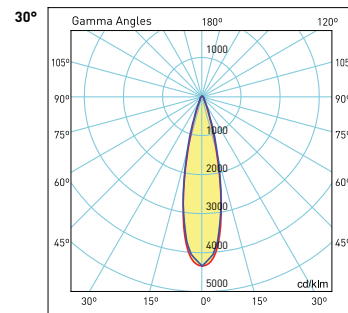

Visit our website for latest product informations and documents.
Güncel ürün bilgi ve belgeleri için web sitemizi ziyaret ediniz.



Pelsan



All your lighting needs in one address.
Tüm aydınlatma ihtiyaçlarınız için tek adres.



www.pelsan.com.tr
info@pelsan.com.tr | export@pelsan.com.tr

HEAD OFFICE
GENEL MERKEZ

Çerkeşli O.S.B.
İmes 5. Cadde No:12
Dilovası / Kocaeli - TÜRKİYE



/PelsanAydınlatma



pelsan-aydinlatma



pelsan aydinlatma



/pelsanaydinlatma



/PelsanLight

T : +9(0850) 460 75 76

F : +9(0216) 364 60 15