

# Pelsan

PIROLIZ

NAIRO

SIA



Ex-Proof Zone1/21  
Sayfa 41 

# ZONE1/21

## 2026/1

### FİYAT LİSTESİ

[www.pelsan.com.tr](http://www.pelsan.com.tr)

 İc Mekan  
Aydınlatma

 Endüstriyel  
Aydınlatma

 Dış Mekan  
Aydınlatma



# Zone2, Zone22 ATEX Belgeli Ex-Proof Armatürler

- Gaz Patlama Koruması: Zone 2
- Toz Patlama Koruması: Zone 22



## Inovaled G3

### Ex-Proof Etanj Armatür

- Gaz Patlama Koruması: Zone2
- Toz Patlama Koruması: Zone22
- II 3G Ex nR IIC T4 Gc
- II 3D Ex tc IIC (T135°C) Dc



# Zone2, Zone21 ATEX Belgeli Ex-Proof Armatürler

- Gaz Patlama Koruması: Zone 2
- Toz Patlama Koruması: Zone 21

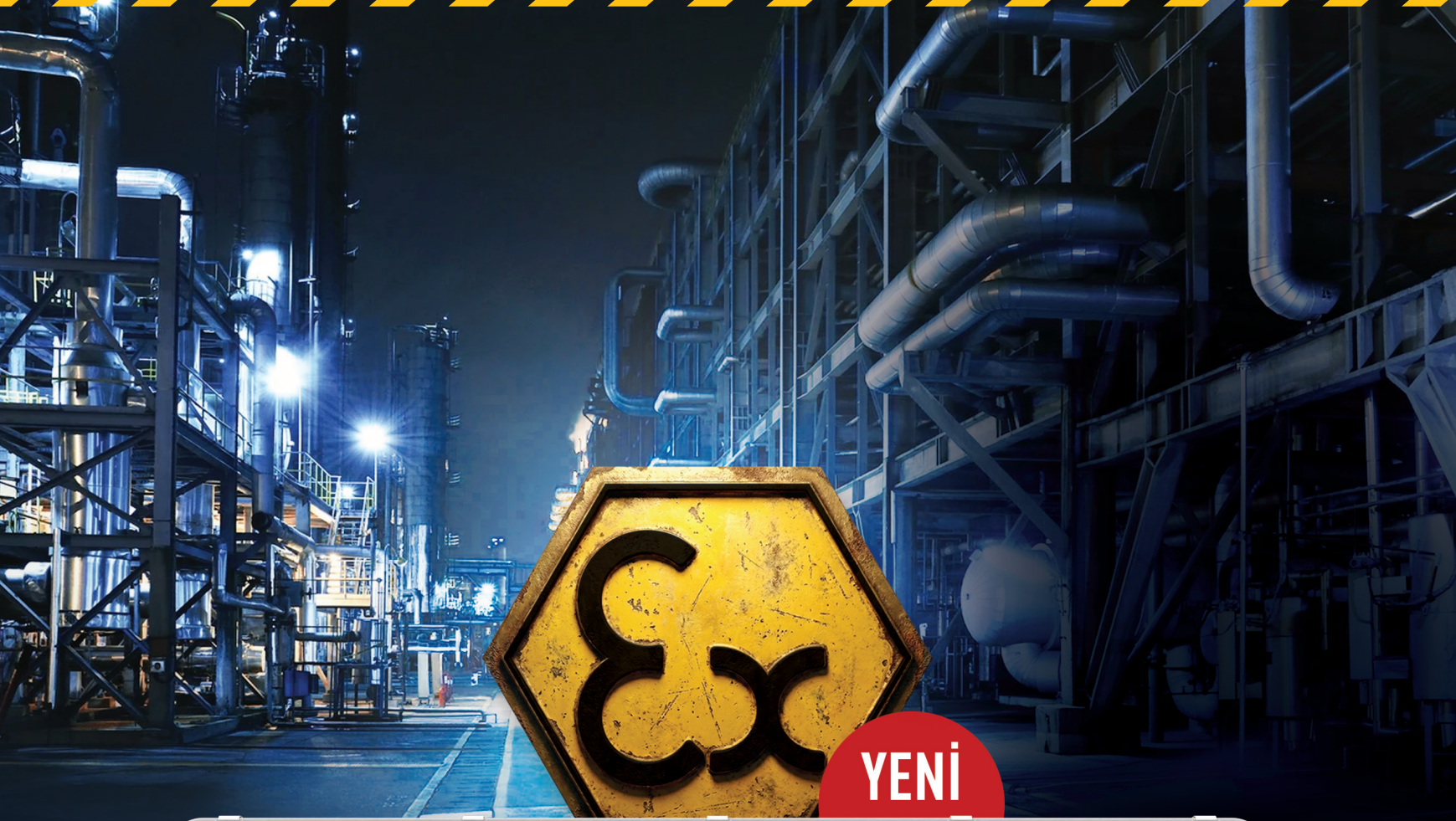

YENİ



**Largo G2**

**Ex-Proof Etanj Armatür**

- Gaz Patlama Koruması: Zone2
- Toz Patlama Koruması: Zone21
- II 3G Ex nR IIC T6 Gc
- II 2D Ex tb IIIC (T80°C) Db, IP65

Ex-Proof Largo G2  
Sayfa 42



## Diğer Zone 2/22 Armatürlerimiz

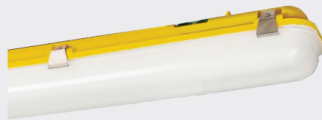

**Largo LED**  
Etanj Armatür



**Nairo**  
Projektör



**Sia**  
Yüksek Tavan Armatürü

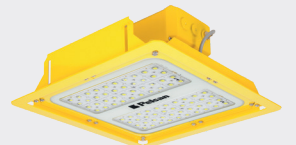

**Piroliz**  
Kanopi Armatürü

# 2026/1

## içindekiler



**06**

Backlight Ofis Armatürleri



**08**

Sıva Altı Özel Ofis Armatürü

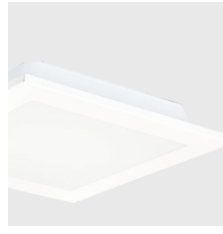

**09**

Clip-in Ofis Armatürleri



**10**

Sıva Üstü Ofis Armatürleri



**12**

Linear Armatürler



**14**

Downlight Armatürler

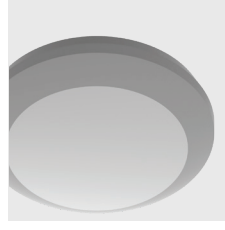

**18**

Tavan Duvar Armatürleri

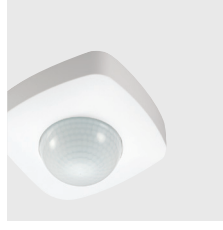

**20**

Sensörler



**24**

Acil Aydınlatma Armatürleri



**28**

Acil Yönlendirme Armatürleri



**29**

Taşınabilir Güç Kaynağı



**30**

Etanj Armatürler



**32**

LED Tube Etanj



**33**

110Vac 24Vac/dc Armatürler



**34**

Benzinlik Armatürleri



**35**

Yüksek Tavan  
Armatürleri



**39**

Ex-Proof  
Armatürler



**44**

Yüksek Güçlü  
Projektörler



**46**

Projektörler

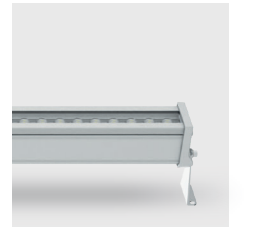

**48**

Wallwasher



**49**

Yol ve Cade  
Armatürleri



**52**

Park Bahçe  
Aydınlatma Armatürleri

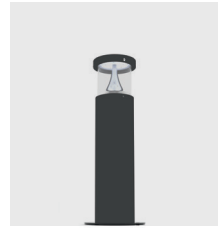

**59**

Bolardlar



**62**

Set Üstü  
Armatürler



**63**

Dış Mekan  
Aplikler



**66**

Çim Spotları ve  
Duvara Gömme  
Armatürleri



**68**

Sertifikalar

### Kurum Şartnamelerine Birebir Uyum

Isoled G3T

121 lm/W'a Varan Verimlilik

PMMA Difüzör

50.000 saat Driver Ömrü

Tarak PCB

5 YIL GARANTİ

TSE Belgesi

Avrupa Menşeli ENEC Belgeli Driver

PF PF > 0,95

55mm Kasa Yüksekliği

0,7mm Çerçeve Kalınlığı



Tarak PCB

### Isoled 60x60

Sıva Altı

Kod	Güç (W)	Renk Sıcaklığı (K)	Işık Akısı (lm)	Etkinlik Faktörü (lm/W)	Boyutlar (mm)axbxc	Kesim Ölçüsü (mm)	Koli Ağırlığı (kg)	Koli Adedi	Fiyat
111411	36	4000	4356	121	595x595x61	570x570	23,5	6	43,75\$
111412	36	6500	4356	121	595x595x61	570x570	23,5	6	43,75\$

<b>Özellikler</b>	Metal	PMMA Difüzör	3000/4000/6500K	IP40	LED Çip Ömrü L70 Tc@105°C >102.000h	LED Sürecü Ömrü Tc@65°C 50.000h	5 Yıl
<b>Opsiyonlar</b>	DALI	1-10V	Acil Aydınlatma (1-3 saat)	Clip-in	Alçıpan		



Tarak PCB

### Isoled 30x30

Sıva Altı

Kod	Güç (W)	Renk Sıcaklığı (K)	Işık Akısı (lm)	Etkinlik Faktörü (lm/W)	Boyutlar (mm)axbxc	Kesim Ölçüsü (mm)	Koli Ağırlığı (kg)	Koli Adedi	Fiyat
111342	12	4000	1440	120	295x295x61	270x270	7	5	21,00\$
111343	12	6500	1440	120	295x295x61	270x270	7	5	21,00\$

<b>Özellikler</b>	Metal	PMMA Difüzör	3000/4000/6500K	IP40	LED Çip Ömrü L70 Tc@105°C >102.000h	LED Sürecü Ömrü Tc@65°C 50.000h	5 Yıl
<b>Opsiyonlar</b>	DALI	1-10V	Acil Aydınlatma (1-3 saat)	Clip-in	Alçıpan		

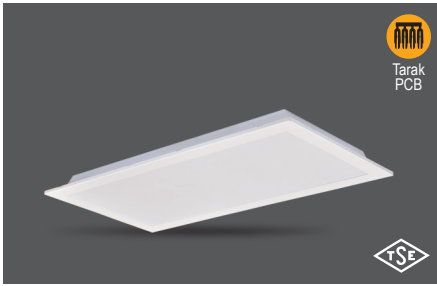

Tarak PCB

### Isoled 30x60

Sıva Altı

Kod	Güç (W)	Renk Sıcaklığı (K)	Işık Akısı (lm)	Etkinlik Faktörü (lm/W)	Boyutlar (mm)axbxc	Kesim Ölçüsü (mm)	Koli Ağırlığı (kg)	Koli Adedi	Fiyat
111461	17	4000	2040	120	595x295x61	570x270	12,54	5	36,75\$
111462	17	6500	2040	120	595x295x61	570x270	12,54	5	36,75\$

<b>Özellikler</b>	Metal	PMMA Difüzör	3000/4000/6500K	IP40	LED Çip Ömrü L70 Tc@105°C >102.000h	LED Sürecü Ömrü Tc@65°C 50.000h	5 Yıl
<b>Opsiyonlar</b>	DALI	1-10V	Acil Aydınlatma (1-3 saat)	Alçıpan			



Tarak PCB

### Isoled 30x120

Sıva Altı

Kod	Güç (W)	Renk Sıcaklığı (K)	Işık Akısı (lm)	Etkinlik Faktörü (lm/W)	Boyutlar (mm)axbxc	Kesim Ölçüsü (mm)	Koli Ağırlığı (kg)	Koli Adedi	Fiyat
111464	36	4000	4320	120	1195x295x61	1170x270	12,8	4	57,00\$
111465	36	6500	4320	120	1195x295x61	1170x270	12,8	4	57,00\$

<b>Özellikler</b>	Metal	PMMA Difüzör	3000/4000/6500K	IP40	LED Çip Ömrü L70 Tc@105°C >102.000h	LED Sürecü Ömrü Tc@65°C 50.000h	5 Yıl
<b>Opsiyonlar</b>	DALI	1-10V	Acil Aydınlatma (1-3 saat)	Alçıpan			

#### Opsiyonlar

Kod	Özellikler	Koli Adedi	Fiyat
327764	Isoled & Dekoled Acil Aydınlatma Kit Opsiyonu (1 saat)	1	27,60\$
331401	Isoled & Dekoled Acil Aydınlatma Kit Opsiyonu (3 saat)	1	31,60\$
323795	Isoled Alçıpan Yayı (4 adet) (60x60 için)	1	3,70\$
325628	Isoled Alçıpan Yayı (2 adet) (30x30 için)	1	1,85\$

Özellikler	Koli Adedi	Fiyat
DALI Dim	1	31,25\$



## Ekonomik Ofis Aydınlatma Çözümü

Isoled G3L

ENECE Belgeli  
Driver

50.000 saat  
Driver Ömrü

PF > 0,95

60x120



60x60

30x30

30x60

106 lm/W'a  
Varan Verimlilik

Opal  
Difüzör

5  
YIL  
GARANTİ

ENECE Belgeli  
Sürücü

TSE Belgesi



Lensli  
Modül

### Isoled 60x60

Sıva Altı

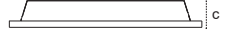

Kod	Güç (W)	Renk Sıcaklığı (K)	Işık Akısı (lm)	Etkinlik Faktörü (lm/W)	Boyutlar (mm)axbxc	Kesim Ölçüsü (mm)	Koli Ağırlığı (kg)	Koli Adedi	Fiyat
111474	36	4000	3816	106	595x595x45	570x570	22,5	6	36,25\$
111475	36	6500	3816	106	595x595x45	570x570	22,5	6	36,25\$

Özellikler	Metal	Opal Difüzör	3000/4000/6500K	IP40	LED Çip Ömrü L70 Tc@105°C > 102.000h.	LED Sürücü Ömrü Tc@65°C 50.000h	5 Yıl
Opsiyonlar	DALI	1-10V	Acil Aydınlatma (1-3 saat)	Clip-in	Alçıpan		



Lensli  
Modül

### Isoled 30x30

Sıva Altı

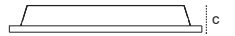

Kod	Güç (W)	Renk Sıcaklığı (K)	Işık Akısı (lm)	Etkinlik Faktörü (lm/W)	Boyutlar (mm)axbxc	Kesim Ölçüsü (mm)	Koli Ağırlığı (kg)	Koli Adedi	Fiyat
115346	12	4000	1200	100	295x295x45	270x270	7	5	17,50\$
115347	12	6500	1200	100	295x295x45	270x270	7	5	17,50\$

Özellikler	Metal	Opal Difüzör	3000/4000/6500K	IP40	LED Çip Ömrü L70 Tc@105°C > 102.000h.	LED Sürücü Ömrü Tc@65°C 50.000h	5 Yıl
Opsiyonlar	DALI	1-10V	Acil Aydınlatma (1-3 saat)	Clip-in	Alçıpan		

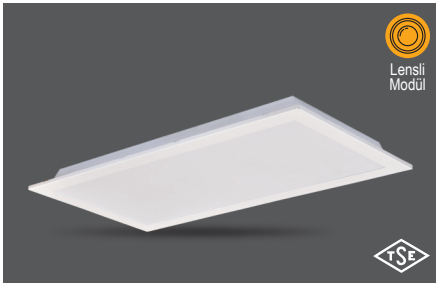

Lensli  
Modül

### Isoled 30x60

Sıva Altı

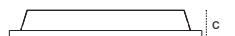

Kod	Güç (W)	Renk Sıcaklığı (K)	Işık Akısı (lm)	Etkinlik Faktörü (lm/W)	Boyutlar (mm)axbxc	Kesim Ölçüsü (mm)	Koli Ağırlığı (kg)	Koli Adedi	Fiyat
111821	17	4000	1751	103	595x295x45	270x570	11,4	6	28,50\$
111822	17	6500	1751	103	595x295x45	270x570	11,4	6	28,50\$

Özellikler	Metal	Opal Difüzör	3000/4000/6500K	IP40	LED Çip Ömrü L70 Tc@105°C > 102.000h.	LED Sürücü Ömrü Tc@65°C 50.000h	5 Yıl
Opsiyonlar	DALI	1-10V	Acil Aydınlatma (1-3 saat)	Clip-in	Alçıpan		



Lensli  
Modül

### Isoled 30x120

Sıva Altı

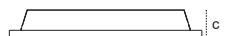

Kod	Güç (W)	Renk Sıcaklığı (K)	Işık Akısı (lm)	Etkinlik Faktörü (lm/W)	Boyutlar (mm)axbxc	Kesim Ölçüsü (mm)	Koli Ağırlığı (kg)	Koli Adedi	Fiyat
113008	36	4000	3888	108	1195x295x45	270x1170	12,8	4	47,25\$
113009	36	6500	3888	108	1195x295x45	270x1170	12,8	4	47,25\$

Özellikler	Metal	Opal Difüzör	3000/4000/6500K	IP40	LED Çip Ömrü L70 Tc@105°C > 102.000h.	LED Sürücü Ömrü Tc@65°C 50.000h	5 Yıl
Opsiyonlar	DALI	1-10V	Acil Aydınlatma (1-3 saat)	Clip-in	Alçıpan		



Lensli  
Modül

### Dealed 60x60

Sıva Altı



Kod	Güç (W)	Renk Sıcaklığı (K)	Işık Akısı (lm)	Etkinlik Faktörü (lm/W)	Boyutlar (mm)axbxc	Kesim Ölçüsü (mm)	Koli Ağırlığı (kg)	Koli Adedi	Fiyat
116173	36	4000	3708	103	595x595x33	570x570	15	10	25,25\$
116174	36	6500	3708	103	595x595x33	570x570	15	10	25,25\$

Özellikler	Metal	Opal Difüzör	3000/4000/6500K	IP40	LED Çip Ömrü L70 Tc@105°C > 102.000h.	LED Sürücü Ömrü Tc@65°C 50.000h	5 Yıl
Opsiyonlar	Acil Aydınlatma (1-3 saat)	Clip-in	Alçıpan				

Clealed

# IP65, Nemli ve Tozlu Ortamlar için Güvenilir Çözüm



### Clealed IP65

Sıva Altı



Kod	Güç (W)	Renk Sıcaklığı (K)	Işık Akısı (lm)	Etkinlik Faktörü (lm/W)	Boyutlar (mm)axbxc	Kesim Ölçüsü (mm)	Koli Ağırlığı (kg)	Koli Adedi	Fiyat
113695	12	4000	1416	118	295x295x61	280x280	7	5	34,50\$
113696	12	6500	1416	118	295x295x61	280x280	7	5	34,50\$
113277	36	4000	4248	118	595x595x61	580x580	15	6	65,00\$
113278	36	6500	4248	118	595x595x61	580x580	15	6	65,00\$

<b>Özellikler</b>	Metal	Opal Difüzör	3000/4000/6500K	IP65	LED Çip Ömrü L70 Tc@105°C > 102.000h.	LED Sürücü Ömrü Tc@65°C 50.000h.
<b>Opsiyonlar</b>	DALI	1-10V	Acil Aydınlatma (1-3 saat)	Clip-in	Alçıpan	



### IP65 Steril

Sıva Altı Temperli Camlı



Kod	Güç (W)	Renk Sıcaklığı (K)	Işık Akısı (lm)	Etkinlik Faktörü (lm/W)	Boyutlar (mm)axbxc	Kesim Ölçüsü (mm)	Koli Ağırlığı (kg)	Koli Adedi	Fiyat
109776	36	4000	3240	90	595x595x92	580x580	-	2	105,00\$
109777	36	6500	3240	90	595x595x92	580x580	-	2	105,00\$

<b>Özellikler</b>	Metal	Temperli Cam	3000/4000/6500K	IP65	LED Çip Ömrü L70 Tc@105°C > 102.000h.	LED Sürücü Ömrü Tc@65°C 50.000h.
<b>Opsiyonlar</b>	DALI	1-10V	Acil Aydınlatma (1-3 saat)	Alçıpan	Sıva Üstü	



### Divaled Endirekt

Sıva Altı / Sıva Üstü

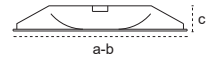

Kod	Tip	Güç (W)	Renk Sıcaklığı (K)	Işık Akısı (lm)	Etkinlik Faktörü (lm/W)	Boyutlar (mm)axbxc	Kesim Ölçüsü (mm)	Koli Ağırlığı (kg)	Koli Adedi	Fiyat
108125	Sıva Altı	42	4000	2940	70	595x595x72	580x580	16,36	4	69,00 \$
108408	Sıva Altı	42	6500	2940	70	595x595x72	580x580	16,36	4	69,00 \$
110601	Sıva Üstü	42	4000	2940	70	595x595x72	-	18	4	84,00 \$
110602	Sıva Üstü	42	6500	2940	70	595x595x72	-	18	4	84,00 \$

<b>Özellikler</b>	Metal	Opal Difüzör	3000/4000/6500K	IP20	LED Çip Ömrü L70 Tc@105°C > 102.000h.	LED Sürücü Ömrü Tc@65°C 50.000h.
<b>Opsiyonlar</b>	DALI	1-10V	Acil Aydınlatma (1-3 saat)	Clip-in	Alçıpan	Sıva Üstü





### Isoled 30x30



Kod	Güç (W)	Renk Sıcaklığı (K)	Işık Akısı (lm)	Etkinlik Faktörü (lm/W)	Boyutlar (mm)axbxc	Koli Ağırlığı (kg)	Koli Adedi	Fiyat
111582	12	4000	1200	100	300x300x55	7	5	22,30\$
111583	12	6500	1200	100	300x300x55	7	5	22,30\$







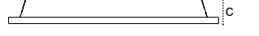





<b>Özellikler</b>	 Metal	 Opal Difüzör	 3000/4000/6500K	 IP40	 LED Çip Ömrü L70 Tc@105°C >102.000h.	 LED Sürücü Ömrü Tc@65°C 50.000h	 5 Yıl
<b>Opsiyonlar</b>	 DALI	 1-10V	 Acil Aydınlatma (1-3 saat)	 Clip-in	 Alçıpan		



### Isoled 60x60



Kod	Güç (W)	Renk Sıcaklığı (K)	Işık Akısı (lm)	Etkinlik Faktörü (lm/W)	Boyutlar (mm)axbxc	Koli Ağırlığı (kg)	Koli Adedi	Fiyat
111480	36	4000	3708	103	600x600x55	22,5	6	39,55\$
111481	36	6500	3708	103	600x600x55	22,5	6	39,55\$







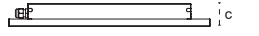





<b>Özellikler</b>	 Metal	 Opal Difüzör	 3000/4000/6500K	 IP40	 LED Çip Ömrü L70 Tc@105°C >102.000h.	 LED Sürücü Ömrü Tc@65°C 50.000h	 5 Yıl
<b>Opsiyonlar</b>	 DALI	 1-10V	 Acil Aydınlatma (1-3 saat)	 Clip-in	 Alçıpan		



### Cleared 30x30



Kod	Güç (W)	Renk Sıcaklığı (K)	Işık Akısı (lm)	Etkinlik Faktörü (lm/W)	Boyutlar (mm)axbxc	Koli Ağırlığı (kg)	Koli Adedi	Fiyat
113657	12	4000	1416	118	300x300x50	7	5	37,80\$
113658	12	6500	1416	118	300x300x50	7	5	37,80\$





<b>Özellikler</b>	 Metal	 Opal Difüzör	 3000/4000/6500K	 IP65	 LED Çip Ömrü L70 Tc@105°C >102.000h.	 LED Sürücü Ömrü Tc@65°C 50.000h	 5 Yıl
<b>Opsiyonlar</b>	 DALI	 1-10V	 Acil Aydınlatma (1-3 saat)	 Clip-in	 Alçıpan		

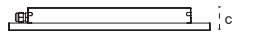

### Cleared 60x60



Kod	Güç (W)	Renk Sıcaklığı (K)	Işık Akısı (lm)	Etkinlik Faktörü (lm/W)	Boyutlar (mm)axbxc	Koli Ağırlığı (kg)	Koli Adedi	Fiyat
113261	36	4000	4464	124	600x600x50	15	5	68,30\$
111622	36	6500	4464	124	600x600x50	15	5	68,30\$

<b>Özellikler</b>	 Metal	 Opal Difüzör	 3000/4000/6500K	 IP65	 LED Çip Ömrü L70 Tc@105°C >102.000h.	 LED Sürücü Ömrü Tc@65°C 50.000h	 5 Yıl
<b>Opsiyonlar</b>	 DALI	 1-10V	 Acil Aydınlatma (1-3 saat)	 Clip-in	 Alçıpan		

**Dekoled G3T**

**Kurum Şartnamelerine Birebir Uyum**

121lm/W'a Varan Verimlilik

50.000 saat Driver Ömrü

Tarak PCB

PF PF>0,95

5 YIL GARANTİ

TSE Belgesi

Avrupa Menşei ENEC Belgeli Driver

PMMA Difüzör

61mm Kasa Yüksekliği

0,7mm Çerçeve Kalınlığı



Tarak PCB

TSE

**Dekoled 60x60**

Sıva Üstü

Kod	Güç (W)	Renk Sıcaklığı (K)	Işık Akısı (lm)	Etkinlik Faktörü (lm/W)	Boyutlar (mm)axbxc	Koli Ağırlığı (kg)	Koli Adedi	Fiyat
111439	36	4000	4356	121	600x600x61	25,6	6	51,25\$
111440	36	6500	4356	121	600x600x61	25,6	6	51,25\$

Özellikler Metal Opal Difüzör 3000/4000/6500K IP40 LED Çip Ömrü L70 Tc@105°C >102.000h LED Sürecü Ömrü Tc@65°C 50.000h 5 Yıl

Opsiyonlar DALI 1-10V Acil Aydınlatma (1-3 saat)



Tarak PCB

TSE

**Dekoled 30x30**

Sıva Üstü

Kod	Güç (W)	Renk Sıcaklığı (K)	Işık Akısı (lm)	Etkinlik Faktörü (lm/W)	Boyutlar (mm)axbxc	Koli Ağırlığı (kg)	Koli Adedi	Fiyat
111357	12	4000	1440	120	308x308x51	6,2	5	26,50\$
111358	12	6500	1440	120	308x308x51	6,2	5	26,50\$

Özellikler Metal Opal Difüzör 3000/4000/6500K IP40 LED Çip Ömrü L70 Tc@105°C >102.000h LED Sürecü Ömrü Tc@65°C 50.000h 5 Yıl

Opsiyonlar DALI 1-10V Acil Aydınlatma (1-3 saat)



Tarak PCB

TSE

**Dekoled 30x60**

Sıva Üstü

Kod	Güç (W)	Renk Sıcaklığı (K)	Işık Akısı (lm)	Etkinlik Faktörü (lm/W)	Boyutlar (mm)axbxc	Koli Ağırlığı (kg)	Koli Adedi	Fiyat
111455	17	4000	2040	120	308x600x61	11	5	43,25\$
111456	17	6500	2040	120	308x600x61	11	5	43,25\$

Özellikler Metal Opal Difüzör 3000/4000/6500K IP40 LED Çip Ömrü L70 Tc@105°C >102.000h LED Sürecü Ömrü Tc@65°C 50.000h 5 Yıl

Opsiyonlar DALI 1-10V Acil Aydınlatma (1-3 saat)



Tarak PCB

TSE

**Dekoled 30x120**

Sıva Üstü

Kod	Güç (W)	Renk Sıcaklığı (K)	Işık Akısı (lm)	Etkinlik Faktörü (lm/W)	Boyutlar (mm)axbxc	Koli Ağırlığı (kg)	Koli Adedi	Fiyat
111458	36	4000	4320	120	308x1200x61	20,5	4	68,25\$
111459	36	6500	4320	120	308x1200x61	20,5	4	68,25\$

Özellikler Metal Opal Difüzör 3000/4000/6500K IP40 LED Çip Ömrü L70 Tc@105°C >102.000h LED Sürecü Ömrü Tc@65°C 50.000h 5 Yıl

Opsiyonlar DALI 1-10V Acil Aydınlatma (1-3 saat)



Tarak PCB

TSE

**Dekoled 60x120**

Sıva Üstü

Kod	Güç (W)	Renk Sıcaklığı (K)	Işık Akısı (lm)	Etkinlik Faktörü (lm/W)	Boyutlar (mm)axbxc	Koli Ağırlığı (kg)	Koli Adedi	Fiyat
113392	72	4000	8640	120	600x1200x61	4,8	1	129,00\$
113393	72	6500	8640	120	600x1200x61	4,8	1	129,00\$

Özellikler Metal Opal Difüzör 3000/4000/6500K IP40 LED Çip Ömrü L70 Tc@105°C >102.000h LED Sürecü Ömrü Tc@65°C 50.000h 5 Yıl

Opsiyonlar DALI 1-10V Acil Aydınlatma (1-3 saat)



## Ekonomik Ofis Aydınlatma Çözümü

Dekoled G3L

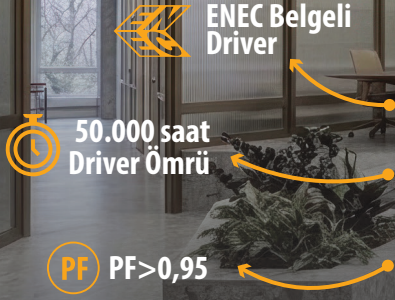
103 lm/W'a  
Varan VerimlilikOpal  
Difüzör5  
YIL  
GARANTİENEC Belgili  
SürücüTSE  
Belgili

### Dekoled 60x60

Sıva Üstü

Kod	Güç (W)	Renk Sıcaklığı (K)	Işık Akısı (lm)	Etkinlik Faktörü (lm/W)	Boyutlar (mm)axbxc	Koli Ağırlığı (kg)	Koli Adedi	Fiyat
111499	36	4000	3708	103	600x600x61	24,6	6	43,75\$
111500	36	6500	3708	103	600x600x61	24,6	6	43,75\$

Özellikler	Metal	Opal Difüzör	3000/4000/6500K	IP40	LED Çip Ömrü L70 Tc@105°C >102.000h.	LED Sürücü Ömrü Tc@65°C 50.000h	5 Yıl
Opsiyonlar	DALI	1-10V	Acil Aydınlatma (1-3 saat)				



### Dekoled 30x30

Sıva Üstü

Kod	Güç (W)	Renk Sıcaklığı (K)	Işık Akısı (lm)	Etkinlik Faktörü (lm/W)	Boyutlar (mm)axbxc	Koli Ağırlığı (kg)	Koli Adedi	Fiyat
115827	12	4000	1200	100	308x308x51	6,2	5	21,50\$
116110	12	6500	1200	100	308x308x51	6,2	5	21,50\$

Özellikler	Metal	Opal Difüzör	3000/4000/6500K	IP40	LED Çip Ömrü L70 Tc@105°C >102.000h.	LED Sürücü Ömrü Tc@65°C 50.000h	5 Yıl
Opsiyonlar	DALI	1-10V	Acil Aydınlatma (1-3 saat)				



### Dekoled 30x60

Sıva Üstü

Kod	Güç (W)	Renk Sıcaklığı (K)	Işık Akısı (lm)	Etkinlik Faktörü (lm/W)	Boyutlar (mm)axbxc	Koli Ağırlığı (kg)	Koli Adedi	Fiyat
111839	17	4000	1700	100	308x600x61	10,3	5	35,00\$
111840	17	6500	1700	100	308x600x61	10,3	5	35,00\$

Özellikler	Metal	Opal Difüzör	3000/4000/6500K	IP40	LED Çip Ömrü L70 Tc@105°C >102.000h.	LED Sürücü Ömrü Tc@65°C 50.000h	5 Yıl
Opsiyonlar	DALI	1-10V	Acil Aydınlatma (1-3 saat)				



### Dekoled 30x120

Sıva Üstü

Kod	Güç (W)	Renk Sıcaklığı (K)	Işık Akısı (lm)	Etkinlik Faktörü (lm/W)	Boyutlar (mm)axbxc	Koli Ağırlığı (kg)	Koli Adedi	Fiyat
113041	36	4000	3708	103	308x1200x61	20,5	4	56,50\$
113042	36	6500	3708	103	308x1200x61	20,5	4	56,50\$

Özellikler	Metal	Opal Difüzör	3000/4000/6500K	IP40	LED Çip Ömrü L70 Tc@105°C >102.000h.	LED Sürücü Ömrü Tc@65°C 50.000h	5 Yıl
Opsiyonlar	DALI	1-10V	Acil Aydınlatma (1-3 saat)				



### Dealed 60x60

Sıva Üstü

Kod	Güç (W)	Renk Sıcaklığı (K)	Işık Akısı (lm)	Etkinlik Faktörü (lm/W)	Boyutlar (mm)axbxc	Koli Ağırlığı (kg)	Koli Adedi	Fiyat
116175	36	4000	3708	103	595x595x67	15	6	34,20\$
116176	36	6500	3708	103	595x595x67	15	6	34,20\$

Özellikler	Metal	Opal Difüzör	3000/4000/6500K	IP40	LED Çip Ömrü L70 Tc@105°C >102.000h.	LED Sürücü Ömrü Tc@65°C 50.000h
Opsiyonlar	Acil Aydınlatma (1-3 saat)					

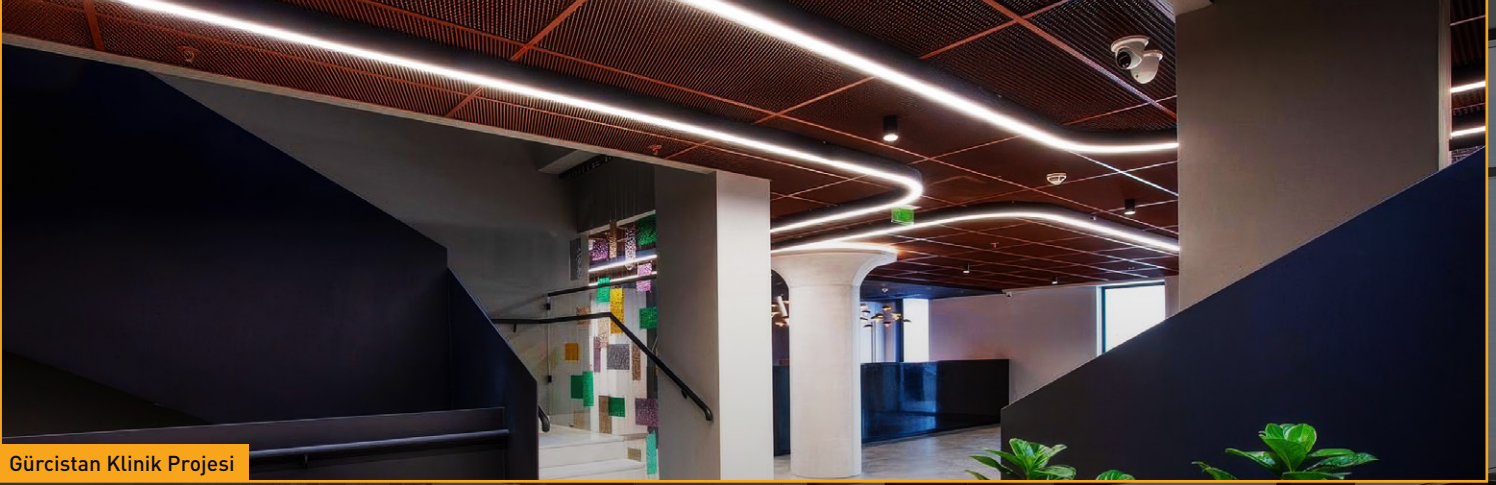

Gürcistan Klinik Projesi



Gürcistan Klinik Projesi

# Kesintisiz Lineer Bağlantı

*Linna*



İzmir Atatürk İl Halk Kütüphanesi



Samsun Müzesi



Müzeyyen Erkul Gaziantep Bilim Merkezi



Azerbaycan Sea Breeze



## Linna

Sıva Üstü



Kod	Güç (W)	Renk Sıcaklığı (K)	Işık Akısı (lm)	Etkinlik Faktörü (lm/W)	Boyutlar (mm)axbxc	Koli Ağırlığı (kg)	Koli Adedi	Fiyat
209137	20	4000	2000	100	50x70x500	19,2	24	32,25\$
209139	36	4000	3600	100	50x70x1000	19,1	12	64,45\$
209140	56	4000	5600	100	50x70x1500	27	12	96,65\$

## Özellikler

Alüminyum Opal Difüzör 3000/4000/6500K IP40 LED Çip Ömrü L70 Tc@105°C >102.000h LED Sürücü Ömrü Tc@65°C 50.000h

## Opsiyonlar

DALI 1-10V Acil Aydınlatma (1-3 saat) Through Wiring RAL 9016

## Linna T-X-L Bağlantı Armatürleri

Sıva Üstü

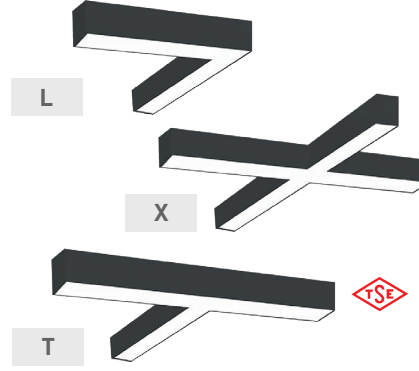
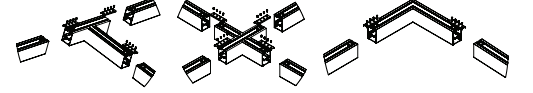

Kod	Tip	Güç (W)	Renk Sıcaklığı (K)	Işık Akısı (lm)	Etkinlik Faktörü (lm/W)	Boyutlar (mm)axbxc	Koli Ağırlığı (kg)	Koli Adedi	Fiyat
209739	L	20	4000	2000	100	270x70x290	0,598	1	35,60\$
209736	T	20	4000	2000	100	250x70x300	0,595	1	38,60\$
209742	X	20	4000	2000	100	250x70x300	0,77	1	45,60\$

## Özellikler

Alüminyum Opal Difüzör 3000/4000/6500K IP40 LED Çip Ömrü L70 Tc@105°C >102.000h LED Sürücü Ömrü Tc@65°C 50.000h Through Wiring

## Opsiyonlar

DALI 1-10V RAL 9016

## Trenta

Sıva Üstü

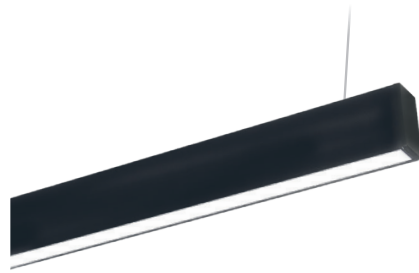

Kod	Güç (W)	Renk Sıcaklığı (K)	Işık Akısı (lm)	Etkinlik Faktörü (lm/W)	Boyutlar (mm)axbxc	Koli Ağırlığı (kg)	Koli Adedi	Fiyat
210236	14	4000	1120	80	500x33x58	0,6	1	32,25\$
210239	28	4000	2240	80	1000x33x58	1,1	1	57,75\$
210242	42	4000	3360	80	1500x33x58	1,6	1	96,50\$
210245	56	4000	4480	80	2000x33x58	2,2	1	115,50\$

## Özellikler

Alüminyum Opal Difüzör 3000/4000/6500K IP40 LED Çip Ömrü L70 Tc@105°C >102.000h LED Sürücü Ömrü Tc@65°C 50.000h

## Opsiyonlar

DALI 1-10V Acil Aydınlatma (1-3 saat)

## Eterna Endirekt (47mm)

Sıva Üstü

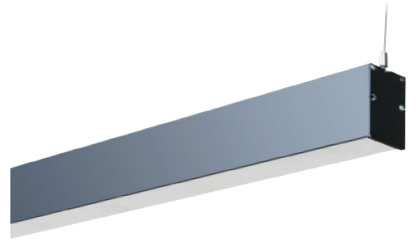

Kod	Güç (W)	Renk Sıcaklığı (K)	Işık Akısı (lm)	Etkinlik Faktörü (lm/W)	Boyutlar (mm)axbxc	Koli Ağırlığı (kg)	Koli Adedi	Fiyat
206015	26-16	4000	2600-1440	100-90	900x47x85	-	1	145,90\$
206016	34-18	4000	3400-1620	100-90	1200x47x85	-	1	161,45\$
206017	44-24	4000	4400-2160	100-90	1470x47x85	-	1	191,80\$
206018	60-40	4000	6000-3600	100-90	2000x47x85	-	1	296,55\$

## Özellikler

Alüminyum Opal Difüzör 3000/4000/6500K IP40 LED Çip Ömrü L70 Tc@105°C >102.000h LED Sürücü Ömrü Tc@65°C 50.000h

## Opsiyonlar

DALI 1-10V Acil Aydınlatma (1-3 saat) RAL 9016

## Linna

Sıva Altı



Kod	Güç (W)	Renk Sıcaklığı (K)	Işık Akısı (lm)	Etkinlik Faktörü (lm/W)	Boyutlar (mm)axbxc	Kesim Ölçüsü (mm)	Koli Ağırlığı (kg)	Koli Adedi	Fiyat
212267	14	4000	1260	90	640x77x85	620x62	1,15	1	44,40\$
212268	20	4000	1800	90	920x77x85	900x62	1,47	1	58,70\$
212269	28	4000	2520	90	1240x77x85	1220x62	1,77	1	71,40\$
212270	42	4000	3780	90	1520x77x85	1500x62	2,15	1	95,50\$

## Özellikler

Alüminyum Opal Difüzör 3000/4000/6500K IP40 50.000h

## Opsiyonlar

DALI 1-10V RAL 9016

Kod	Özellikler	Koli Adedi	Fiyat
304906	Askı Aparatı 100 cm (2 adet)	1	4,60\$
304915	Askı Aparatı 150 cm (2 adet)	1	5,60\$
317986	Askı Ronans Takımı 150 cm Siyah (2 Adet)	1	5,60\$
209870	Lineer Birleştirme Aparatı Takımı (2 Adet)	1	2,35\$

### Tira S

## Her Mekan için Tira S



### Tira S Sıva Altı

Kod	Güç (W)	Renk Sıcaklığı (K)	Işık Akısı (lm)	Etkinlik Faktörü (lm/W)	Boyutlar (mm)Øxh	Kesim Ölçüsü (mm)	Koli Ağırlığı (kg)	Koli Adedi	Fiyat
210164	10	4000	1000	100	110x41	100	5,04	24	33,60\$
210168	15	4000	1860	124	175x41	165	12,4	24	38,45\$
210170	20	4000	2440	122	175x41	165	9,1	18	44,10\$
210172	20	4000	2460	123	225x41	215	9,1	18	53,50\$
210174	30	4000	3660	122	225x41	215	9,1	18	63,70\$
210176	35	4000	4235	121	225x41	215	9,1	18	74,50\$

Özellikler	Alüminyum	Opal Difüzör	3000/4000/6500K	IP40	LED Çip Ömrü L70 Tc@105°C >102.000h.	LED Sürücü Ömrü Tc@65°C 50.000h	5 Yıl
Opsiyonlar	DALI	1-10V	Acil Aydınlatma (1-3 saat)	RAL 9005			

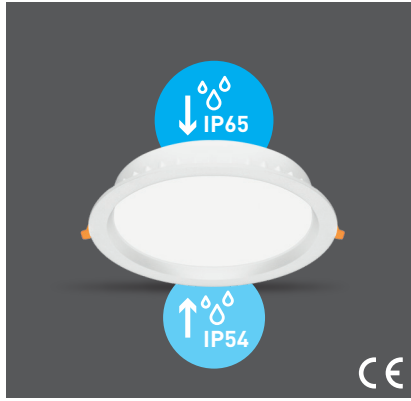

### Tira S IP54/IP65 Sıva Altı

Kod	Güç (W)	Renk Sıcaklığı (K)	Işık Akısı (lm)	Etkinlik Faktörü (lm/W)	Boyutlar (mm)Øxh	Kesim Ölçüsü (mm)	Koli Ağırlığı (kg)	Koli Adedi	Fiyat
210185	10	4000	1000	100	110x41	100	6	24	48,60\$
210189	15	4000	1860	124	175x41	165	13	24	53,45\$
210191	20	4000	2440	122	175x41	165	10	18	59,10\$
210199	20	4000	2460	123	225x41	215	10	18	68,50\$
210392	30	4000	3660	122	225x41	215	10	18	78,70\$
210203	35	4000	4235	121	225x41	215	10	18	89,50\$

Özellikler	Alüminyum	Opal Difüzör	3000/4000/6500K	IP54 / IP65	LED Çip Ömrü L70 Tc@105°C >102.000h.	LED Sürücü Ömrü Tc@65°C 50.000h	5 Yıl
Opsiyonlar	DALI	1-10V	Acil Aydınlatma (1-3 saat)	RAL 9005			



### Tira S Sıva Üstü

Kod	Güç (W)	Renk Sıcaklığı (K)	Işık Akısı (lm)	Etkinlik Faktörü (lm/W)	Boyutlar (mm)Øxh	Koli Ağırlığı (kg)	Koli Adedi	Fiyat
210673	10	4000	1000	100	110x66	-	24	41,85\$
210677	15	4000	1860	124	157x66	-	24	46,70\$
210683	20	4000	2440	122	157x66	-	18	52,35\$
210685	20	4000	2460	123	209x68	-	18	61,75\$
210687	30	4000	3660	122	209x68	-	18	71,95\$
210689	35	4000	4235	121	209x68	-	18	82,75\$

Özellikler	Alüminyum	Opal Difüzör	3000/4000/6500K	IP40	LED Çip Ömrü L70 Tc@105°C >102.000h.	LED Sürücü Ömrü Tc@65°C 50.000h	5 Yıl
Opsiyonlar	DALI	1-10V	Acil Aydınlatma (1-3 saat)	RAL 9005			

Kod	Özellikler	Koli Adedi	Fiyat
327764	Downlight Acil Aydınlatma Kit Opsiyonu (1saat)	1	27,60 \$
331401	Downlight Acil Aydınlatma Kit Opsiyonu (3saat)	1	31,60 \$



## Tek Ölçüde Çok Yönlü Kullanım



### Rita G2

Sıva Altı



Kod	Güç (W)	Renk Sıcaklığı (K)	Işık Akısı (lm)	Etkinlik Faktörü (lm/W)	Boyutlar (mm)Øxh	Kesim Ölçüsü (mm)	Koli Ağırlığı (kg)	Koli Adedi	Fiyat
116197	10	4000	1240	124	145x30	120	9	30	19,00\$
116480	14	4000	1736	124	145x30	120	9	30	24,00\$
116200	20	4000	2300	115	145x30	120	9	30	24,50\$

Özellikler	Alüminyum	Opal Difüzör	3000/4000/6500K	IP40	LED Çip Ömrü L70 Tc@105°C >102.000h.	LED Sürücü Ömrü Tc@65°C 50.000h	2 Yıl
Opsiyonlar	DALI	1-10V	Acil Aydınlatma (1-3 saat)				

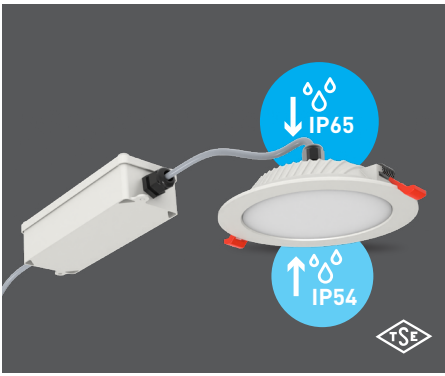

### Rita G2 IP54/IP65

Sıva Altı



Kod	Güç (W)	Renk Sıcaklığı (K)	Işık Akısı (lm)	Etkinlik Faktörü (lm/W)	Boyutlar (mm)Øxh	Kesim Ölçüsü (mm)	Koli Ağırlığı (kg)	Koli Adedi	Fiyat
116624	10	4000	1240	124	145x35	120	10	20	34,00\$
116625	14	4000	1736	124	145x35	120	10	20	39,00\$
116626	20	4000	2300	115	145x35	120	10	20	39,50\$

Özellikler	Alüminyum	Opal Difüzör	3000/4000/6500K	IP54/65	LED Çip Ömrü L70 Tc@105°C >102.000h.	LED Sürücü Ömrü Tc@65°C 50.000h	2 Yıl
Opsiyonlar	DALI	1-10V	Acil Aydınlatma (1-3 saat)				



### Rita G2

Sıva Üstü

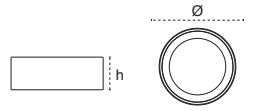

Kod	Güç (W)	Renk Sıcaklığı (K)	Işık Akısı (lm)	Etkinlik Faktörü (lm/W)	Boyutlar (mm)Øxh	Koli Ağırlığı (kg)	Koli Adedi	Fiyat
116254	10	4000	1240	124	150x90	11	20	27,25\$
116524	14	4000	1736	124	150x90	11	20	32,25\$
116251	20	4000	2300	115	150x90	11	20	32,75\$

Özellikler	Alüminyum	Opal Difüzör	3000/4000/6500K	IP40	LED Çip Ömrü L70 Tc@105°C >102.000h.	LED Sürücü Ömrü Tc@65°C 50.000h	2 Yıl
Opsiyonlar	DALI	Acil Aydınlatma (1-3 saat)					

Kod	Özellikler	Koli Adedi	Fiyat
327764	Downlight Acil Aydınlatma Kit Opsiyonu (1saat)	1	27,60 \$
331401	Downlight Acil Aydınlatma Kit Opsiyonu (3saat) DALI Dim Farkı	1	31,60 \$ 31,25 \$

## En Verimli Downlight

135lm/W

Dore

Slim Tasarım

135lm/W'a  
Varan Verimlilik

PF > 0,95

ENEC Belgeli  
Driver

7W-22W  
Güç Seçeneği

Sıva Üstü/Sıva Altı  
Montaj Opsiyonu



Sıva Altı

Sıva Üstü



### Dore 7W

Sıva Altı

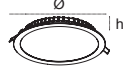

Kod	Güç (W)	Renk Sıcaklığı (K)	Işık Akısı (lm)	Etkinlik Faktörü (lm/W)	Boyutlar (mm)Øxh	Kesim Ölçüsü (mm)	Koli Ağırlığı (kg)	Koli Adedi	Fiyat
110864	7	4000	791	113	120x45	105	6	30	13,65\$

Özellikler: ABS-PC, Opal Difüzör, 3000/4000/6500K, IP40, LED Çip Ömrü L70 Tc@105°C >102.000h, LED Sürücü Ömrü Tc@65°C 30.000h, 5 Yıl

Opsiyonlar: DALI, 1-10V, Acil Aydınlatma (1-3 saat)



### Dore 10W/13W

Sıva Altı

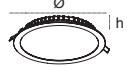

Kod	Güç (W)	Renk Sıcaklığı (K)	Işık Akısı (lm)	Etkinlik Faktörü (lm/W)	Boyutlar (mm)Øxh	Kesim Ölçüsü (mm)	Koli Ağırlığı (kg)	Koli Adedi	Fiyat
110865	10	4000	1120	112	170x45	155	10	30	17,10\$
110866	13	4000	1547	119	170x45	155	10	30	19,50\$

Özellikler: ABS-PC, Opal Difüzör, 3000/4000/6500K, IP40, LED Çip Ömrü L70 Tc@105°C >102.000h, LED Sürücü Ömrü Tc@65°C 30.000h, 5 Yıl

Opsiyonlar: DALI, 1-10V, Acil Aydınlatma (1-3 saat)



### Dore 18W/22W

Sıva Altı

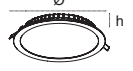

Kod	Güç (W)	Renk Sıcaklığı (K)	Işık Akısı (lm)	Etkinlik Faktörü (lm/W)	Boyutlar (mm)Øxh	Kesim Ölçüsü (mm)	Koli Ağırlığı (kg)	Koli Adedi	Fiyat
110867	18	4000	2430	135	225x45	205	11,4	20	25,70\$
110868	22	4000	2860	130	225x45	205	11,4	20	26,95\$

Özellikler: ABS-PC, Opal Difüzör, 3000/4000/6500K, IP40, LED Çip Ömrü L70 Tc@105°C >102.000h, LED Sürücü Ömrü Tc@65°C 30.000h, 5 Yıl

Opsiyonlar: DALI, 1-10V, Acil Aydınlatma (1-3 saat)



### Dore 18W/22W

Sıva Üstü

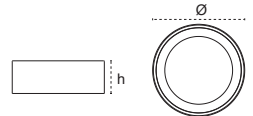

Kod	Güç (W)	Renk Sıcaklığı (K)	Işık Akısı (lm)	Etkinlik Faktörü (lm/W)	Boyutlar (mm)Øxh	Koli Ağırlığı (kg)	Koli Adedi	Fiyat
111752	18	4000	2430	135	228x55	7,2	10	33,95\$
111755	22	4000	2860	130	228x55	7,2	10	35,20\$

Özellikler: ABS-PC, Opal Difüzör, 3000/4000/6500K, IP40, LED Çip Ömrü L70 Tc@105°C >102.000h, LED Sürücü Ömrü Tc@65°C 30.000h, 5 Yıl

Opsiyonlar: DALI, 1-10V, Acil Aydınlatma (1-3 saat)

Kod	Özellikler	Koli Adedi	Fiyat
327764	Acil Aydınlatma Kiti (1 saat)	1	27,60\$
331401	Acil Aydınlatma Kiti (3 saat)	1	31,60\$



Sıradan Armatürlere Göre  
2.09 Kat Daha Fazla  
Işık Sunar



### Sirma 6W/9W

Sıva Altı

Kod	Güç (W)	Renk Sıcaklığı (K)	Işık Akısı (lm)	Etkinlik Faktörü (lm/W)	Boyutlar (mm)Øxh	Kesim Ölçüsü (mm)	Koli Ağırlığı (kg)	Koli Adedi	Fiyat
110330	6	3000	528	88	120x45	105	2,5	20	5,10\$
110331	6	4000	528	88	120x45	105	2,5	20	5,10\$
110332	6	6500	528	88	120x45	105	2,5	20	5,10\$
110334	9	4000	783	87	120x45	105	2,5	20	6,70\$
110335	9	6500	783	87	120x45	105	2,5	20	6,70\$

Özellikler: ABS-PC, Opal Difüzör, 3000/4000/6500K, IP40, 30.000h  
Opsiyonlar: Acil Aydınlatma (1-3 saat), 3 Yıl



### Sirma 12W/15W

Sıva Altı

Kod	Güç (W)	Renk Sıcaklığı (K)	Işık Akısı (lm)	Etkinlik Faktörü (lm/W)	Boyutlar (mm)Øxh	Kesim Ölçüsü (mm)	Koli Ağırlığı (kg)	Koli Adedi	Fiyat
110339	12	3000	1092	91	170x45	155	3,1	15	7,95\$
110340	12	4000	1092	91	170x45	155	3,1	15	7,95\$
110341	12	6500	1092	91	170x45	155	3,1	15	7,95\$
110343	15	4000	1350	90	170x45	155	3,1	15	9,90\$
110344	15	6500	1350	90	170x45	155	3,1	15	9,90\$

Özellikler: ABS-PC, Opal Difüzör, 3000/4000/6500K, IP40, 30.000h  
Opsiyonlar: Acil Aydınlatma (1-3 saat), 3 Yıl



### Sirma 18W/24W

Sıva Altı

Kod	Güç (W)	Renk Sıcaklığı (K)	Işık Akısı (lm)	Etkinlik Faktörü (lm/W)	Boyutlar (mm)Øxh	Kesim Ölçüsü (mm)	Koli Ağırlığı (kg)	Koli Adedi	Fiyat
115751	18	3000	1782	99	195x45	175	3,7	10	11,00\$
115752	18	4000	1782	99	195x45	175	3,7	10	11,00\$
115822	18	6500	1782	99	195x45	175	3,7	10	11,00\$
116303	24	4000	2040	85	225x45	205	3,7	10	11,90\$
116304	24	6500	2040	85	225x45	205	3,7	10	11,90\$

Özellikler: ABS-PC, Opal Difüzör, 3000/4000/6500K, IP40, 30.000h  
Opsiyonlar: Acil Aydınlatma (1-3 saat), 3 Yıl



### Sirma Sıva Üstü

Sıva Üstü

Kod	Güç (W)	Renk Sıcaklığı (K)	Işık Akısı (lm)	Etkinlik Faktörü (lm/W)	Boyutlar (mm)Øxh	Koli Ağırlığı (kg)	Koli Adedi	Fiyat
116047	24	3000	2376	99	228x55	5,2	10	16,90\$
116048	24	4000	2376	99	228x55	5,2	10	16,90\$
116049	24	6500	2376	99	228x55	5,2	10	16,90\$

Özellikler: ABS-PC, Opal Difüzör, 3000/4000/6500K, IP40, 30.000h, 3 Yıl





Kod	Özellikler	Koli Adedi	Fiyat
313117	Acil Aydınlatma Kit Opsiyonu (1 saat)	1	27,60\$



**Toz ve Su Almaz**



**Vidasız Çerçeve ile  
Mükemmel Görünüm**

-  TSE Belgeli
-  5 Yıl Garanti
-  IP66, Toz ve Su Almaz
-  Radar Sensör
-  Acil Aydınlatma (1-3 saat)



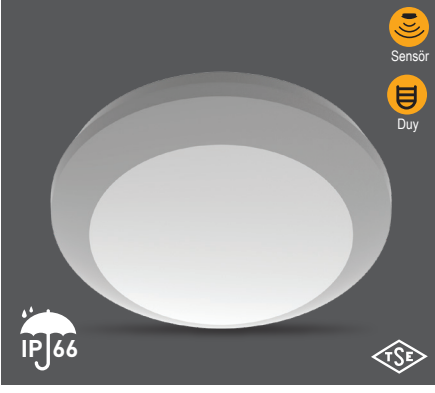

## Havana G2 - E27 Duylu

Kod	Tip	Güç (W)	Renk Sıcaklığı (K)	Işık Akısı (lm)	Etkinlik faktörü (lm/W)	Boyutlar (mm)Øxh	Koli Ağırlığı (kg)	Koli Adedi	Fiyat
111193	1xE27	max.20	-	-	-	260x87	5,8	8	18,70\$
111194	2xE27	max.20	-	-	-	260x87	5,8	8	19,90\$
111220	1xE27+Sensör	max.20	-	-	-	260x87	5,8	8	35,00\$
111223	2xE27+Sensör	max.20	-	-	-	260x87	5,8	8	36,30\$

Özellikler	Polimer Enjeksiyon	Opal Difüzör	3000/4000/6500K	IP66
Opsiyonlar	Radar Sensör	RAL 9010		

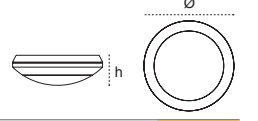

## Havana G2 - LED - ENEC Driver

Kod	Tip	Güç (W)	Renk Sıcaklığı (K)	Işık Akısı (lm)	Etkinlik faktörü (lm/W)	Boyutlar (mm)Øxh	Koli Ağırlığı (kg)	Koli Adedi	Fiyat
116550	LED	18	6500	1980	110	260x87	5,8	8	34,00\$
116551	LED + Sensör	18	6500	1980	110	260x87	5,8	8	50,60\$
116552	LED + Acil Ayd. Kitli	18	6500	1980	110	260x87	5,8	8	61,60\$
116553	LED + Acil Ayd. Kitli + Sensör	18	6500	1980	110	260x87	5,8	8	78,85\$

Özellikler	Polimer Enjeksiyon	Opal Difüzör	3000/4000/6500K	IP66	LED Çip Ömrü L70 Tc@105°C >102.000h.	LED Sürücü Ömrü Tc@65°C 50.000h.
Opsiyonlar	DALI	Acil Aydınlatma (1-3 saat)	Radar Sensör			

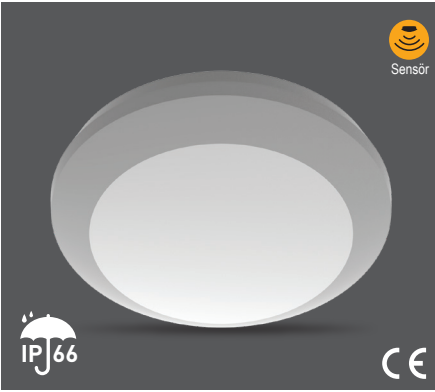
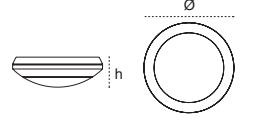

## Havana G2 - LED - Integrated Driver

Kod	Tip	Güç (W)	Renk Sıcaklığı (K)	Işık Akısı (lm)	Etkinlik faktörü (lm/W)	Boyutlar (mm)Øxh	Koli Ağırlığı (kg)	Koli Adedi	Fiyat
111692	Integrated Driver	18	6500	1530	85	260x87	5,8	8	27,05\$
111701	Integrated Driver + Sensör	18	6500	1530	85	260x87	5,8	8	43,60\$

Özellikler	Polimer Enjeksiyon	Opal Difüzör	3000/4000/6500K	IP66	LED Sürücü Ömrü Tc@65°C 30.000h.
Opsiyonlar	Radar Sensör				

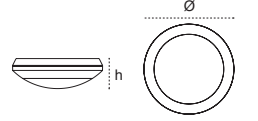

## Sense (2xE27)

Kod	Tip	Güç (W)	Renk Sıcaklığı (K)	Işık Akısı (lm)	Etkinlik Faktörü (lm/W)	Boyutlar (mm)Øxh	Koli Ağırlığı (kg)	Koli Adedi	Fiyat
110695	2xE27	-	-	-	-	300x105	13	8	8,05\$
110917	2xE27 Sensörlü	-	-	-	-	300x105	13	8	17,60\$
110697	2xE27 Sensörlü+Acil Ayd.	-	-	-	-	300x105	13	8	20,00\$

Özellikler	Metal	Cam	IP20
------------	-------	-----	------

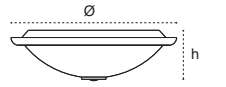

## Sense LED

Kod	Tip	Güç (W)	Renk Sıcaklığı (K)	Işık Akısı (lm)	Etkinlik Faktörü (lm/W)	Boyutlar (mm)Øxh	Koli Ağırlığı (kg)	Koli Adedi	Fiyat
110696	Sensörlü	8	6500	864	108	300x105	13	8	17,10\$
104369	Sensörlü + Acil Ayd.	8	6500	864	108	300x105	13	8	28,25\$

Özellikler	Metal	Cam	6500K	IP20	50.000h
------------	-------	-----	-------	------	---------

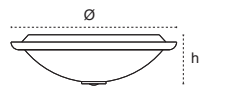



**Pelsan**

**IP54/65**

**SENSÖRLER İLE  
DIŐ MEKANLARDA GÜVENLİ KULLANIM**

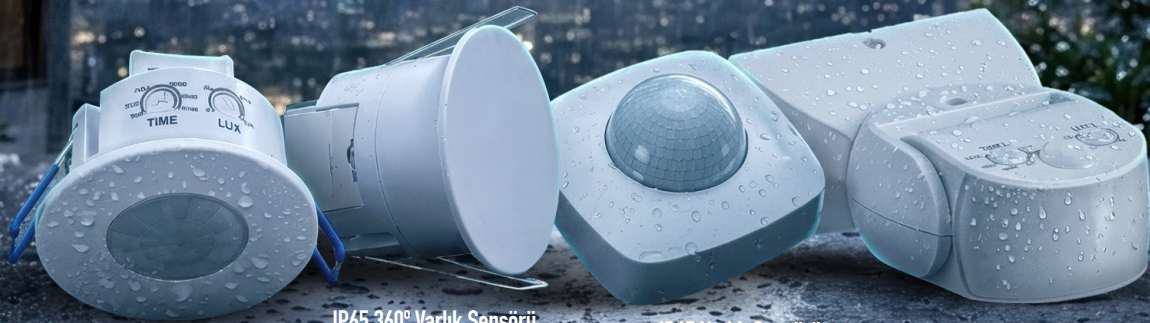

IP54 Sıva Altı Tavan Sensörü  
333964

IP65 360° Varlık Sensörü  
333963

IP65 Varlık Sensörü  
333966

IP65 180°-360° PIR Hareket Sensörü  
336189



## Radar Sensörü

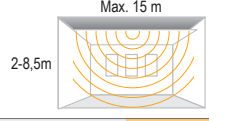

Kod	Tip	Algılama Mesafesi (m)	Montaj Yüksekliği (m)	Boyutlar (mm)axb	Koli Ağırlığı (kg)	Koli Adedi	Fiyat
314735	IP65 Sensör Kutusu	-	-	134x65,5	-	50	11,45\$
314725	Radar Sensör	Max. 15	2-8,5	93x47x44	9,8	100	16,00\$

Özellikler       



## Sıva Üstü Radar Sensörü

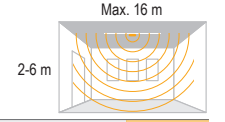

Kod	Algılama Mesafesi (m)	Montaj Yüksekliği (m)	Boyutlar (mm)Øxh	Koli Ağırlığı (kg)	Koli Adedi	Fiyat
326839	Max. 16	2-6	114x22	8,06	50	16,20\$

Özellikler       



## 360° Varlık Sensörü

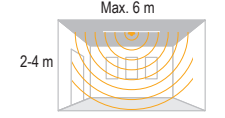

Kod	Algılama Mesafesi (m)	Montaj Yüksekliği (m)	Boyutlar (mm)Øxh	Koli Ağırlığı (kg)	Koli Adedi	Fiyat
333967	Max. 6	2-4	114x22	-	50	23,20\$

Özellikler     



## Sıva Altı Radar Sensörü

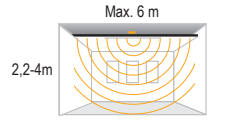

Kod	Algılama Mesafesi (m)	Montaj Yüksekliği (m)	Boyutlar (mm)Øxh	Kesim Ölçüsü (mm)	Koli Ağırlığı (kg)	Koli Adedi	Fiyat
326838	Max. 6	2,2-4	76x74,4	66	7,5	50	16,20\$

Özellikler       



## IP65 360° Varlık Sensörü

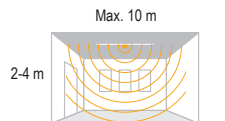

Kod	Algılama Mesafesi (m)	Montaj Yüksekliği (m)	Boyutlar (mm)Øxh	Kesim Ölçüsü (mm)	Koli Ağırlığı (kg)	Koli Adedi	Fiyat
333963	Max. 10	2-4	76x63	66	-	50	36,00\$

Özellikler     



### 360° Hareket Sensörü

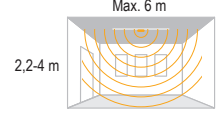

Kod	Algılama Mesafesi (m)	Montaj Yüksekliği (m)	Boyutlar (mm)Øxh	Koli Ağırlığı (kg)	Koli Adedi	Fiyat
314720	Max. 6	2,2-4	80x41	6,2	50	10,15\$

Özellikler

- Polimer Enjeksiyon
- IP20
- Zaman Ayan
- Lux Ayan
- Sun Modu
- Moon Modu



### Varlık Sensörü

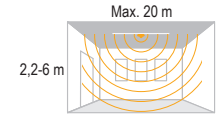

Kod	Algılama Mesafesi (m)	Montaj Yüksekliği (m)	Boyutlar (mm)Øxh	Koli Ağırlığı (kg)	Koli Adedi	Fiyat
314733	Max. 20	2,2-6	102,5x58,3	10	50	26,00\$

Özellikler

- Polimer Enjeksiyon
- IP20
- Zaman Ayan
- Lux Ayan
- Sun Modu
- Moon Modu



### IP65 Varlık Sensörü

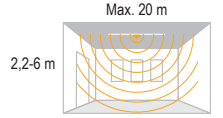

Kod	Algılama Mesafesi (m)	Montaj Yüksekliği (m)	Boyutlar (mm)Øxh	Koli Ağırlığı (kg)	Koli Adedi	Fiyat
333966	Max. 20	2,2-6	59x103	-	50	30,10\$

Özellikler

- Polimer Enjeksiyon
- IP65
- Zaman Ayan
- Lux Ayan
- Sun Modu



### Sıva Altı Tavan Sensörü

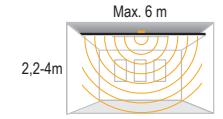

Kod	Algılama Mesafesi (m)	Montaj Yüksekliği (m)	Boyutlar (mm)axbxc	Kesim Ölçüsü (mm)	Koli Ağırlığı (kg)	Koli Adedi	Fiyat
314726	Max. 6	2,2-4	50x66,5x40	65	7	50	11,80\$

Özellikler

- Polimer Enjeksiyon
- IP20
- Zaman Ayan
- Lux Ayan
- Sun Modu
- Moon Modu



### IP65 Sıva Altı Tavan Sensörü

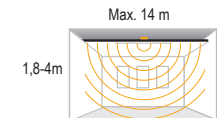

Kod	Algılama Mesafesi (m)	Montaj Yüksekliği (m)	Boyutlar (mm)Øxh	Kesim Ölçüsü (mm)	Koli Ağırlığı (kg)	Koli Adedi	Fiyat
333964	Max. 14	1,8-4	76x49	66	-	50	16,00\$

Özellikler

- Polimer Enjeksiyon
- IP65
- Zaman Ayan
- Lux Ayan
- Sun Modu





### Koridor Sensörü

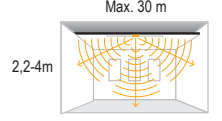

Kod	Algılama Mesafesi (m)	Montaj Yüksekliği (m)	Boyutlar (mm)Øxh	Koli Ağırlığı (kg)	Koli Adedi	Fiyat
333965	Max. 30	2,2-4	53x103	-	50	35,60\$

Özellikler     



### 180° Hareket Sensörü

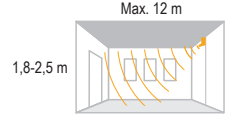

Kod	Algılama Mesafesi (m)	Montaj Yüksekliği (m)	Boyutlar (mm)axbxc	Koli Ağırlığı (kg)	Koli Adedi	Fiyat
314717	Max. 12	1,8-2,5	135x120x66	12,5	50	9,75\$

Özellikler      



### IP65 180° - 360° PIR Hareket Sensörü

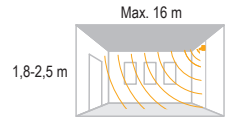

Kod	Algılama Mesafesi (m)	Montaj Yüksekliği (m)	Boyutlar (mm)axbxc	Koli Ağırlığı (kg)	Koli Adedi	Fiyat
336189	16	1,8 -2,5	119,5x80x51,5	-	50	Fiyat Sorunuz

Özellikler      



### 180° - 360° Yuvarlak PIR Hareket Sensörü

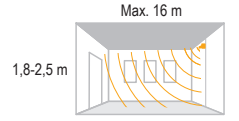

Kod	Algılama Mesafesi (m)	Montaj Yüksekliği (m)	Boyutlar (mm)axb	Koli Ağırlığı (kg)	Koli Adedi	Fiyat
336188	16	1,8 -2,5	80,2x80	-	50	Fiyat Sorunuz

Özellikler      



### 360° PIR Varlık Sensörü

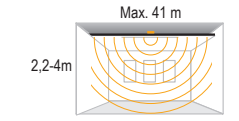

Kod	Algılama Mesafesi (m)	Montaj Yüksekliği (m)	Boyutlar (mm)Øxh	Koli Ağırlığı (kg)	Koli Adedi	Fiyat
336187	41	2,2-4	115x73	-	50	Fiyat Sorunuz

Özellikler       



### Yüksek Tavan Sensörü

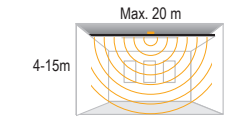

Kod	Algılama Mesafesi (m)	Montaj Yüksekliği (m)	Boyutlar (mm)axbxc	Koli Ağırlığı (kg)	Koli Adedi	Fiyat
314730	Max. 20	4-15	74x32,5x74	6,9	50	37,00\$

Özellikler       

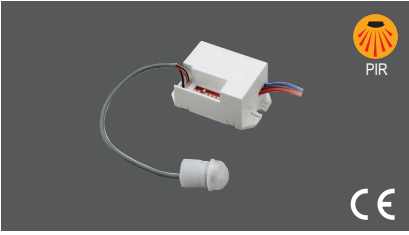

### Mini Hareket Sensörü

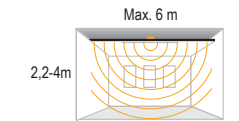

Kod	Algılama Mesafesi (m)	Montaj Yüksekliği (m)	Boyutlar (mm)axbxc	Kesim Ölçüsü (mm)	Koli Ağırlığı (kg)	Koli Adedi	Fiyat
314732	Max. 6	2,2-4	55,4x25,5x36,83	13	-	100	10,45\$

Özellikler      



### Fotosel

Gece gündüz farkını algılayarak dış mekan aydınlatmalarında kontrol sağlar.



Kod	Algılama Mesafesi (m)	Montaj Yüksekliği (m)	Boyutlar (mm)axbxc	Koli Ağırlığı (kg)	Koli Adedi	Fiyat
314738	-	-	63x77	13,6	100	6,35\$

Özellikler  

# Endüstriyel Acil Aydınlatmada Güvenli Çözüm

Zorlu endüstriyel ortamlar için tasarlandı. Güçlü ışık çıktısı ve esnek montaj seçenekleriyle (busbar, kablo tavası, sıva üstü) acil durumlarda maksimum güvenlik sağlar.



LUMINA



Geniş Montaj Seçeneği  
Kablo Tavası, Busbar, Sıva Üstü



Oynar Başlık



Şarj-Deşarj Göstergesi



Anahtar ve Test Butonu



## Emergency Spot

Lumina

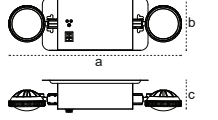

Kod	Güç (W)	Batarya	Şarj Süresi	Deşarj Süresi	Işık Akısı (lm)	Renk Sıcaklığı (K)	Boyutlar (mm)axbxc	Koli Ağırlığı (kg)	Koli Adedi	Fiyat
117564	2x10	6V 4500 mAh	30h	6h	800	4000	576x179x96	-	4	154,50\$

Özellikler	Metal	PC Difüzör	4000K / 6500K	IP40	LED Çip Ömrü 50.000h
	Şarj Göstergesi	Deşarj Göstergesi	Anahtar ve Test Butonu	Taşıyabilir, Asılabilir	



## Metal Emergency Spot

Emera

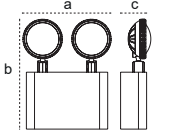

Kod	Güç (W)	Batarya	Şarj Süresi	Deşarj Süresi	Işık Akısı (lm)	Renk Sıcaklığı (K)	Boyutlar (mm)axbxc	Koli Ağırlığı (kg)	Koli Adedi	Fiyat
117445	2x20	2x 6V 4500mAh	30h	6h	1600	4000	325x340x80	12	8	230,00\$

Özellikler	Metal	PMMA Difüzör	4000/6500K	IP40	LED Çip Ömrü 50.000h
	Şarj Göstergesi	Deşarj Göstergesi	Anahtar ve Test Butonu	Taşıyabilir, Asılabilir	



## Metal Emergency Spot

Emera

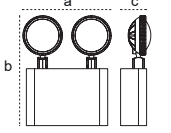

Kod	Güç (W)	Batarya	Şarj Süresi	Deşarj Süresi	Işık Akısı (lm)	Renk Sıcaklığı (K)	Boyutlar (mm)axbxc	Koli Ağırlığı (kg)	Koli Adedi	Fiyat
109780	2x10	6 V 4500 mAh	30h	6h	800	4000	325x340x80	12	4	140,00\$

Özellikler	Metal	PMMA Difüzör	4000/6500K	IP40	LED Çip Ömrü 50.000h
	Şarj Göstergesi	Deşarj Göstergesi	Anahtar ve Test Butonu	Taşıyabilir, Asılabilir	



## Metal Emergency Spot

Emera

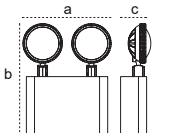

Kod	Güç (W)	Batarya	Şarj Süresi	Deşarj Süresi	Işık Akısı (lm)	Renk Sıcaklığı (K)	Boyutlar (mm)axbxc	Koli Ağırlığı (kg)	Koli Adedi	Fiyat
109781	2x5	6 V 4500 mAh	30h	6h	400	4000	275x340x80	10,8	4	81,00\$

Özellikler	Metal	PMMA Difüzör	4000/6500K	IP40	LED Çip Ömrü 50.000h
	Şarj Göstergesi	Deşarj Göstergesi	Anahtar ve Test Butonu	Taşıyabilir, Asılabilir	



1x10W

## Metal Emergency Spot

Emera

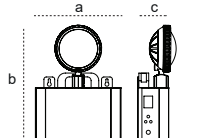

Kod	Güç (W)	Batarya	Şarj Süresi	Deşarj Süresi	Işık Akısı (lm)	Renk Sıcaklığı (K)	Boyutlar (mm)axbxc	Koli Ağırlığı (kg)	Koli Adedi	Fiyat
116863	10	6 V 4500 mAh	30h	6h	400	4000	222x300x80	10,2	6	76,00\$

Özellikler	Metal	PMMA Difüzör	4000/6500K	IP40	LED Çip Ömrü 50.000h
	Şarj Göstergesi	Deşarj Göstergesi	Anahtar ve Test Butonu	Taşıyabilir, Asılabilir	



### Emergency Spot

Spectra



Kod	Güç (W)	Batarya	Şarj Süresi	Deşarj Süresi	Işık Akısı (lm)	Renk Sıcaklığı (K)	Boyutlar (mm)axbxc	Koli Ağırlığı (kg)	Koli Adedi	Fiyat
336610	1,5	3.2V 1.8Ah	24h	4h	160	6500	174x74x63	-	6	Fiyat Sorunuz

Özellikler
<ul style="list-style-type: none"> <li>PC</li> <li>6500K</li> <li>IP65</li> <li>LED Çip Ömrü 50.000 saat</li> <li>On/Off</li> <li>Self Test</li> <li>Manual Test</li> </ul>

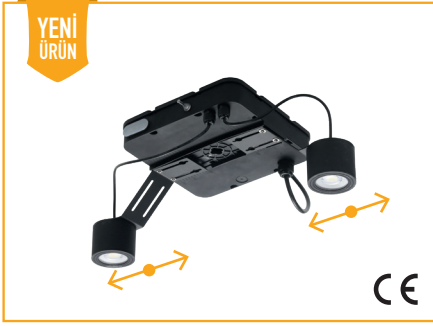

### Emergency Spot

Visera

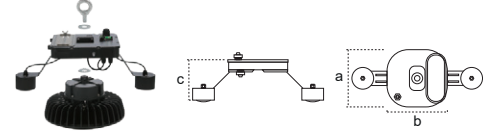

Kod	Güç (W)	Batarya	Şarj Süresi	Deşarj Süresi	Işık Akısı (lm)	Renk Sıcaklığı (K)	Boyutlar (mm)axbxc	Koli Ağırlığı (kg)	Koli Adedi	Fiyat
336611	2x5	6,4V 3,6Ah	24h	3h	400	6500	202x222x143	-	6	Fiyat Sorunuz

Özellikler
<ul style="list-style-type: none"> <li>PC</li> <li>6500K</li> <li>IP65</li> <li>LED Çip Ömrü 50.000 saat</li> <li>On/Off</li> <li>Self Test</li> <li>Manual Test</li> </ul>



### IP65 Emergency Spot

Lumera



Kod	Güç (W)	Batarya	Şarj Süresi	Deşarj Süresi	Işık Akısı (lm)	Renk Sıcaklığı (K)	Boyutlar (mm)axbxc	Koli Ağırlığı (kg)	Koli Adedi	Fiyat
117138	2x10	6V 4500mAh	30h	6h	800	4000	350x245x117	11,3	8	140,00\$

Özellikler
<ul style="list-style-type: none"> <li>Polimer Enjeksiyon</li> <li>PMMA Difüzör</li> <li>3000/4000/6500K</li> <li>IP65</li> <li>LED Çip Ömrü 50.000 saat</li> </ul>



### IP65 Metal Emergency Spot

Emera

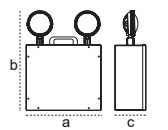

Kod	Güç (W)	Batarya	Şarj Süresi	Deşarj Süresi	Işık Akısı (lm)	Renk Sıcaklığı (K)	Boyutlar (mm)axbxc	Koli Ağırlığı (kg)	Koli Adedi	Fiyat
110679	2x10	6 V 4500 mAh	30h	6h	800	4000	340x480x150	6,7	1	178,00\$

Özellikler
<ul style="list-style-type: none"> <li>Metal</li> <li>PMMA Difüzör</li> <li>4000/6500K</li> <li>IP65</li> <li>LED Çip Ömrü 50.000 saat</li> <li>Şarj Göstergesi</li> <li>Deşarj Göstergesi</li> <li>Anahtar ve Test Butonu</li> <li>Taşınabilir, Asılabilir</li> </ul>

2x10W

CE

### IP65 Acil Aydınlatma Armatürü

Ausled

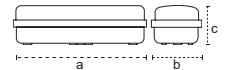

Kod	Tip	Güç (W)	Batarya	Şarj Süresi	Deşarj Süresi	Işık Akısı (lm)	Renk Sıcaklığı (K)	Boyutlar (mm)axbxc	Koli Ağırlığı (kg)	Koli Adedi	Fiyat
115138	AC	10	-	24h	3h	1000	6500	350x117x76	10,4	12	25,50\$
115140	DC	3	3,7V 3500mAh	24h	3h	300	6500	350x117x76	10,4	12	45,70\$
108390	AC/DC	5	3,7V 3500mAh	24h	3h	500	6500	350x117x76	10,4	12	49,00\$
110667	AC/DC	10	3,7V 3500mAh	24h	3h	1000	6500	350x117x76	10,4	12	54,00\$

Özellikler
<ul style="list-style-type: none"> <li>Polimer Enjeksiyon</li> <li>PC Difüzör</li> <li>3000/4000/6500K</li> <li>IP65</li> <li>LED Çip Ömrü 50.000 saat</li> </ul>

Opsiyonlar
<ul style="list-style-type: none"> <li>DALI</li> </ul>



ŞOK FİYAT  
46,50\$

Anahtar ve Test Butonu

Taşınabilir, Asılabilir



Şarj Göstergesi

Deşarj Göstergesi



2x3W

CE

### Emergency Spot

Rotora

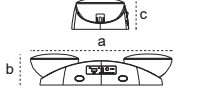

Kod	Güç (W)	Batarya	Şarj Süresi	Deşarj Süresi	Işık Akısı (lm)	Renk Sıcaklığı (K)	Boyutlar (mm)axbxc	Koli Ağırlığı (kg)	Koli Adedi	Fiyat
203911	2x3	4 V 2000 mAh	24h	4h	300	4000	261x89x59	6,4	10	46,50\$

Özellikler

- Plastik
- PMMA Difüzör
- 4000K
- IP40
- LED Çip Ömrü 50.000 saat
- Şarj Göstergesi
- Deşarj Göstergesi
- Anahtar ve Test Butonu
- Taşınabilir, Asılabilir



CE

### Emergency Spot

Rotora

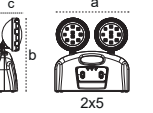

Kod	Güç (W)	Batarya	Şarj Süresi	Deşarj Süresi	Işık Akısı (lm)	Renk Sıcaklığı (K)	Boyutlar (mm)axbxc	Koli Ağırlığı (kg)	Koli Adedi	Fiyat
203913	2x5	4 V 2000 mAh	24h	4h	400	4000	280x279x89	9,5	8	71,50\$

Özellikler

- Polimer Enjeksiyon
- PMMA Difüzör
- 4000K
- IP40
- LED Çip Ömrü 50.000 saat
- Şarj Göstergesi
- Deşarj Göstergesi
- Anahtar Butonu
- Taşınabilir, Asılabilir



CE

### Emergency Spot

Rotora

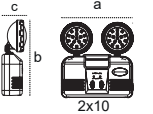

Kod	Güç (W)	Batarya	Şarj Süresi	Deşarj Süresi	Işık Akısı (lm)	Renk Sıcaklığı (K)	Boyutlar (mm)axbxc	Koli Ağırlığı (kg)	Koli Adedi	Fiyat
203907	2x10	6 V 3000 mAh	24h	6h	800	4000	286x299x89	12,7	8	115,00\$

Özellikler

- Polimer Enjeksiyon
- PMMA Difüzör
- 4000K
- IP40
- LED Çip Ömrü 50.000 saat
- Şarj Göstergesi
- Deşarj Göstergesi
- Anahtar Butonu
- Taşınabilir, Asılabilir



CE

### Acil Aydınlatma Armatürü

Alerna

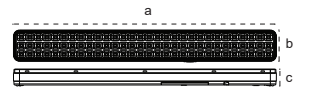

Kod	Tip	Batarya	Şarj Süresi	Deşarj Süresi	Renk Sıcaklığı (K)	Boyutlar (mm)axbxc	Koli Ağırlığı (kg)	Koli Adedi	Fiyat
204619	30 LED	3,7V 1,2Ah Ni-Cd	24h	8h	6500	203x55x29	7,5	40	10,00\$
204620	60 LED	3,7V 2,2Ah Ni-Cd	24h	8h	6500	342x55x29	7,5	24	17,25\$
204623	90 LED	2x3,7V 2,0Ah Ni-Cd	24h	8h	6500	482x55x29	7,5	20	28,00\$
209039	120 LED	2x3,7V 2,2Ah Ni-Cd	24h	8h	6500	482x55x29	7,5	20	37,50\$

Özellikler

- Polimer Enjeksiyon
- Plastik Difüzör
- 6500K
- IP40
- LED Çip Ömrü 30.000 saat
- Şarj Göstergesi
- Deşarj Göstergesi
- Anahtar ve Test Butonu
- Taşınabilir, Asılabilir

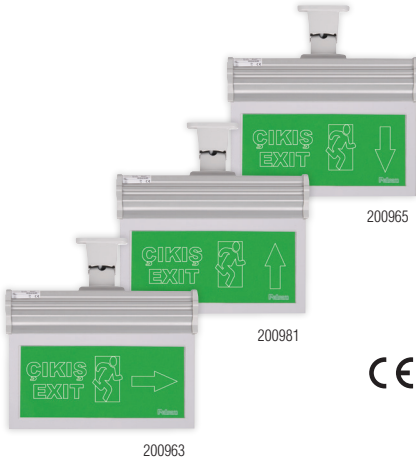

**Vialed (3 saat)**

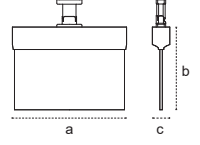

Kod	Tip	Güç (W)	Batarya	Şarj Süresi	Deşarj Süresi	Renk Sıcaklığı (K)	Boyutlar (mm)axbxc	Koli Ağırlığı (kg)	Koli Adedi	Fiyat
200965	Çift Yön	3	1000 mAh 1.2 Ni-Mh	24h	3h	6500	280x205x42	11	10	36,75\$
200981	Çift Yön	3	1000 mAh 1.2 Ni-Mh	24h	3h	6500	280x205x42	11	10	36,75\$
200963	Çift Yön	3	1000 mAh 1.2 Ni-Mh	24h	3h	6500	280x205x42	11	10	36,75\$



Özellikler Alüminyum PMMA Difüzör IP20 50.000h Şarj Göstergesi Deşarj Göstergesi



**Vialed (3 saat)**

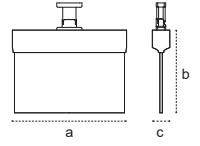

Kod	Tip	Güç (W)	Batarya	Şarj Süresi	Deşarj Süresi	Renk Sıcaklığı (K)	Boyutlar (mm)axbxc	Koli Ağırlığı (kg)	Koli Adedi	Fiyat
200944	Tek Yön	3	1000 mAh 1.2 Ni-Mh	24h	3h	6500	280x205x42	11	10	36,75\$
201013	Çift Yön	3	1000 mAh 1.2 Ni-Mh	24h	3h	6500	280x205x42	11	10	36,75\$
205265	Çift Yön	3	1000 mAh 1.2 Ni-Mh	24h	3h	6500	280x205x42	11	10	36,75\$
200946	Tek Yön	3	1000 mAh 1.2 Ni-Mh	24h	3h	6500	280x205x42	11	10	36,75\$



Özellikler Alüminyum PMMA Difüzör IP20 50.000h Şarj Göstergesi Deşarj Göstergesi



**Exiled (3 saat)**

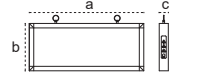

Kod	Tip	Güç (W)	Batarya	Şarj Süresi	Deşarj Süresi	Renk Sıcaklığı (K)	Boyutlar (mm)axbxc	Koli Ağırlığı (kg)	Koli Adedi	Fiyat
203885	Çift Yön	3	800 mAh 1.2 Ni-Cd	24h	3h	6500	360x150x24	6,8	20	12,10\$
203891	Tek Yön	3	800 mAh 1.2 Ni-Cd	24h	3h	6500	360x150x24	6,8	20	12,10\$
203888	Çift Yön	3	800 mAh 1.2 Ni-Cd	24h	3h	6500	360x150x24	6,8	20	12,10\$
203889	Çift Yön	3	800 mAh 1.2 Ni-Cd	24h	3h	6500	360x150x24	6,8	20	12,10\$



Özellikler Alüminyum Seffaf Cam IP20 LED Çip Ömrü 30.000 saat Şarj Göstergesi Deşarj Göstergesi Test Butonu



**Exiled (3 saat)**

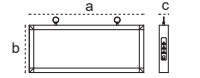

Kod	Tip	Güç (W)	Batarya	Şarj Süresi	Deşarj Süresi	Renk Sıcaklığı (K)	Boyutlar (mm)axbxc	Koli Ağırlığı (kg)	Koli Adedi	Fiyat
203887	Çift Yön	3	800 mAh 1.2 Ni-Cd	24h	3h	6500	360x150x24	6,8	20	12,10\$
203890	Çift Yön	3	800 mAh 1.2 Ni-Cd	24h	3h	6500	360x150x24	6,8	20	12,10\$
205688	Çift Yön	3	800 mAh 1.2 Ni-Cd	24h	3h	6500	450x188x94	11	20	12,10\$



Özellikler Alüminyum Seffaf Cam IP20 LED Çip Ömrü 30.000 saat Şarj Göstergesi Deşarj Göstergesi Test Butonu



**Rausled (3 saat) IP65**

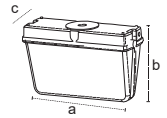

Kod	Tip	Güç (W)	Batarya	Şarj Süresi	Deşarj Süresi	Işık Akısı (lm)	Renk Sıcaklığı (K)	Etkinlik Faktörü (lm/W)	Boyutlar (mm)axbxc	Koli Ağırlığı (kg)	Koli Adedi	Fiyat
113621	Sıva Üstü	5	3,7V 3500mAh	24h	3h	500	6500	100	350x117x218	5,5	6	61,00\$



Özellikler Polimer Enjeksiyon PC Difüzör 3000/4000/6500K IP65 LED Çip Ömrü 50.000 saat



Opsiyonlar DALI



## Ekonomik Çözüm RutaLED

 PVC Gövde

 Tek ve Çift Yön  
Kullanım Opsiyonu

 Sıva Altı, Sıva Üstü,  
Sarkıt Montaj Opsiyonu

RutaLED

Sıva Üstü

Sarkıt

Sıva Altı

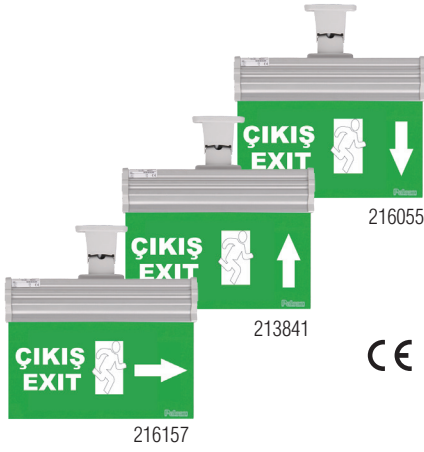

CE

### RutaLED

Kod	Tip	Güç (W)	Batarya	Şarj Süresi	Deşarj Süresi	Renk Sıcaklığı (K)	Boyutlar (mm)axbxc	Koli Ağırlığı (kg)	Koli Adedi	Fiyat
212216	Çift Yön	3	1000 mAh 1.2 Ni-Mh	24h	3h	6500	280x205x42	7	10	28,00\$
213841	Çift Yön	3	1000 mAh 1.2 Ni-Mh	24h	3h	6500	280x205x42	7	10	28,00\$
216157	Çift Yön	3	1000 mAh 1.2 Ni-Mh	24h	3h	6500	280x205x42	11	10	28,00\$

Özellikler

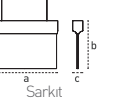
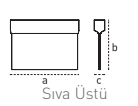
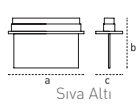

CE

### RutaLED

Kod	Tip	Güç (W)	Batarya	Şarj Süresi	Deşarj Süresi	Renk Sıcaklığı (K)	Boyutlar (mm)axbxc	Koli Ağırlığı (kg)	Koli Adedi	Fiyat
212064	Çift Yön	3	1000 mAh 1.2 Ni-Mh	24h	3h	6500	280x205x42	7	10	28,00\$
212220	Çift Yön	3	1000 mAh 1.2 Ni-Mh	24h	3h	6500	280x205x42	7	10	28,00\$
212221	Çift Yön	3	1000 mAh 1.2 Ni-Mh	24h	3h	6500	280x205x42	11	10	28,00\$

Özellikler

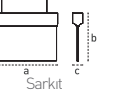
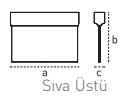
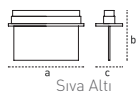

# 13

CİHAZA  
KADAR  
BESLEME İMKANI



LED EKLAN



LED İŞILDAK



KABLOSUZ ŞARJ

2 SAATTE  
HIZLI ŞARJ3 FARKLI  
ŞARJ YÖNTEMİ

## Voltiron

Taşınabilir Güç Kaynağı

Kod	Güç (W)	Koli Adedi	Fiyat
209726	1000	1	1.229,00\$

### Inovaled G3

Temperli Cam Alüminyum Etanj



5 YIL GARANTİ

TSE Belgesi

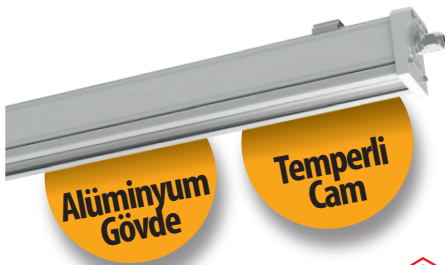

### Inovaled G3 IP66

Temperli Cam Alüminyum Etanj

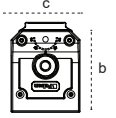

Kod	Güç (W)	Renk Sıcaklığı (K)	Işık Akısı (lm)	Etkinlik Faktörü (lm/W)	Boyutlar (mm)axbxc	Koli Ağırlığı (kg)	Koli Adedi	Fiyat
116583	19	6500	2033	107	630x82x63	8,6	6	61,50\$
116584	26	6500	2782	107	910x82x63	10,7	6	94,55\$
116585	34	6500	3672	108	1190x82x63	14,7	6	113,80\$

<b>Özellikler</b>	Alüminyum	Temperli Cam	3000/4000/6500K	IP66	LED Çip Ömrü L70 Tc@105°C > 102.000h.	LED Sürücü Ömrü L70 Tc@65°C > 120.000	5 Yıl
<b>Opsiyonlar</b>	DALI	1-10V	Acil Aydınlatma (1-3 saat)				

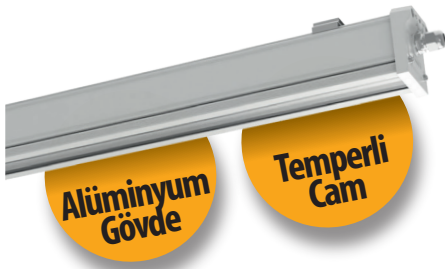

### Inovaled Max IP66

Temperli Cam Alüminyum Etanj

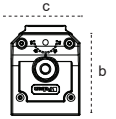

Kod	Güç (W)	Renk Sıcaklığı (K)	Işık Akısı (lm)	Etkinlik Faktörü (lm/W)	Boyutlar (mm)axbxc	Koli Ağırlığı (kg)	Koli Adedi	Fiyat	
118300	50	6500	5400	108	910x82x62	10,4	6	99,00\$	
118299	75	6500	8250	110	910x82x62	10,4	6	104,00\$	
116580	100	6500	12300	123	910x82x62	10,7	6	116,25\$	
116581	120	6500	15000	125	1190x82x62	14,7	6	141,50\$	
116582	150	6500	18750	125	1470x82x62	19,7	6	154,25\$	
326217	Açı ayarlı montaj aparatı (2'li)							1	3,50\$

<b>Özellikler</b>	Alüminyum	Temperli Cam	3000/4000/6500K	IP66	LED Çip Ömrü L70 Tc@105°C > 102.000h.	LED Sürücü Ömrü L70 Tc@65°C > 120.000	5 Yıl
<b>Opsiyonlar</b>	DALI	Acil Aydınlatma (1-3 saat)	Busbar				



### Prota G3

Alüminyum Etanj

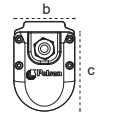

Kod	Güç (W)	Renk Sıcaklığı (K)	Işık Akısı (lm)	Etkinlik Faktörü (lm/W)	Boyutlar (mm)axbxc	Koli Ağırlığı (kg)	Koli Adedi	Fiyat
115014	18	6500	2250	125	555x64x46	7	12	34,65\$
115016	23	6500	2921	127	805x64x46	9,5	12	43,70\$
115018	33	6500	4125	125	1055x64x46	11,5	12	54,40\$
115020	43	6500	5504	128	1305x64x46	14	12	63,50\$

<b>Özellikler</b>	Alüminyum	Opal Difüzör	3000/4000/6500K	IP65	LED Çip Ömrü L70 Tc@105°C > 102.000h.	LED Sürücü Ömrü Tc@65°C 50.000h.	5 Yıl
<b>Opsiyonlar</b>	DALI	1-10V	Acil Aydınlatma (1-3 saat)				



↓ 11 Ayda Kendini Amorti Eder

Largo Optima  
Etanj Armatür

%45 Daha Az Enerji Tüketimi ile  
Yatırımın En Karlısı

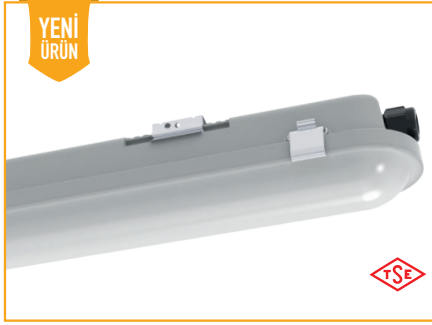
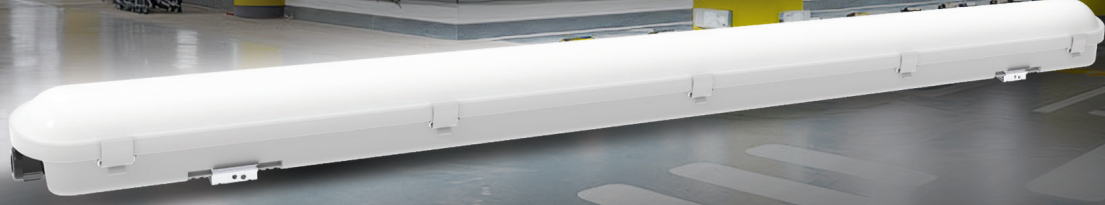

### Largo Optima Etanj

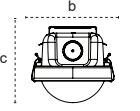

Kod	Güç (W)	Renk Sıcaklığı (K)	Işık Akısı (lm)	Etkinlik Faktörü (lm/W)	Boyutlar (mm)axbxc	Koli Ağırlığı (kg)	Koli Adedi	Fiyat
118194	34	6500	4420	130	1150x80x75	14,7	9	54,80\$

<b>Özellikler</b>	PC	PC Difüzör	3000/4000/6500K	IP65	LED Çip Ömrü L70 Tc@105°C >102.000h.	LED Sürecü Ömrü Tc@65°C 50.000h.	5 Yıl
<b>Opsiyonlar</b>	Busbar	Sarkit					



### Largo G2 Etanj

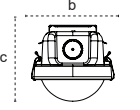

Kod	Güç (W)	Renk Sıcaklığı (K)	Işık Akısı (lm)	Etkinlik Faktörü (lm/W)	Boyutlar (mm)axbxc	Koli Ağırlığı (kg)	Koli Adedi	Fiyat
115957	14	6500	1862	133	610x80x75	11,7	9	29,00\$
115787	20	6500	2640	132	610x80x75	11,7	9	29,00\$
115963	27	6500	3159	117	610x80x75	11,7	9	31,50\$
116061	26	6500	3458	133	1150x80x75	22	9	34,50\$
116062	34	6500	4420	130	1150x80x75	22	9	34,50\$
116063	50	6500	6500	130	1150x80x75	22	9	64,50\$
116064	75	6500	8550	114	1150x80x75	22	9	83,50\$
116066	75	6500	8850	118	1500x80x75	27,9	9	90,00\$
116067	100	6500	11200	112	1500x80x75	27,9	9	97,40\$

<b>Özellikler</b>	PC	PC Difüzör	3000/4000/6500K	IP65	LED Çip Ömrü L70 Tc@105°C >102.000h.	LED Sürecü Ömrü Tc@65°C 50.000h.	5 Yıl
<b>Opsiyonlar</b>	DALI	Acil Aydınlatma (1-3 saat)	Radar Sensör	Busbar	Sarkit		



### Largo G2 Max

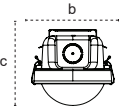

Kod	Güç (W)	Renk Sıcaklığı (K)	Işık Akısı (lm)	Etkinlik Faktörü (lm/W)	Boyutlar (mm)axbxc	Koli Ağırlığı (kg)	Koli Adedi	Fiyat
116066	75	6500	8850	118	1500x80x75	27,9	9	90,00\$
116067	100	6500	11200	112	1500x80x75	27,9	9	97,40\$

<b>Özellikler</b>	PC	Opal Difüzör	3000/4000/6500K	IP65	LED Çip Ömrü L70 Tc@105°C >102.000h.	LED Sürecü Ömrü Tc@65°C 50.000h.	5 Yıl
<b>Opsiyonlar</b>	DALI	Acil Aydınlatma (1-3 saat)	Radar Sensör	Busbar			

Rigo

**Ekonomik Çözüm**  
**Rigo**

**ŞOK FİYAT**  
**26,10\$**



**Rigo**  
Etanj

Kod	Güç (W)	Renk Sıcaklığı (K)	Işık Akısı (lm)	Etkinlik Faktörü (lm/W)	Boyutlar (mm)axbxc	Koli Ağırlığı (kg)	Koli Adedi	Fiyat
117147	20	6500	2400	120	650x72x50	5,4	12	25,00\$
117145	36	6500	4392	122	1250x72x50	9,6	12	26,10\$

Özellikler	PC	Opal Difüzör	3000/4000/6500K	IP65	LED Çip Ömrü L70 Tc@105°C >102.000h.	LED Sürücü Ömrü Tc@65°C 50.000h.	2 Yıl
Opsiyonlar	Acil Aydınlatma (1-3 saat)						

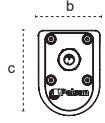

**Rigo Max**  
Etanj

Kod	Güç (W)	Renk Sıcaklığı (K)	Işık Akısı (lm)	Etkinlik Faktörü (lm/W)	Boyutlar (mm)axbxc	Koli Ağırlığı (kg)	Koli Adedi	Fiyat
117702	50	6500	5500	110	1500x72x50	10,5	12	51,75\$
117703	75	6500	8025	107	1500x72x50	10,5	12	57,50\$

Özellikler	PC	Opal Difüzör	3000/4000/6500K	IP65	LED Çip Ömrü L70 Tc@105°C >102.000h.	LED Sürücü Ömrü Tc@65°C 50.000h.	2 Yıl
Opsiyonlar	Acil Aydınlatma (1-3 saat)						

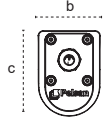

**Tekli Düy**

**Largo**  
LED Tube Etanj x1

Kod	Düy	Renk Sıcaklığı (K)	Işık Akısı (lm)	Etkinlik Faktörü (lm/W)	Boyutlar (mm)axbxc	Koli Ağırlığı (kg)	Koli Adedi	Fiyat
102669	G13	-	-	-	663x85x85	11	6	17,25\$
102713	G13	-	-	-	1273x85x85	17	6	23,20\$
102867	G13	-	-	-	1573x85x85	21,5	6	40,70\$

Özellikler	GRP	Seffaf Difüzör	IP65
Opsiyonlar	Acil Aydınlatma (1 saat)	Busbar	

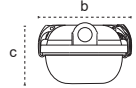

**Çiftli Düy**

**Largo**  
LED Tube Etanj x2

Kod	Düy	Renk Sıcaklığı (K)	Işık Akısı (lm)	Etkinlik Faktörü (lm/W)	Boyutlar (mm)axbxc	Koli Ağırlığı (kg)	Koli Adedi	Fiyat
102687	2xG13	-	-	-	663x85x125	12,8	6	18,00\$
102744	2xG13	-	-	-	1273x85x125	18,5	6	24,40\$

Özellikler	GRP	Seffaf Difüzör	IP65
Opsiyonlar	Acil Aydınlatma (1 saat)	Busbar	

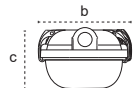



110 Vac

### 110Vac Ria Med G2 Projektör

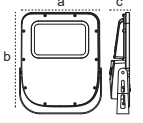

Kod	Güç (W)	Renk Sıcaklığı (K)	Işık Akısı (lm)	Etkinlik Faktörü (lm/W)	Boyutlar (mm)axbxc	Koli Ağırlığı (kg)	Koli Adedi	Fiyat
111788	60	6500	8820	147	340x274x66	15,05	4	126,00\$
111785	80	6500	11360	142	340x274x66	15,05	4	160,00\$
111660	100	6500	13400	134	340x274x66	15,05	4	160,00\$
111666	150	6500	20700	138	340x274x66	15,05	4	187,00\$
116136	200	6500	27600	138	340x274x66	15,05	4	300,00\$



Özellikler



Alüminyum



Temperli Cam



3000/4000/6500K



IP66



LED Çip Ömrü

L70 Tc@105°C >102.000h.



LED Sürücü Ömrü

Tc@65°C 120.000h

Opsiyonlar



30°/60°/90°/Asimetrik\*

\*Asimetrik Lens 50-150W arasında bulunmaktadır.



110 Vac

### 110Vac Doka G2 Yol ve Cadde Armatürü

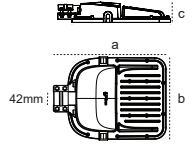

Kod	Güç (W)	Renk Sıcaklığı (K)	Işık Akısı (lm)	Etkinlik Faktörü (lm/W)	Boyutlar (mm)axbxc	Konsol	Koli Ağırlığı (kg)	Koli Adedi	Fiyat
115410	60	4000	8820	147	362x268x65x316	42-60	11,8	4	151,00\$
115412	80	4000	11360	142	362x268x65x316	42-60	11,8	4	165,00\$
115414	100	4000	13800	138	362x268x65x316	42-60	11,8	4	165,00\$
115416	150	4000	19050	127	362x268x65x316	42-60	11,8	4	215,00\$
116241	200	4000	26000	130	362x268x65x316	42-60	11,8	4	330,00\$



Özellikler



Alüminyum



Temperli Cam



3000/4000/6500K



IP66



LED Çip Ömrü

L70 Tc@105°C >102.000h.



LED Sürücü Ömrü

Tc@65°C 120.000h



24 Vac/dc

### 24Vac/dc Trada Linear Armatür

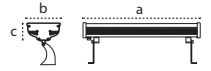

Kod	Güç (W)	Renk Sıcaklığı (K)	Işık Akısı (lm)	Etkinlik Faktörü (lm/W)	Boyutlar (mm)axbxc	Koli Ağırlığı (kg)	Koli Adedi	Fiyat
209187	8	6500	728	91	185x56x87	0,46	1	51,30\$
209190	11	6500	1100	100	270x56x87	0,75	1	58,70\$
209193	24	6500	2328	97	495x56x87	1,02	1	87,20\$



Özellikler



Alüminyum



Temperli Cam



3000/4000/6500K



IP67



50.000h



24 Vac/dc

### 24Vac/dc Trada Projektör

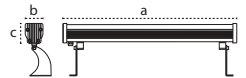

Kod	Güç (W)	Renk Sıcaklığı (K)	Işık Akısı (lm)	Etkinlik Faktörü (lm/W)	Boyutlar (mm)axbxc	Koli Ağırlığı (kg)	Koli Adedi	Fiyat
209183	24	6500	2328	97	205x155x100	1,35	1	127,30\$
209184	38	6500	3724	98	369x155x100	2,24	1	190,30\$



Özellikler



Alüminyum



Temperli Cam



3000/4000/6500K



IP67



50.000h



### Lenta

IP65 Kanopi Armatür



Sıva Üstü Farkı  
**19.00 \$**

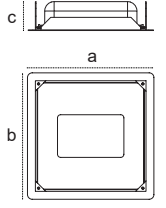

Kod	Güç (W)	Renk Sıcaklığı (K)	Işık Akısı (lm)	Etkinlik Faktörü (lm/W)	Boyutlar (mm)axbxc	Koli Ağırlığı (kg)	Koli Adedi	Fiyat
110507	100	5000	10000	100	400x400x88	5,2	1	<b>129,00\$</b>
116325	150	5000	19500	130	400x400x88	5,2	1	<b>149,00\$</b>

Özellikler → Alüminyum Temperli Cam 5000K IP65 30.000h



### Okta

IP65 Kanopi Armatür

Lens Farkı  
**28.00 \$**

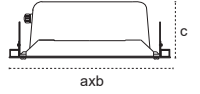

Kod	Güç (W)	Renk Sıcaklığı (K)	Işık Akısı (lm)	Etkinlik Faktörü (lm/W)	Boyutlar (mm)axbxc	Koli Ağırlığı (kg)	Koli Adedi	Fiyat
106627	80	6500	12000	150	400x400x100	4,8	1	<b>180,00\$</b>
110173	100	6500	14000	140	400x400x100	4,8	1	<b>224,00\$</b>

Özellikler → Alüminyum Temperli Cam 3000/4000/6500K IP65 50.000h

Opsiyonlar → DALI Acil Aydınlatma (1-3 saat)

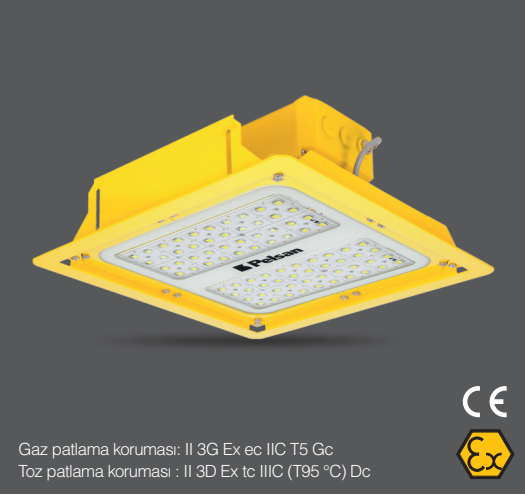

Gaz patlama koruması: II 3G Ex ec IIC T5 Gc  
Toz patlama koruması: II 3D Ex tc IIIC (T95 °C) Dc

### Piriliz Ex-Proof

IP66 Kanopi Armatür

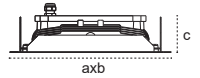

Kod	Güç (W)	Renk Sıcaklığı (K)	Işık Akısı (lm)	Etkinlik Faktörü (lm/W)	Boyutlar (mm)axbxc	Koli Ağırlığı (kg)	Koli Adedi	Fiyat
111376	50	6500	8650	173	395x385x132	8	1	<b>398,00\$</b>
111375	75	6500	12225	163	395x385x132	8	1	<b>450,00\$</b>
111374	100	6500	15700	157	395x385x132	8	1	<b>502,00\$</b>
111382	125	6500	20000	160	395x385x132	8	1	<b>553,00\$</b>
111373	150	6500	22050	147	395x385x132	8	1	<b>604,00\$</b>
111056	200	6500	29600	148	395x385x132	8	1	<b>667,00\$</b>

Özellikler → Alüminyum Temperli Cam 3000/4000/6500K IP66 LED Çip Ömrü L70 Tc@105°C >102.000h LED Sürücü Ömrü Tc@65°C 120.000h

Opsiyonlar → DALI 30° / 60° / 90°



# Pelsan

ETNA,  
Yenilenen G3 Serisi ile

**Şimdi 170lm/W**

170 lm/W

-40 / +70

10kV  
Dahili Parafudr

120000h  
Sürücü Ömrü

IP65  
Toz ve Su Almaz

90-305Vac

DALI

1-10V

Radar Sensör

## Etna G3

### CS Serisi

- Tasarruflu
- Hızlı Amortisman
- Endüstriyel Tesis

### HEC Serisi

- +70°C'ye Kadar Yüksek Performans
- Ağır Sanayi Tesisleri
- 7/24 Çalışma
- Dayanıklı Gövde

### HLO Serisi

- Enerji Verimliliği
- Sürdürülebilirlik
- Verimlilik

### FF Serisi

- Gıda Tesisleri
- Yüksek Güvenlik
- Temperli Filmlerli Cam



**Etna G3L**

Kod	Tip	Güç (W)	Renk Sıcaklığı (K)	Işık Akısı (lm)	Etkinlik Faktörü (lm/W)	Boyutlar (mm)axbxc	Koli Ağırlığı (kg)	Koli Adedi	Fiyat
116898	90°	75	5700	12150	162	440x163x141	3	1	164,00\$
116902	90°	100	5700	16500	165	640x163x141	4	1	191,00\$
116901	90°	125	5700	20000	160	840x163x141	4,9	1	267,00\$
116900	90°	150	5700	24300	162	840x163x141	4,9	1	267,00\$
116899	90°	200	5700	32200	161	1040x163x141	5,6	1	395,00\$

<b>Özellikler</b>	Alüminyum	Temperli Cam	4000/5700/6500K	IP65	LED Çip Ömrü L70 Tc@105°C >102.000h.	LED Sürecü Ömrü Tc@60°C 120.000h
<b>Opsiyonlar</b>	DALI	1-10V	Acil Aydınlatma (1-3 saat)	Radar Sensör	Busbar	5 Yıl



**Etna G3L HLO**

Kod	Tip	Güç (W)	Renk Sıcaklığı (K)	Işık Akısı (lm)	Etkinlik Faktörü (lm/W)	Boyutlar (mm)axbxc	Koli Ağırlığı (kg)	Koli Adedi	Fiyat
116904	90°	50	5700	8300	166	440x163x141	3	1	189,00\$
116903	90°	75	5700	12750	170	640x163x141	4	1	247,00\$
116906	90°	100	5700	16600	166	840x163x141	4,9	1	292,00\$
116905	90°	150	5700	24750	165	1040x163x141	5,6	1	338,00\$

<b>Özellikler</b>	Alüminyum	Temperli Cam	4000/5700/6500K	IP65	LED Çip Ömrü L70 Tc@105°C >102.000h.	LED Sürecü Ömrü Tc@60°C 120.000h
<b>Opsiyonlar</b>	DALI	1-10V	Acil Aydınlatma (1-3 saat)	Radar Sensör	Busbar	5 Yıl



**Etna G3L HEC**

Kod	Tip	Güç (W)	Renk Sıcaklığı (K)	Işık Akısı (lm)	Etkinlik Faktörü (lm/W)	Boyutlar (mm)axbxc	Koli Ağırlığı (kg)	Koli Adedi	Fiyat
116937	90°	50	5700	8300	166	440x163x141	3	1	189,00\$
116938	90°	75	5700	12750	170	640x163x141	4	1	247,00\$
116939	90°	100	5700	16600	166	840x163x141	4,9	1	292,00\$
116940	90°	150	5700	24750	165	1040x163x141	5,6	1	338,00\$

<b>Özellikler</b>	Alüminyum	Temperli Cam	4000/5700/6500K	IP65	LED Çip Ömrü L70 Tc@105°C >102.000h.	LED Sürecü Ömrü Tc@60°C 90.000h
<b>Opsiyonlar</b>	DALI	1-10V	Acil Aydınlatma (1-3 saat)	Radar Sensör	Busbar	5 Yıl



**Etna G3L FF**

Kod	Tip	Güç (W)	Renk Sıcaklığı (K)	Işık Akısı (lm)	Etkinlik Faktörü (lm/W)	Boyutlar (mm)axbxc	Koli Ağırlığı (kg)	Koli Adedi	Fiyat
116907	90°	75	5700	12150	162	440x163x141	3	1	215,00\$
116911	90°	100	5700	16500	165	640x163x141	4	1	242,00\$
116910	90°	125	5700	20000	160	840x163x141	4,9	1	318,00\$
116909	90°	150	5700	24300	162	840x163x141	4,9	1	318,00\$
116908	90°	200	5700	32200	161	1040x163x141	5,6	1	446,00\$

<b>Özellikler</b>	Alüminyum	Filmli Temperli Cam	4000/5700/6500K	IP65	LED Çip Ömrü L70 Tc@105°C >102.000h.	LED Sürecü Ömrü Tc@60°C 120.000h
<b>Opsiyonlar</b>	DALI	1-10V	Acil Aydınlatma (1-3 saat)	Radar Sensör	Busbar	5 Yıl



**Etna G3L CS**

Kod	Tip	Güç (W)	Renk Sıcaklığı (K)	Işık Akısı (lm)	Etkinlik Faktörü (lm/W)	Boyutlar (mm)axbxc	Koli Ağırlığı (kg)	Koli Adedi	Fiyat
116915	90°	100	5700	15700	157	440x163x141	3	1	168,00\$
116914	90°	150	5700	23850	159	640x163x141	4	1	235,00\$
116913	90°	200	5700	31400	157	840x163x141	4,9	1	352,00\$
116912	90°	240	5700	37200	155	1040x163x141	5,6	1	414,00\$

<b>Özellikler</b>	Alüminyum	Temperli Cam	4000/5700/6500K	IP65	LED Çip Ömrü L70 Tc@105°C >102.000h.	LED Sürecü Ömrü Tc@60°C 120.000h
<b>Opsiyonlar</b>	DALI	1-10V	Acil Aydınlatma (1-3 saat)	Radar Sensör	Busbar	5 Yıl

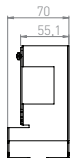

Busbar Aparatı 316387

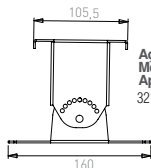

Açı Ayarlı Montaj Aparatı 321804

Kod	Özellikler	Koli Adedi	Fiyat
316387	Etna G2/ Hima G2/ Karpat G3 Busbar Askı Takımı	1	7.30\$
321804	Etna G2/ Hima G2/ Karpat G3 Açı Ayarlı Bağlantı Takımı	1	10.30\$



## Hızlı Amortisman Uzun Süreli Performans

Alüminyum  
Gövde

140lm/W'a  
Varan Verimlilik

IP65 Toz ve  
Su Almaz

100.000h  
Driver Ömrü

+  
DALI, Kit,  
Sensör  
Opsiyonu

5  
YIL  
GARANTİ

TSE  
TSE Belgesi

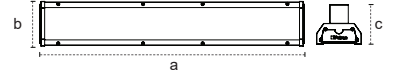

### Hima G3

Kod	Güç (W)	Renk Sıcaklığı (K)	Işık Akısı (lm)	Etkinlik Faktörü (lm/W)	Boyutlar (mm)axbxc	Koli Ağırlığı (kg)	Koli Adedi	Fiyat
116807	75	6500	10500	140	585x146x130	4,5	1	97,00\$
116808	110	6500	15400	140	865x146x130	4,5	1	128,00\$
116809	150	6500	21000	140	1145x146x130	6	1	153,00\$

Özellikler	Alüminyum	Alüminyum Reflektör	Temperli Cam	4000/5700/6500K	IP65	LED Çip Ömrü L70 Tc@85°C >80.000h	LED Süreci Ömrü Tc@60°C >100.000h
Opsiyonlar	DALI	1-10V	Acil Aydınlatma (1-3 saat)	Radar Sensör	Busbar		

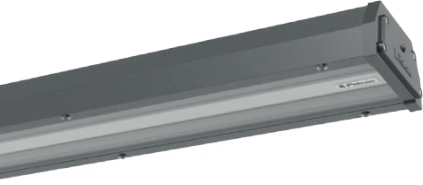

TSE

### Karpat G4

Kod	Güç (W)	Renk Sıcaklığı (K)	Işık Akısı (lm)	Etkinlik Faktörü (lm/W)	Boyutlar (mm)axbxc	Koli Ağırlığı (kg)	Koli Adedi	Fiyat
117102	75	6500	9150	122	600x110x60	4,4	2	61,75\$
117127	110	6500	13860	126	880x110x60	6,5	2	84,00\$
117124	140	6500	17500	125	1160x110x60	8	2	117,50\$
116489	180	6500	22320	124	882x207x65	5,5	1	221,00\$

Özellikler	Metal / Alüminyum	Temperli Cam	3000/4000/6500K	IP65	LED Çip Ömrü L70 Tc@85°C >80.000h	LED Süreci Ömrü Tc@65°C >50.000h
Opsiyonlar	DALI	1-10V	Acil Aydınlatma (1-3 saat)	Busbar		



TSE



YENİ  
ÜRÜN

### Emergency Spot Lumina

Kod	Güç (W)	Batarya	Şarj Süresi	Deşarj Süresi	Işık Akısı (lm)	Renk Sıcaklığı (K)	Boyutlar (mm)axbxc	Koli Ağırlığı (kg)	Koli Adedi	Fiyat
117564	2x10	6V 4500 mAh	30h	6h	800	4000	576x179x96	-	4	154,50\$

Özellikler	Metal	PC Difüzör	4000K / 6500K	IP40	LED Çip Ömrü 50.000h
	Şarj Göstergesi	Deşarj Göstergesi	Anahtar ve Testi Butonu	Taahhütlü, Asilabilir	

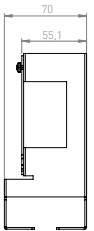

Busbar Aparatı  
316387

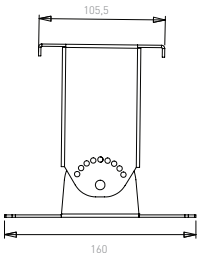

Açık Ayarlı Montaj Aparatı  
321804

Kod	Özellikler	Koli Adedi	Fiyat
316387	Etna G2/ Hima G2/ Karpat G3 Busbar Askı Takımı	1	7.30\$
321804	Etna G2/ Hima G2/ Karpat G3 Açık Ayarlı Bağlantı Takımı	1	10.30\$

### Casto CS Yüksek Tavan Armatürü

160 lm/W'a  
Varan Verimlilik

120.000 saat  
Driver Ömrü

IP65 Toz ve  
Su Almaz

ENEC  
Belgeli Driver

-40°C +55°C  
Çalışma Sıcaklığı

6kV Dahili  
Parafudr

3 Boyda 9 Farklı  
Güç Seçeneği

### Castor CS 100W

3 Kademeli  
Güç Ayarı

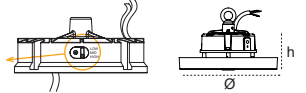

Kod	Güç (W)	Renk Sıcaklığı (K)	Işık Akısı (lm)	Etkinlik Faktörü (lm/W)	Boyutlar (mm)Øxh	Koli Ağırlığı (kg)	Koli Adedi	Fiyat
116959	100	5700	15700	157	230x146	2,1	6	124,00\$
<b>Özellikler</b>	Alüminyum	PC Difüzör	5700K	IP65	LED Çip Ömrü L70 Tc@105°C >102.000h.	LED Sürecü Ömrü Tc@60°C 120.000h	5 Yıl	
<b>Opsiyonlar</b>	DALI	1-10V	Acil Aydınlatma (1-3 saat)	Radarsensör	Sarkit			

### Castor CS 150W

3 Kademeli  
Güç Ayarı

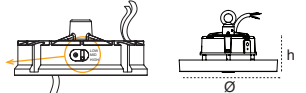

Kod	Güç (W)	Renk Sıcaklığı (K)	Işık Akısı (lm)	Etkinlik Faktörü (lm/W)	Boyutlar (mm)Øxh	Koli Ağırlığı (kg)	Koli Adedi	Fiyat
116960	150	5700	24000	160	270x146	2,5	4	133,00\$
<b>Özellikler</b>	Alüminyum	PC Difüzör	5700K	IP65	LED Çip Ömrü L70 Tc@105°C >102.000h.	LED Sürecü Ömrü Tc@60°C 120.000h	5 Yıl	
<b>Opsiyonlar</b>	DALI	1-10V	Acil Aydınlatma (1-3 saat)	Radarsensör	Sarkit			

### Castor CS 200W

3 Kademeli  
Güç Ayarı

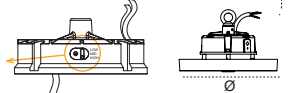

Kod	Güç (W)	Renk Sıcaklığı (K)	Işık Akısı (lm)	Etkinlik Faktörü (lm/W)	Boyutlar (mm)Øxh	Koli Ağırlığı (kg)	Koli Adedi	Fiyat
116961	200	5700	32000	160	310x146	3,2	4	141,00\$
<b>Özellikler</b>	Alüminyum	PC Difüzör	5700K	IP65	LED Çip Ömrü L70 Tc@105°C >102.000h.	LED Sürecü Ömrü Tc@60°C 120.000h	5 Yıl	
<b>Opsiyonlar</b>	DALI	1-10V	Acil Aydınlatma (1-3 saat)	Radarsensör	Sarkit			

Kod	Özellikler	Koli Adedi	Fiyat
325718	Castor CS Busbar Askı Takımı	1	3,90\$
325458	Castor CS Kamaşma Ünleyici Reflektör	1	19,90\$





# Ex-Proof Üretiminde Kalitemiz Tescillendi

**IEP** ENERGY PETROLEUM INSTITUTE

**IEP ATEX**

(1) **ÜRETİM KALİTE GÜVENCE BİLDİRİMİ**

(2) **Potansiyel Patlayıcı Atmosferde Kullanılan Ekipmanlar ve Koruyucu Sistemler**  
2014/34/AB Direktifi

(3) Bildirim Sertifika Numarası: IEP 25 ATEX Q 1793

(4) Bu bildirim, bu bildirimle ilişkilendirilen Ekte listelenen Sertifikalarda açıklanan ekipman veya koruyucu sistemler veya bileşenler için düzenlenmiştir.

(5) Üretici firma: **PELSAN AYDINLATMA SANAYİ TİCARET ANONİM ŞİRKETİ**  
Bankalar Cad. Emekyemez Mah. Yankıkapı Proşuk Sok. No:11 Karaköy  
İstanbul – TÜRKİYE

(6) Üretim Yeri: **Çerkeşli OSB İmes 5 Cad. 400 Ada 6 Parsel No:12**  
Dilovası / Kocaeli – TÜRKİYE

(7) 2014/34/EU yönetmeliğinin 19. Maddesi uyarınca VII için 2284 onaylanmış kuruluş numarasına sahip IEP Uluslararası Enerji Petrol Gözetim, Sertifikasyon ve Teknik Hizmetler Organizasyonu Tic. Ltd. Şti. başvuru sahibi üretici firmanın yönetmeliğinin EK VII maddesini sağlayan ürünün son teçhizat muayenesi ve testi için bir üretim kalite sistemine sahip olduğunu onaylar.

(8) Bu bildirim 26.12.2025 tarihli IEP-RP-Ex-10.3569 numaralı denetim raporuna dayanmaktadır. Üretim sürecinin periyodik gözetimi bu bildirim bir parçasıdır.

(9) Bu Bildirim 28/12/2028 tarihine kadar geçerlidir ve imalatçının Ek VII'nin gerekliliklerini artık karşılayamaması durumunda geri çekilebilir.

(10) 2014/34/EU sayılı Direktif Madde 16 [3] uyarınca CE İşaretini, üretim kontrol aşamasında yer alan onaylanmış kuruluş olarak IEP' nin 2284 kimlik numarası takip etmelidir.

(11) Bu Bildirim yalnızca bütünüyle ve herhangi bir değişiklik yapılmadan, program dahil olmak üzere çoğaltılabilir.

Yetkili Kişi :  
Nurettin Terzioğlu  
Belgelendirme Müdürü

Veriliş tarihi : 29.12.2025

**IEP ATEX**  
2284

IEP Uluslararası Enerji Petrol Göz. Sertifikasyon ve Teknik Hiz. Org. Tic. Ltd. Şti.  
Meriç Mah. 5746/1 Sok. No:2/2 Homova - İzmir / TÜRKİYE  
Tel : +90 232 431 17 45 (pbx) e-mail: kep@iep.com.tr  
Bu sertifika IEP Enerji Petrol Enstitüsünün genel kullanimına tabidir. Bu sertifika sadece bütün  
halinde bir belgenin ayrı olarak kullanilamaz, çoğaltilamaz ve herhangi bir  
değişiklik yapılmaz. Bu belgenin doğruluğunu www.iep.com.tr adresinden kontrol  
edebilirsiniz.

Sayfa | 1 / 2



**QAN, ATEX direktiflerine uygun üretim yapılabildiğini gösteren zorunlu bir kalite güvence belgesidir. Bu belge, üretim süreçlerinin yetkili kuruluşlar tarafından denetlendiğini ve Ex-proof ürünlerin uluslararası güvenlik standartlarına uygun şekilde üretildiğini doğrular.**



# Zone1, Zone21 ATEX Belgeli Ex-Proof Armatürler

**Pelsan**

● Gaz Patlama Koruması: Zone 1 ● Toz Patlama Koruması: Zone 21



ZONE 1  
ZONE 21  
II 2G Ex db IIB T6 Gb  
II 2D Ex tb IIIC (T85°C) Db



## Exta Ex-Proof Etanj Armatür

Kod	Güç (W)	Renk Sıcaklığı (K)	Işık Akısı (lm)	Etkinlik Faktörü (lm/W)	Boyutlar (mm)axbxc	Koli Ağırlığı (kg)	Koli Adedi	Fiyat
115871	14	6500	2030	145	471x182x168	3,8	1	525,00\$
115872	26	6500	3692	142	760x182x168	6,5	1	575,00\$
115490	35	6500	5250	150	1320x182x168	10,5	1	645,00\$
115873	50	6500	6800	136	1320x182x168	10,5	1	645,00\$

<b>Özellikler</b>	Alüminyum	PC Difüzör	3000/4000/6500K	IP66	LED Çip Ömrü L70 Tc@105°C >102.000h.	LED Sürecü Ömrü Tc@65°C 120.000h
<b>Opsiyonlar</b>	DALI	1-10V	Acil Aydınlatma (1-3 saat)	Radarsensör		

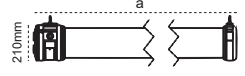

ZONE 1  
ZONE 21  
II 2G Ex db IIB T6 Gb  
II 2D Ex tb IIIC (T85°C) Db



## Exta Ex-Proof Yüksek Tavan Armatürü

Kod	Güç (W)	Renk Sıcaklığı (K)	Işık Akısı (lm)	Etkinlik Faktörü (lm/W)	Boyutlar (mm)axbxc	Koli Ağırlığı (kg)	Koli Adedi	Fiyat
115874	75	6500	9900	132	1320x182x168	10,5	1	675,00\$
115875	100	6500	13700	137	1620x182x168	13	1	945,00\$
115489	150	6500	19800	132	1620x182x168	13	1	1.100,00\$

<b>Özellikler</b>	Alüminyum	PC Difüzör	3000/4000/6500K	IP66	LED Çip Ömrü L70 Tc@105°C >102.000h.	LED Sürecü Ömrü Tc@65°C 120.000h
<b>Opsiyonlar</b>	DALI	1-10V	Acil Aydınlatma (1-3 saat)	Radarsensör		

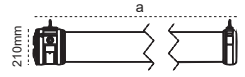

ZONE 1  
ZONE 21  
II 2G Ex db IIB T6 Gb  
II 2D Ex tb IIIC (T85°C) Db



## Exta Exit Ex-Proof Acil Aydınlatma ve Yönlendirme Armatürü

Kod	Güç (W)	Batarya	Şarj Süresi	Deşarj Süresi	Renk Sıcaklığı (K)	Işık Akısı (lm)	Etkinlik Faktörü (lm/W)	Boyutlar (mm)axbxc	Koli Ağırlığı (kg)	Koli Adedi	Fiyat
115488	8	3,7V 4500mAh	24h.	3h.	6500	480	60	471x182x168	3,8	1	585,00\$

<b>Özellikler</b>	Alüminyum	PC Difüzör	3000/4000/6500K	IP66	50.000h	Acil Aydınlatma (1-3 saat)
-------------------	-----------	------------	-----------------	------	---------	----------------------------

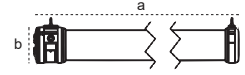

ZONE 1  
ZONE 21  
II 2G Ex db IIB T4-T6 Gb  
II 2D Ex tb IIIC (T85°C...T130°C) Db



## Atarex Ex-Proof Yüksek Tavan Armatürü

Kod	Güç (W)	Renk Sıcaklığı (K)	Işık Akısı (lm)	Etkinlik Faktörü (lm/W)	Boyutlar (mm)axbxc	Koli Ağırlığı (kg)	Koli Adedi	Fiyat
115866	50	6500	6000	120	342x307x241	15,3	1	1.600,00\$
115867	100	6500	13200	132	342x307x241	15,3	1	1.625,00\$
115868	150	6500	19350	129	342x307x241	15,3	1	1.675,00\$
115869	200	6500	25000	125	342x307x241	15,3	1	1.675,00\$
115870	240	6500	29520	123	342x307x241	15,3	1	1.955,00\$

<b>Özellikler</b>	Alüminyum	Temperli Cam	3000/4000/6500K	IP66	LED Çip Ömrü L70 Tc@105°C >102.000h.	LED Sürecü Ömrü Tc@60°C 120.000h
<b>Opsiyonlar</b>	DALI	1-10V	Acil Aydınlatma (1-3 saat)	RAL Kod	30° / 60° / 90°	

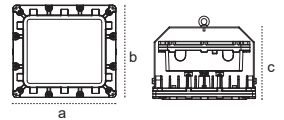

ZONE 1  
ZONE 21  
II 2G Ex db IIB T4-T6 Gb  
II 2D Ex tb IIIC (T85°C...T130°C) Db



## Atarex Ex-Proof Projektör

Kod	Güç (W)	Renk Sıcaklığı (K)	Işık Akısı (lm)	Etkinlik Faktörü (lm/W)	Boyutlar (mm)axbxc	Koli Ağırlığı (kg)	Koli Adedi	Fiyat
115486	50	6500	6000	120	342x350x264	15,5	1	1.600,00\$
115865	100	6500	13200	132	342x350x264	15,5	1	1.625,00\$
115864	150	6500	19350	129	342x350x264	15,5	1	1.675,00\$
115863	200	6500	25000	125	342x350x264	15,5	1	1.675,00\$
115487	240	6500	29520	123	342x350x264	15,5	1	1.955,00\$
115780	480	6500	50400	105	438x754x488	24,9	1	4.200,00\$

<b>Özellikler</b>	Alüminyum	Temperli Cam	3000/4000/6500K	IP66	LED Çip Ömrü L70 Tc@105°C >102.000h.	LED Sürecü Ömrü Tc@60°C 120.000h
<b>Opsiyonlar</b>	DALI	1-10V	Acil Aydınlatma (1-3 saat)	RAL Kod	30° / 60° / 90°	

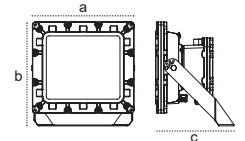



# Zone 1, Zone 21 ATEX Belgeli Ex-Proof Armatürler

Pelsan

● Gaz Patlama Koruması: Zone 1 ● Toz Patlama Koruması: Zone 21



## Nairo Ex-Proof Projektör

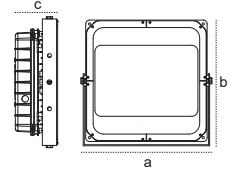

Kod	Güç (W)	Renk Sıcaklığı (K)	Işık Akısı (lm)	Etkinlik Faktörü (lm/W)	Boyutlar (mm)axbxc	Koli Ağırlığı (kg)	Koli Adedi	Fiyat
117820	50	6500	8650	173	342x342x121	8	1	720,00\$
117821	75	6500	12225	163	342x342x121	8	1	812,00\$
117822	100	6500	15700	157	342x342x121	8	1	905,00\$
117823	125	6500	20000	160	342x342x121	8	1	996,00\$
117824	150	6500	22050	147	342x342x121	8	1	1.088,00\$
117825	200	6500	29600	148	342x342x121	8	1	1.201,00\$

ZONE 1  
ZONE 21  
II 2G Ex eb mb IIC T4...T6 Gb  
II 2D Ex tb IIIC (T85...120°C) Db  
2014/34/EU ATEX



Özellikler: Alüminyum, Temperli Cam, 4000/5700/6500K, IP66, LED Çip Ömrü L70 Tc@105°C >102.000h, LED Süreci Ömrü Tc@65°C 120.000h

Opsiyonlar: 30° / 60° / 90°



## Sia Ex-Proof Yüksek Tavan Armatürü

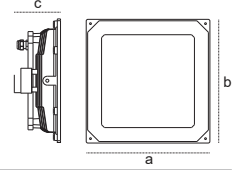

Kod	Güç (W)	Renk Sıcaklığı (K)	Işık Akısı (lm)	Etkinlik Faktörü (lm/W)	Boyutlar (mm)axbxc	Koli Ağırlığı (kg)	Koli Adedi	Fiyat
117778	50	6500	8650	173	341x341x135	4,8	1	720,00\$
117754	75	6500	12225	163	341x341x135	4,8	1	812,00\$
117753	100	6500	15700	157	341x341x135	4,8	1	905,00\$
117752	125	6500	20000	160	341x341x135	4,8	1	996,00\$
117751	150	6500	22050	147	341x341x135	4,8	1	1.088,00\$
117352	200	6500	29600	148	341x341x135	4,8	1	1.201,00\$

ZONE 1  
ZONE 21  
II 2G Ex eb mb IIC T4...T6 Gb  
II 2D Ex tb IIIC (T85...120°C) Db  
2014/34/EU ATEX



Özellikler: Alüminyum, Temperli Cam, 4000/5700/6500K, IP66, LED Çip Ömrü L70 Tc@105°C >137.000h, LED Süreci Ömrü Tc@55°C 120.000h

Opsiyonlar: DALI, 1-10V, 30° / 60° / 90°

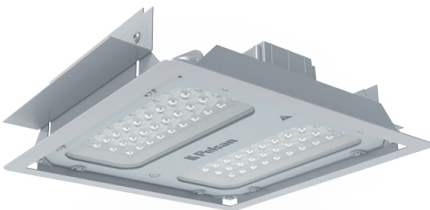

## Piriliz Ex-Proof Kanopi

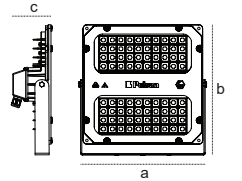

Kod	Güç (W)	Renk Sıcaklığı (K)	Işık Akısı (lm)	Etkinlik Faktörü (lm/W)	Boyutlar (mm)axbxc	Koli Ağırlığı (kg)	Koli Adedi	Fiyat
117826	50	6500	8650	173	395x395x124	8	1	720,00\$
117827	75	6500	12225	163	395x395x124	8	1	812,00\$
117828	100	6500	15700	157	395x395x124	8	1	905,00\$
117829	125	6500	20000	160	395x395x124	8	1	996,00\$
117830	150	6500	22050	147	395x395x124	8	1	1.088,00\$
117831	200	6500	29600	148	395x395x124	8	1	1.201,00\$

ZONE 1  
ZONE 21  
II 2G Ex eb mb IIC T4...T6 Gb  
II 2D Ex tb IIIC (T85...120°C) Db  
2014/34/EU ATEX



Özellikler: Alüminyum, Temperli Cam, 4000/5700/6500K, IP66, LED Çip Ömrü L70 Tc@105°C >102.000h, LED Süreci Ömrü Tc@65°C 120.000h

Opsiyonlar: 30° / 60° / 90°



# Zone2, Zone22 ATEX Belgeli Ex-Proof Armatürler

**Pelsan**

● Gaz Patlama Koruması: Zone 2 ● Toz Patlama Koruması: Zone 22



## Inovaled G3 Ex-Proof Etanj

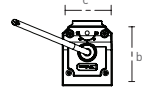

Kod	Güç (W)	Renk Sıcaklığı (K)	Işık Akısı (lm)	Etkinlik Faktörü (lm/W)	Boyutlar (mm)axbxc	Koli Ağırlığı (kg)	Koli Adedi	Fiyat
117895	19	6500	2033	107	630x82x63	-	8,6	275,00\$
117894	26	6500	2782	107	910x82x63	-	10,7	290,00\$
117893	34	6500	3672	108	1190x82x63	-	14,7	295,00\$
118234	50	6500	5400	108	910x82x63	-	10,7	325,00\$
118233	75	6500	8250	110	910x82x63	-	10,7	350,00\$
117898	100	6500	12300	123	910x82x63	-	10,7	389,00\$
117897	120	6500	15000	125	1190x82x63	-	14,7	414,00\$
117896	150	6500	18750	125	1470x82x62	-	19,7	439,00\$

**Özellikler** Alüminyum Temperli Cam 4000/5700/6500K IP66 50.000h

**Opsiyonlar** 30° / 60° / 90°



## Largo G2 Ex-Proof Etanj

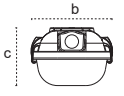

Kod	Güç (W)	Renk Sıcaklığı (K)	Işık Akısı (lm)	Etkinlik Faktörü (lm/W)	Boyutlar (mm)axbxc	Koli Ağırlığı (kg)	Koli Adedi	Fiyat
117570	14	6500	1862	133	610x80x75	11,7	9	211,50\$
117571	20	6500	2640	132	610x80x75	11,7	9	211,50\$
117139	27	6500	3159	117	610x80x75	11,7	9	213,50\$
117574	26	6500	3458	133	1150x80x75	22	9	225,00\$
117573	34	6500	4420	130	1150x80x75	22	9	225,00\$
117572	50	6500	6500	130	1150x80x75	22	9	229,25\$
117141	75	6500	8550	114	1150x80x75	22	9	249,00\$
117575	75	6500	8850	118	1500x80x75	27,9	9	279,00\$
117142	100	6500	11200	112	1500x80x75	27,9	9	299,00\$

**Özellikler** PC PC Difüzör 3000/4000/6500K IP65 LED Çip Ömrü L70 Tc@105°C >102.000h. LED Sürücü Ömrü Tc@65°C 50.000h. 5 Yıl

**Opsiyonlar** DALI 1-10V Acil Aydınlatma (1-3 saat) Radar Sensör Busbar Sarkit



## Largo LED Tube Ex-Proof Etanj

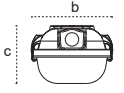

Kod	Güç (W)	Duy	Boyutlar (mm)axbxc	Koli Ağırlığı (kg)	Koli Adedi	Fiyat
111402	1x9 max	1xG13	663x85x85	11	6	93,00\$
111404	2x9 max	2xG13	663x125x85	12,8	6	98,00\$
111405	1x18 max	1xG13	1273x85x85	17	6	117,00\$
111406	2x18 max	2xG13	1273x125x85	18,5	6	119,00\$

**Özellikler** GRP PC Difüzör IP65 50.000h



## Ausled Ex-Proof Acil Aydınlatma

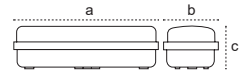

Kod	Güç (W)	Batarya	Şarj Süresi	Deşarj Süresi	Işık Akısı (lm)	Renk Sıcaklığı (K)	Etkinlik Faktörü (lm/W)	Boyutlar (mm)axbxc	Koli Ağırlığı (kg)	Koli Adedi	Fiyat
109710	15	3,7V 4500mAh	24h	3h	1500	6500	100	350x117x76	5,5	6	108,50\$

**Özellikler** PC PC Difüzör 3000/4000/6500K IP65 50.000h

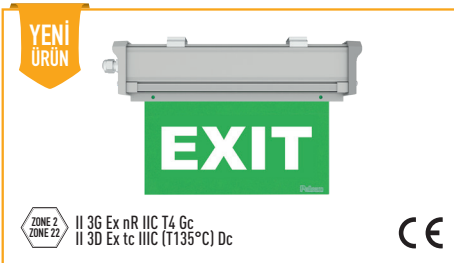

## Inovaled G3 Acil Aydınlatma ve Yönlendirme

Kod	Güç (W)	Batarya	Şarj Süresi	Deşarj Süresi	Işık Akısı (lm)	Renk Sıcaklığı (K)	Boyutlar (mm)axbxc	Koli Ağırlığı (kg)	Koli Adedi	Fiyat
118345	8	3,2V 1800mAh	24h	3h	320	6500	340x220x65	-	-	98,50\$

**Özellikler** Alüminyum Temperli Cam IP66





# Zone2, Zone22 ATEX Belgeli Ex-Proof Armatürler

Pelsan

● Gaz Patlama Koruması: Zone 2 ● Toz Patlama Koruması: Zone 22



ZONE 2  
ZONE 22  
II 3G Ex ec IIC T5 Gc  
II 3D Ex tc IIIC (T195°C) DC



## Elit Lirad Ex-Proof Projektör

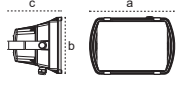

Kod	Güç (W)	Renk Sıcaklığı (K)	Işık Akısı (lm)	Etkinlik Faktörü (lm/W)	Boyutlar (mm)axbxc	Koli Ağırlığı (kg)	Koli Adedi	Fiyat
109707	50	6500	7000	140	295x200x175	18	6	258,00\$

Özellikler	GRP	Temperli Cam	4000/5700/6500K	IP65	50.000h
Opsiyonlar	30° / 60° / 90°				



ZONE 2  
ZONE 22  
II 3G Ex ec IIC T5 Gc  
II 3D Ex tc IIIC (T195°C) DC



## Nairo Ex-Proof Projektör

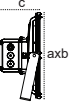

Kod	Güç (W)	Renk Sıcaklığı (K)	Işık Akısı (lm)	Etkinlik Faktörü (lm/W)	Boyutlar (mm)axbxc	Koli Ağırlığı (kg)	Koli Adedi	Fiyat
111372	50	6500	8650	173	342x342x121	8	1	398,00\$
111371	75	6500	12225	163	342x342x121	8	1	450,00\$
111370	100	6500	15700	157	342x342x121	8	1	502,00\$
111369	125	6500	20000	160	342x342x121	8	1	553,00\$
111368	150	6500	22050	147	342x342x121	8	1	604,00\$
111055	200	6500	29600	148	342x342x121	8	1	667,00\$

Özellikler	Alüminyum	Temperli Cam	4000/5700/6500K	IP66	50.000h
Opsiyonlar	30° / 60° / 90°				



ZONE 2  
ZONE 22  
II 3G Ex ec IIC T5 Gc  
II 3D Ex tc IIIC (T195°C) DC



## Sia Ex-Proof Yüksek Tavan Armatürü

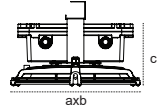

Kod	Güç (W)	Renk Sıcaklığı (K)	Işık Akısı (lm)	Etkinlik Faktörü (lm/W)	Boyutlar (mm)axbxc	Koli Ağırlığı (kg)	Koli Adedi	Fiyat
111381	50	6500	8650	173	342x342x160	8	1	398,00\$
111380	75	6500	12225	163	342x342x160	8	1	450,00\$
111379	100	6500	15700	157	342x342x160	8	1	502,00\$
111378	125	6500	20000	160	342x342x160	8	1	553,00\$
111377	150	6500	22050	147	342x342x160	8	1	604,00\$
111053	200	6500	29600	148	342x342x160	8	1	667,00\$

Özellikler	Alüminyum	Temperli Cam	4000/5700/6500K	IP66	50.000h
Opsiyonlar	30° / 60° / 90°				



ZONE 2  
ZONE 22  
II 3G Ex ec IIC T5 Gc  
II 3D Ex tc IIIC (T195°C) DC



## Piroliz Ex-Proof Kanopi Armatürü

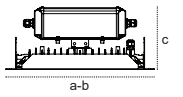

Kod	Güç (W)	Renk Sıcaklığı (K)	Işık Akısı (lm)	Etkinlik Faktörü (lm/W)	Boyutlar (mm)axbxc	Koli Ağırlığı (kg)	Koli Adedi	Fiyat
111376	50	6500	8650	173	395x385x132	8	1	398,00\$
111375	75	6500	12225	163	395x385x132	8	1	450,00\$
111374	100	6500	15700	157	395x385x132	8	1	502,00\$
111382	125	6500	20000	160	395x385x132	8	1	553,00\$
111373	150	6500	22050	147	395x385x132	8	1	604,00\$
111056	200	6500	29600	148	395x385x132	8	1	667,00\$

Özellikler	Alüminyum	Temperli Cam	4000/5700/6500K	IP66	50.000h
Opsiyonlar	30° / 60° / 90°				



ZONE 2  
ZONE 22  
II 3G Ex ec IIC T5 Gc  
II 3D Ex tc IIIC (T195°C) DC



## Nairo SL Ex-Proof Yol-Cadde Armatürü

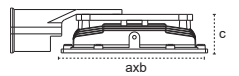

Kod	Güç (W)	Renk Sıcaklığı (K)	Işık Akısı (lm)	Etkinlik Faktörü (lm/W)	Boyutlar (mm)axbxc	Konsol Girişi (mm)	Koli Ağırlığı (kg)	Koli Adedi	Fiyat
111365	100	4000	15200	152	352x352x152	42-60	8	1	518,00\$
111364	125	4000	18625	149	352x352x152	42-60	8	1	569,00\$
111363	150	4000	21900	146	352x352x152	42-60	8	1	620,00\$
111362	200	4000	28000	140	352x352x152	42-60	8	1	683,00\$

Özellikler	Alüminyum	Temperli Cam	4000/5700/6500K	IP66	50.000h
------------	-----------	--------------	-----------------	------	---------

# Pelsan

## CRUZO G2

YÜKSEK GÜÇLÜ PROJEKTÖR SERİSİ



CB

EAC



1800W



250200 lm



160 lm/W



HD Yayın



Flicker Free



CRI90

DALI  
DMX RDM

## CB ve ENEC Belgeli Yüksek Güçlü Projektör

90°'ye Kadar  
Ayarlanabilir Konsol

Ayarlanabilir  
Gövde ( $\pm 30^\circ$ )

IP67 ENEC  
Belgeli Driver ve  
IP66 Driver Kutusu

Alüminyum  
Enjeksiyon Konsol

IP66 Alüminyum  
Enjeksiyon Gövde

10° / 17° / 30° / 60° / 90° / Asimetrik  
Lens Opsiyonu

ürün  
broşürü



### Cruzo IP66 500-600W Projektör

10kV Dahili  
Parafudr

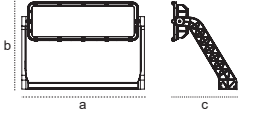

Kod	Güç (W)	Renk Sıcaklığı (K)	Işık Akısı (lm)	Etkinlik Faktörü (lm/W)	Boyutlar (mm)axbxc	Koli Ağırlığı (kg)	Koli Adedi	Fiyat
115898	500	5700	70000	140	716x387x319	18	1	950,00\$
115975	600	5700	83400	139	716x387x319	18	1	950,00\$



<b>Özellikler</b>	Alüminyum	Temperli Cam	4000/5700/6500K	IP66	LED Çip Ömrü L70 Tc@105°C >102.000h	LED Sürücü Ömrü Tc@65°C 120.000h
<b>Opsiyonlar</b>	DALI	1-10V	Step DIM	Elektriksel Sınıf I/II	10° / 30° / 60° / 90° Asimetrik	

### Cruzo IP66 800-1200W Projektör

10kV Dahili  
Parafudr

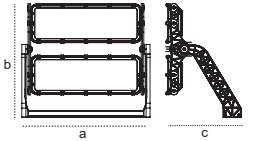

Kod	Güç (W)	Renk Sıcaklığı (K)	Işık Akısı (lm)	Etkinlik Faktörü (lm/W)	Boyutlar (mm)axbxc	Koli Ağırlığı (kg)	Koli Adedi	Fiyat
115976	800	5700	128000	160	816x722x560	29	1	1.625,00\$
115977	900	5700	140400	156	816x722x560	29	1	1.625,00\$
115899	1000	5700	150000	150	816x722x560	29	1	1.625,00\$
115978	1200	5700	175200	146	816x722x560	29	1	2.159,00\$



<b>Özellikler</b>	Alüminyum	Temperli Cam	4000/5700/6500K	IP66	LED Çip Ömrü L70 Tc@105°C >102.000h	LED Sürücü Ömrü Tc@65°C 120.000h
<b>Opsiyonlar</b>	DALI	1-10V	Step DIM	Elektriksel Sınıf I/II	10° / 30° / 60° / 90° Asimetrik	

### Cruzo IP66 1500-1800W Projektör

10kV Dahili  
Parafudr

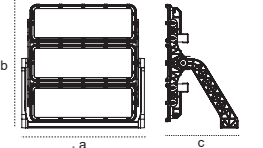

Kod	Güç (W)	Renk Sıcaklığı (K)	Işık Akısı (lm)	Etkinlik Faktörü (lm/W)	Boyutlar (mm)axbxc	Koli Ağırlığı (kg)	Koli Adedi	Fiyat
115900	1500	5700	222000	148	816x823x580	40	1	3.500,00\$
115901	1800	5700	250200	139	816x823x580	40	1	3.500,00\$



<b>Özellikler</b>	Alüminyum	Temperli Cam	4000/5700/6500K	IP66	LED Çip Ömrü L70 Tc@105°C >102.000h	LED Sürücü Ömrü Tc@65°C 120.000h
<b>Opsiyonlar</b>	DALI	1-10V	Step DIM	Elektriksel Sınıf I/II	Marin Boya	30° / 60° / 90° Asimetrik



RIA

RIA MED S

RIA MED G2

YENİ ÜRÜN



### Ria Med S 30-100W Projektör

**10kV Dahili Parafudr**

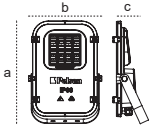

Kod	Güç (W)	Renk Sıcaklığı (K)	Işık Akısı (lm)	Etkinlik Faktörü (lm/W)	Boyutlar (mm)axbxc	Koli Ağırlığı (kg)	Koli Adedi	Fiyat
117704	30	6500	4050	135	312x240x75	-	6	102,50\$
117705	35	6500	4830	138	312x240x75	-	6	102,50\$
117706	50	6500	6750	135	312x240x75	-	6	102,50\$
117707	60	6500	8100	135	312x240x75	-	6	109,00\$
117708	75	6500	10500	140	312x240x75	-	6	127,00\$
117709	100	6500	13000	130	312x240x75	-	6	127,00\$

**Özellikler** Alüminyum Temperli Cam 3000/4000/6500K IP66 LED Çip Ömrü L70 Tc@105°C >102.000h. LED Sürücü Ömrü Tc@65°C 120.000h. 5 Yıl

**Opsiyonlar** DALI 1-10V Step DIM I/II Elektriksel Sınıf Marin Boya 30° / 60° / 90° Asimetrik\*\*

\*\*Asimetrik Lens 50 - 100 W arasında sunulmaktadır.

### Ria Med G2 IP66 60-200W Projektör

**10kV Dahili Parafudr**

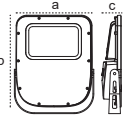

Kod	Güç (W)	Renk Sıcaklığı (K)	Işık Akısı (lm)	Etkinlik Faktörü (lm/W)	Boyutlar (mm)axbxc	Koli Ağırlığı (kg)	Koli Adedi	Fiyat
111788	60	6500	8820	147	274x340x66	15,05	4	126,00\$
111785	80	6500	11360	142	274x340x66	15,05	4	160,00\$
111660	100	6500	13400	134	274x340x66	15,05	4	160,00\$
111666	150	6500	20700	138	274x340x66	15,05	4	187,00\$
116136	200	6500	27600	138	274x340x66	15,05	4	300,00\$

**Özellikler** Alüminyum Temperli Cam 3000/4000/6500K IP66 LED Çip Ömrü L70 Tc@105°C >102.000h. LED Sürücü Ömrü Tc@65°C 120.000h. 5 Yıl

**Opsiyonlar** DALI 1-10V Step DIM I/II Elektriksel Sınıf Marin Boya 30° / 60° / 90° Asimetrik\*\*

\*\*Asimetrik Lens 50 - 100 W arasında sunulmaktadır.

### Ria IP66 Simetrik 200-400W Projektör

**10kV Dahili Parafudr**

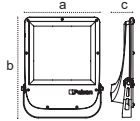

Kod	Güç (W)	Renk Sıcaklığı (K)	Işık Akısı (lm)	Etkinlik Faktörü (lm/W)	Boyutlar (mm)axbxc	Koli Ağırlığı (kg)	Koli Adedi	Fiyat
115918	200	6500	30800	154	400x418x100	6	1	430,00\$
115919	250	6500	36500	146	400x418x100	6	1	464,00\$
115920	300	6500	42600	142	400x418x100	6	1	505,00\$
115921	400	6500	60800	152	400x418x100	6	1	585,00\$

**Özellikler** Alüminyum Temperli Cam 3000/4000/6500K IP66 LED Çip Ömrü L70 Tc@105°C >102.000h. LED Sürücü Ömrü Tc@65°C 120.000h. 5 Yıl

**Opsiyonlar** DALI 1-10V Step DIM I/II Elektriksel Sınıf Marin Boya 30° / 60° / 90° Asimetrik\*\*

\*\*Asimetrik Lens 180-300W arasında sunulmaktadır.



# Sınıfının En Verimlisi

## 131lm/W

### Lecto



### Lecto G2 50W - 100W

Projektör



Kod	Güç (W)	Renk Sıcaklığı (K)	Işık Akısı (lm)	Etkinlik Faktörü (lm/W)	Boyutlar (mm)axbxc	Koli Ağırlığı (kg)	Koli Adedi	Fiyat
116003	50	3000	6550	131	220x176x30	16,5	20	26,00\$
115747	50	5000	6550	131	220x176x30	16,5	20	26,00\$
116004	100	3000	12800	128	257x217x30	14,5	12	55,00\$
115748	100	5000	12800	128	257x217x30	14,5	12	55,00\$



Özellikler



Alüminyum



Temperli Cam



3000K / 5000K



IP65



30.000h

### Lecto G2 150W - 200W

Projektör



Kod	Güç (W)	Renk Sıcaklığı (K)	Işık Akısı (lm)	Etkinlik Faktörü (lm/W)	Boyutlar (mm)axbxc	Koli Ağırlığı (kg)	Koli Adedi	Fiyat
116005	150	3000	18900	126	313x247x30	16,5	10	73,90\$
115818	150	5000	18900	126	313x247x30	16,5	10	73,90\$
116006	200	3000	25000	125	375x302x34	15,5	6	94,10\$
115819	200	5000	25000	125	375x302x34	15,5	6	94,10\$



Özellikler



Alüminyum



Temperli Cam



3000K / 5000K



IP65



30.000h

### Lecto G2 300W - 400W

Projektör



Kod	Güç (W)	Renk Sıcaklığı (K)	Işık Akısı (lm)	Etkinlik Faktörü (lm/W)	Boyutlar (mm)axbxc	Koli Ağırlığı (kg)	Koli Adedi	Fiyat
117619	300	5000	36000	120	450x368x40	21,4	6	251,00\$
117618	400	5000	50000	125	495x420x44	19,2	4	251,00\$



Özellikler



Alüminyum



Temperli Cam



3000K / 5000K



IP65



30.000h

### Lecto Max

400-500W Projektör

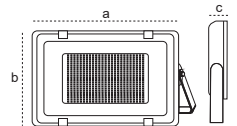
Kod	Güç (W)	Renk Sıcaklığı (K)	Işık Akısı (lm)	Etkinlik Faktörü (lm/W)	Boyutlar (mm)axbxc	Koli Ağırlığı (kg)	Koli Adedi	Fiyat
115485	400	5000	40000	100	550x395x60	6,7	1	347,00\$
115484	500	5000	50000	100	605x460x65	10,5	1	577,00\$



Özellikler



Alüminyum



Temperli Cam



5000K



IP65



30.000h

## Uzun Ömürlü, Yüksek Verimli...

Gaziantep Kalesi LED Aydınlatması,  
Pelsan Aydınlatma M. Reşit Göğüş tarafından  
yapılmıştır.



**Hava Ventilli  
Rakor ile  
Nem Yapmaz!**

**IP66  
Toz ve Su Almaz**

**IK08  
Darbe Dayanımı**

**Alüminyum  
Gövde**

**Temperli  
Cam**

### Inovaled G3 IP66

Sıva Üstü Wallwasher

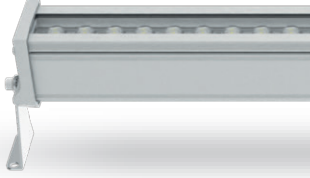

Kod	Tip	Güç (W)	Renk Sıcaklığı (K)	Işık Akısı (lm)	Etkinlik Faktörü (lm/W)	Boyutlar (mm)axbxc	Koli Ağırlığı (kg)	Koli Adedi	Fiyat
116590	45+20°	14	3000	1540	110	327x75x63	5,8	6	46,50\$
116591	45+20°	14	4000	1540	110	327x75x63	5,8	6	46,50\$
116592	45+20°	14	6500	1540	110	327x75x63	5,8	6	46,50\$

**Özellikler** Alüminyum Temperli Cam 4000/5700/6500K IP66 50.000h

**Opsiyonlar** Amber Renk Yeşil Renk Kırmızı Renk Mavi Renk

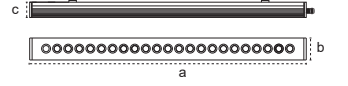

### Inovaled G3 IP66

Sıva Üstü Wallwasher



Kod	Tip	Güç (W)	Renk Sıcaklığı (K)	Işık Akısı (lm)	Etkinlik Faktörü (lm/W)	Boyutlar (mm)axbxc	Koli Ağırlığı (kg)	Koli Adedi	Fiyat
116605	45+20°	28	3000	3080	110	622x75x63	8,5	6	74,70\$
116604	45+20°	28	4000	3080	110	622x75x63	8,5	6	74,70\$
116603	45+20°	28	6500	3080	110	622x75x63	8,5	6	74,70\$

**Özellikler** Alüminyum Temperli Cam 4000/5700/6500K IP66 50.000h

**Opsiyonlar** Amber Renk Yeşil Renk Kırmızı Renk Mavi Renk

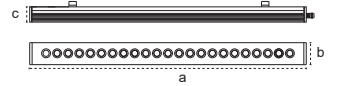

### Inovaled G3 IP66

Sıva Üstü Wallwasher

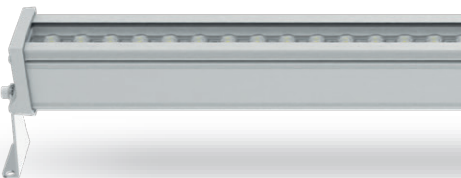

Kod	Tip	Güç (W)	Renk Sıcaklığı (K)	Işık Akısı (lm)	Etkinlik Faktörü (lm/W)	Boyutlar (mm)axbxc	Koli Ağırlığı (kg)	Koli Adedi	Fiyat
116613	45+20°	42	3000	4620	110	917x75x63	10,6	6	116,90\$
116612	45+20°	42	4000	4620	110	917x75x63	10,6	6	116,90\$
116611	45+20°	42	6500	4620	110	917x75x63	10,6	6	116,90\$

**Özellikler** Alüminyum Temperli Cam 4000/5700/6500K IP66 50.000h

**Opsiyonlar** Amber Renk Yeşil Renk Kırmızı Renk Mavi Renk

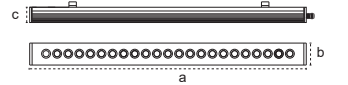

# RIO Senseway



RIO XS G3

RIO XXS G3

RIO Senseway entegre akıllı kontrol sistemleriyle aydınlatmayı yönetebilir hale getirir. **Uzaktan izleme, esnek senaryo tanımlama** ve enerji verimliliği odaklı kontrol altyapısı, şehir aydınlatmasında maksimum performans ile sürdürülebilirliği bir arada sunar.



%80'e Varan  
Enerji Tasarrufu



1-2 Yıl İçinde Kendini  
Amorti Eden Yatırım



Anında Arıza  
Tespiti ve Raporlama



Kolay Kurulum ve  
Bakım

Fiyat Sorunuz: [info@pelsan.com.tr](mailto:info@pelsan.com.tr)

**Rio XXS**

**10kV Dahili Parafudr**

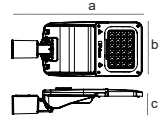

**160lm/W'a Varan Verimlilik**



Kod	Güç (W)	Renk Sıcaklığı (K)	Işık Akısı (lm)	Etkinlik Faktörü (lm/W)	Boyutlar (mm)axbxc	Konsol Girişi	Koli Ağırlığı (kg)	Koli Adedi	Fiyat
115610	35	4000	5600	160	525x178x120	42-60	3,3	1	156,50\$
115611	50	4000	7700	154	525x178x120	42-60	3,3	1	156,50\$
115612	60	4000	8880	148	525x178x120	42-60	3,3	1	156,50\$
116421	75	4000	11250	150	525x178x120	42-60	3,3	1	175,00\$
116422	100	4000	14000	140	525x178x120	42-60	3,3	1	175,00\$

<b>Özellikler</b>	Alüminyum	Temperli Cam	3000/4000/6500K	IP66	LED Çip Ömrü L70 Tc@105°C >137.000h	LED Sürücü Ömrü Tc@55°C 120.000h	5 Yıl
<b>Opsiyonlar</b>	DALI	1-10V	Step DIM	Nema Soket	Zhaga Soket	Elektriksel Sınıf I/II	Marin Boya

**Rio Xs G3**

**10kV Dahili Parafudr**

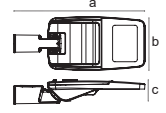

**165lm/W'a Varan Verimlilik**



Kod	Güç (W)	Renk Sıcaklığı (K)	Işık Akısı (lm)	Etkinlik Faktörü (lm/W)	Boyutlar (mm)axbxc	Konsol Girişi	Koli Ağırlığı (kg)	Koli Adedi	Fiyat
115994	50	4000	8250	165	551x230x170	42-60	3,5	1	175,00\$
115995	60	4000	9900	165	551x230x170	42-60	3,5	1	175,00\$
115996	80	4000	11400	143	551x230x170	42-60	3,5	1	197,50\$
115997	100	4000	15000	150	551x230x170	42-60	3,5	1	197,50\$
116403	125	4000	18625	149	551x230x170	42-60	3,5	1	250,00\$
116405	150	4000	20550	137	551x230x170	42-60	3,5	1	250,00\$

<b>Özellikler</b>	Alüminyum	Temperli Cam	3000/4000/6500K	IP66	LED Çip Ömrü L70 Tc@105°C >137.000h	LED Sürücü Ömrü Tc@55°C 120.000h	5 Yıl
<b>Opsiyonlar</b>	DALI	1-10V	Step DIM	Nema Soket	Zhaga Soket	Elektriksel Sınıf I/II	Marin Boya

**Rio S G2 IP66**

**10kV Dahili Parafudr**

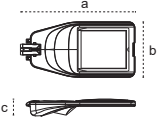

**165lm/W'a Varan Verimlilik**



Kod	Güç (W)	Renk Sıcaklığı (K)	Işık Akısı (lm)	Etkinlik Faktörü (lm/W)	Boyutlar (mm)axbxc	Konsol Girişi	Koli Ağırlığı (kg)	Koli Adedi	Fiyat
115117	80	4000	13200	165	476x280x111	42-60	6,1	1	330,00\$
115119	100	4000	16300	163	476x280x111	42-60	6,1	1	330,00\$
115141	125	4000	19125	153	476x280x111	42-60	6,1	1	340,00\$
115142	150	4000	23550	157	476x280x111	42-60	6,1	1	340,00\$

<b>Özellikler</b>	Alüminyum	Temperli Cam	3000/4000/6500K	IP66	LED Çip Ömrü L70 Tc@105°C >137.000h	LED Sürücü Ömrü Tc@55°C 120.000h	5 Yıl
<b>Opsiyonlar</b>	DALI	1-10V	Step DIM	Nema Soket	Zhaga Soket	Elektriksel Sınıf I/II	Marin Boya

**Rio M G2 IP66**

**10kV Dahili Parafudr**

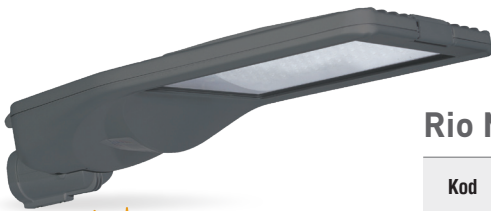
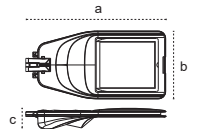

**160lm/W'a Varan Verimlilik**



Kod	Güç (W)	Renk Sıcaklığı (K)	Işık Akısı (lm)	Etkinlik Faktörü (lm/W)	Boyutlar (mm)axbxc	Konsol Girişi	Koli Ağırlığı (kg)	Koli Adedi	Fiyat
115125	180	4000	28800	160	616x330x124	42-60	7,5	1	490,00\$
115126	200	4000	31600	158	616x330x124	42-60	7,5	1	490,00\$

<b>Özellikler</b>	Alüminyum	Temperli Cam	3000/4000/6500K	IP66	LED Çip Ömrü L70 Tc@105°C >137.000h	LED Sürücü Ömrü Tc@55°C 120.000h	5 Yıl
<b>Opsiyonlar</b>	DALI	1-10V	Step DIM	Nema Soket	Zhaga Soket	Elektriksel Sınıf I/II	Marin Boya

**Rio L IP66**

**10kV Dahili Parafudr**

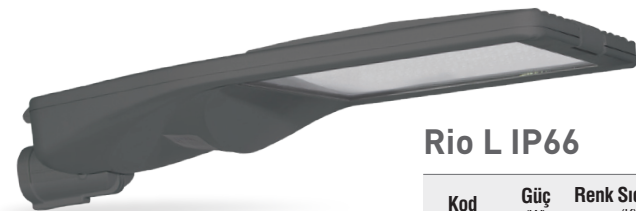
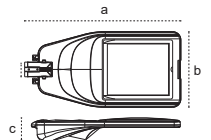

**145lm/W'a Varan Verimlilik**



Kod	Güç (W)	Renk Sıcaklığı (K)	Işık Akısı (lm)	Etkinlik Faktörü (lm/W)	Boyutlar (mm)axbxc	Konsol Girişi	Koli Ağırlığı (kg)	Koli Adedi	Fiyat
110784	240	4000	34800	145	727x370x131	42-60	10,1	1	640,00\$
110785	270	4000	38610	143	727x370x131	42-60	10,1	1	640,00\$
110786	300	4000	42000	140	727x370x131	42-60	10,1	1	640,00\$

<b>Özellikler</b>	Alüminyum	Temperli Cam	3000/4000/6500K	IP66	LED Çip Ömrü L70 Tc@105°C >137.000h	LED Sürücü Ömrü Tc@55°C 120.000h	5 Yıl
<b>Opsiyonlar</b>	DALI	1-10V	Step DIM	Nema Soket	Zhaga Soket	Elektriksel Sınıf I/II	Marin Boya



YENİ ÜRÜN



140lm/W'a  
Varan Verimlilik



## Doka S

10kV Dahili  
Parafudr

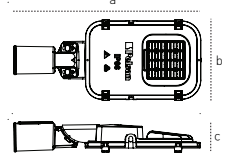

Kod	Güç (W)	Renk Sıcaklığı (K)	Işık Akısı (lm)	Etkinlik Faktörü (lm/W)	Boyutlar (mm)axbxc	Konsol Girişi	Koli Ağırlığı (kg)	Koli Adedi	Fiyat
117673	30	4000	4050	135	310x218x75	42-60	-	6	117,25\$
117674	35	4000	4830	138	310x218x75	42-60	-	6	117,25\$
117675	50	4000	6750	135	310x218x75	42-60	-	6	117,25\$
117676	60	4000	8100	135	310x218x75	42-60	-	6	133,75\$
117677	75	4000	10500	140	310x218x75	42-60	-	6	164,75\$
117678	100	4000	13000	130	310x218x75	42-60	-	6	164,75\$

Özellikler	Alüminyum	Temperli Cam	3000/4000/6500K	IP66	LED Çip Ömrü L70 Tc@105°C >102.000h	LED Sürücü Ömrü Tc@65°C 120.000h	5 Yıl
Opsiyonlar	DALI	1-10V	Step DIM	Elektriksel Sınıf I/II	Marin Boya		



147lm/W'a  
Varan Verimlilik



## Doka G2 IP66

10kV Dahili  
Parafudr

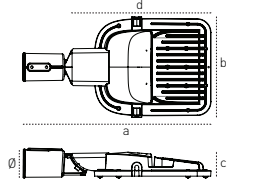

Kod	Güç (W)	Renk Sıcaklığı (K)	Işık Akısı (lm)	Etkinlik Faktörü (lm/W)	Boyutlar (mm)axbxcxd	Konsol Girişi	Koli Ağırlığı (kg)	Koli Adedi	Fiyat
115410	60	4000	8820	147	362x268x65x316	42-60	11,8	4	151,00\$
115412	80	4000	11360	142	362x268x65x316	42-60	11,8	4	165,00\$
115414	100	4000	13800	138	362x268x65x316	42-60	11,8	4	165,00\$
115416	150	4000	19050	127	362x268x65x316	42-60	11,8	4	215,00\$
116241	200	4000	26000	130	362x268x65x316	42-60	11,8	4	330,00\$

Özellikler	Alüminyum	Temperli Cam	3000/4000/6500K	IP66	LED Çip Ömrü L70 Tc@105°C >102.000h	LED Sürücü Ömrü Tc@65°C 120.000h	5 Yıl
Opsiyonlar	DALI	1-10V	Step DIM	Elektriksel Sınıf I/II	Marin Boya		



## Berlin

6kV Dahili  
Parafudr

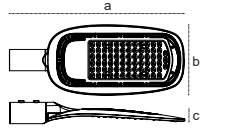

Kod	Güç (W)	Renk Sıcaklığı (K)	Işık Akısı (lm)	Etkinlik Faktörü (lm/W)	Boyutlar (mm)axbxc	Konsol Girişi	Koli Ağırlığı (kg)	Koli Adedi	Fiyat
113622	60	5000	6600	110	409x165x54	42	10	10	80,00\$
114994	80	5000	8400	105	409x165x54	42	10,2	10	113,75\$
113623	100	5000	10500	105	498x201x73	42-60	10,5	6	133,00\$
109856	150	5000	15750	105	571x248x76	42-60	13,8	6	191,00\$



Özellikler	Alüminyum	PC Difüzör	5000K	IP65	30.000h	3 Yıl
------------	-----------	------------	-------	------	---------	-------



ürün videosu



146lm/W'a  
Varan Verimlilik



## Madrid

Denize kıyısı bulanan bölgeler ve marinalar için özel tasarlandı.



ASLA PASLANMAZI!

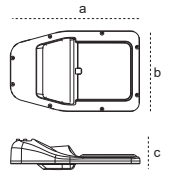

Kod	Güç (W)	Renk Sıcaklığı (K)	Işık Akısı (lm)	Etkinlik Faktörü (lm/W)	Boyutlar (mm)axbxc	Konsol Girişi	Koli Ağırlığı (kg)	Koli Adedi	Fiyat
108494	33	4000	4257	129	324x201x75	42-48	8,7	6	66,50\$
109877	40	4000	5840	146	324x201x75	42-48	8,7	6	82,00\$

Özellikler	PC	PC Difüzör	3000/4000/6500K	IP65	50.000h
------------	----	------------	-----------------	------	---------



**Maksimum Görsel Konfor**

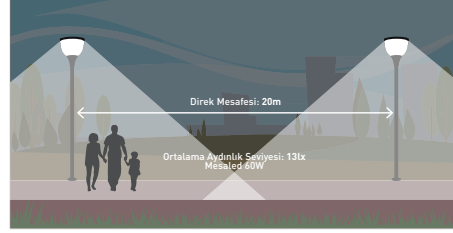

**Luma**

Kod	Güç (W)	Renk Sıcaklığı (K)	Direk Boyutu (mm)	Fiyat
212514	65	4000	3500	400,00\$

Özellikler IP54

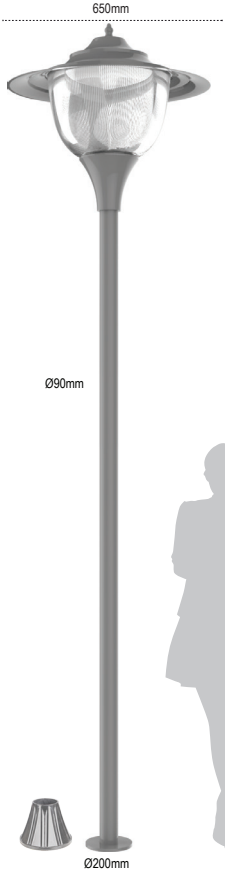

**Kamaşma kontrollü özel difüzör**

- Özel prizmatik difüzör
- Kamaşma yapmayan optik dizayn
- Yüksek ışık geçirgenliği



**Kamaşma Önleyici Özel Difüzörü ile Görsel Konfor Sağlar**

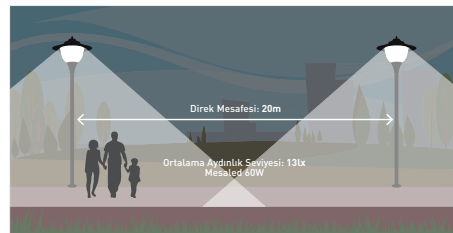

**Meseled**

Kod	Güç (W)	Renk Sıcaklığı (K)	Direk Boyutu (mm)	Fiyat
108609	30	4000	3500	390,00\$
108608	60	4000	3500	430,00\$

Özellikler IP54

\* Özel ölçüler için satış ekibimiz ile iletişime geçiniz.



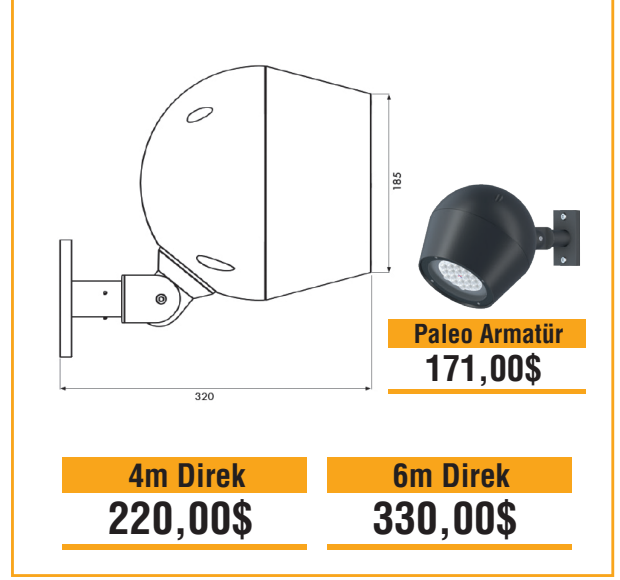
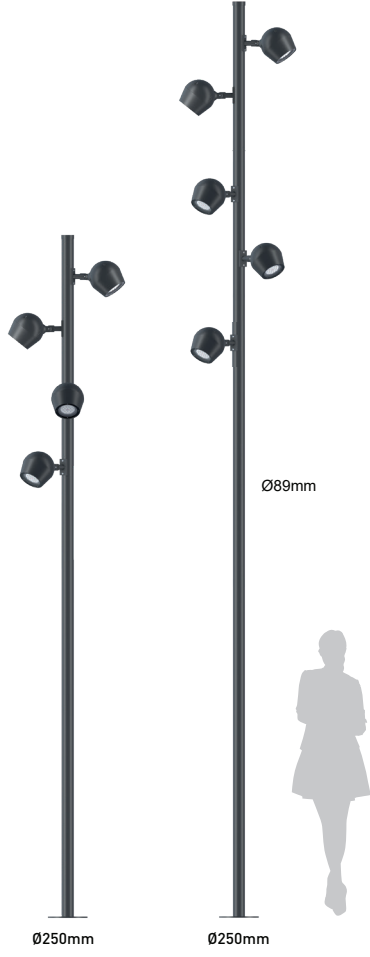

### Paleo

Kod	Güç (W)	Renk Sıcaklığı (K)	Direk Boyutu (mm)	Fiyat
212317	4x30	4000	4000	897,00\$
212318	5x30	4000	6000	1.255,00\$

Özellikler	Alüminyum	Temperli Cam	Galvaniz Direk	IP65
Opsiyonlar	DALI	1-10V	Marin Boya	
	Direk Yüksekliği: 3000 - 6000 mm			

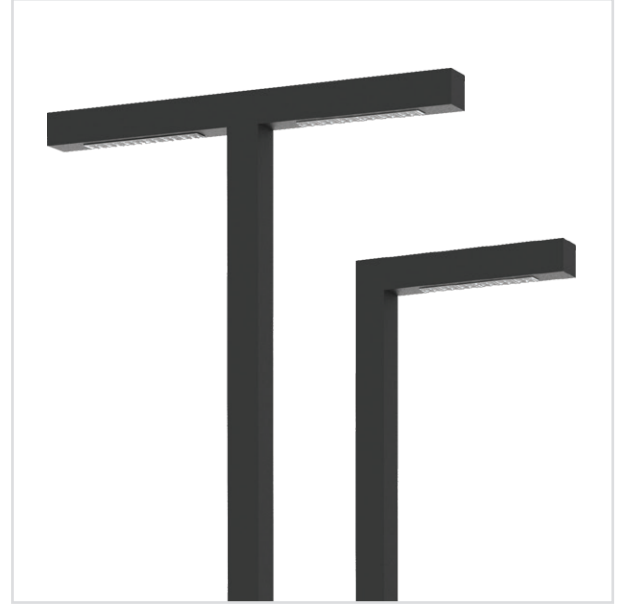
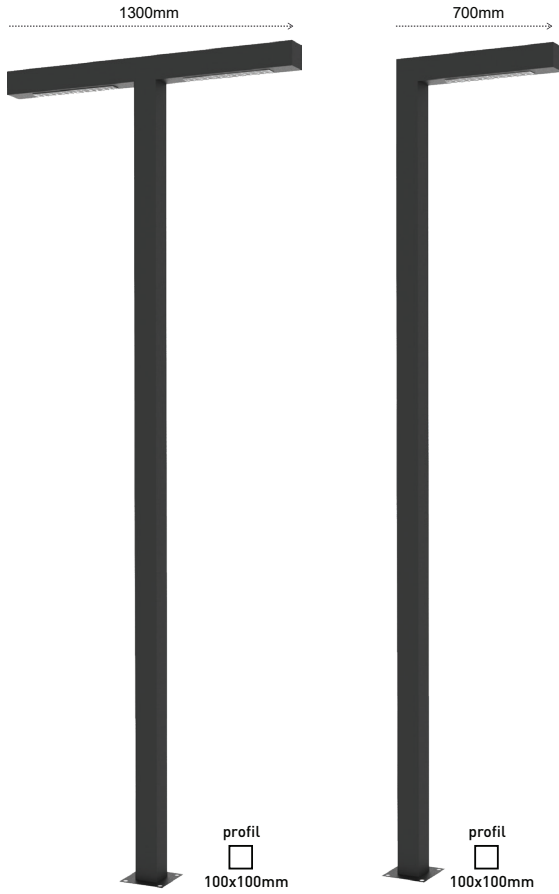

### Olimpos Med

Kod	Güç (W)	Renk Sıcaklığı (K)	Direk Boyutu (mm)	Fiyat
206073	1x30	4000	3000	280,00\$
206072	2x30	4000	3000	383,00\$

Özellikler	Alüminyum	IP65
Opsiyon	Direk Yüksekliği: 3000 - 6000 mm	

\* Özel ölçüler için satış ekibimiz ile iletişime geçiniz.

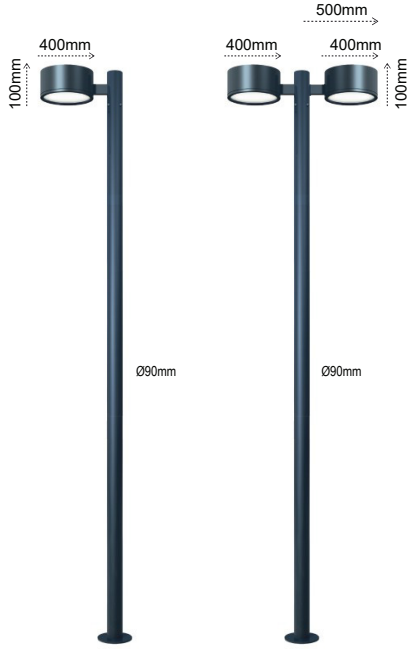

### Amos

Kod	Güç (W)	Renk Sıcaklığı (K)	Direk Boyutu (mm)	Fiyat
212315	40	4000	4000	350,00\$
212316	2x40	4000	4000	505,00\$

- Özellikler**
- Alüminyum
  - Temperli Cam
  - Galvaniz Direk
  - IP54
- Opsiyonlar**
- DALI
  - 1-10V
  - Marin Boya
  - Direk Yüksekliği: 3000 - 6000 mm

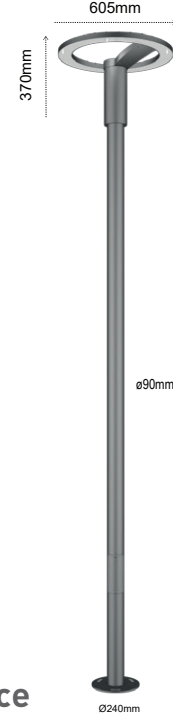

### Troya Elegance

Kod	Güç (W)	Renk Sıcaklığı (K)	Direk Boyutu (mm)	Fiyat
209935	30	4000	4500	490,00\$
209938	40	4000	4500	490,00\$
209941	50	4000	4500	490,00\$
209944	60	4000	4500	490,00\$

- Özellikler**
- Alüminyum
  - Galvaniz Direk
  - IP65
- Opsiyon**
- Direk Yüksekliği: 3000 - 6000 mm

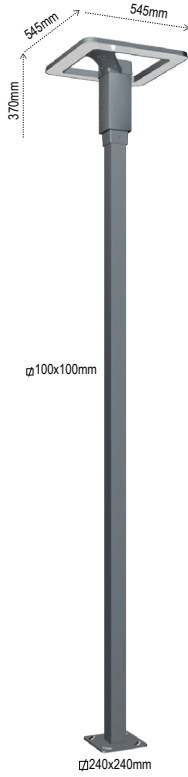

### Gordion

Kod	Güç (W)	Renk Sıcaklığı (K)	Direk Boyutu (mm)	Fiyat
209946	30	4000	4000	685,00\$
209947	40	4000	4000	685,00\$
209948	50	4000	4000	685,00\$
209949	60	4000	4000	685,00\$

- Özellikler**
- Alüminyum
  - Galvaniz Direk
  - IP65
- Opsiyon**
- Direk Yüksekliği: 3000 - 6000 mm

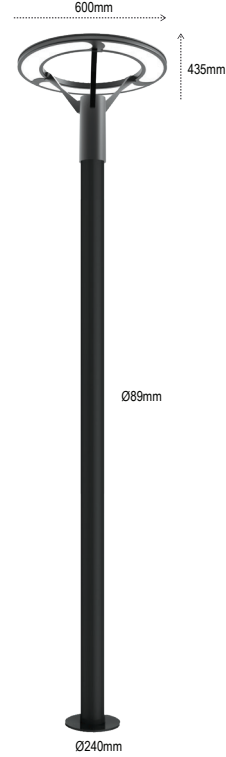

### Troya G2

Kod	Güç (W)	Renk Sıcaklığı (K)	Direk Boyutu (mm)	Fiyat
206776	25	4000	4500	740,00\$
206780	50	4000	4500	740,00\$
206783	75	4000	4500	740,00\$

- Özellikler**
- Alüminyum
  - Galvaniz Direk
  - IP65
- Opsiyon**
- Direk Yüksekliği: 3000 - 6000 mm



**Larissa**

Kod	Güç (W)	Renk Sıcaklığı (K)	Direk Boyutu (mm)	Fiyat
212305	20	3000	2000	<b>275,00\$</b>
212306	30	3000	2500	<b>320,00\$</b>

Özellikler  Alüminyum  Temperli Cam  IP65

Opsiyonlar  DALI  Marin Boya

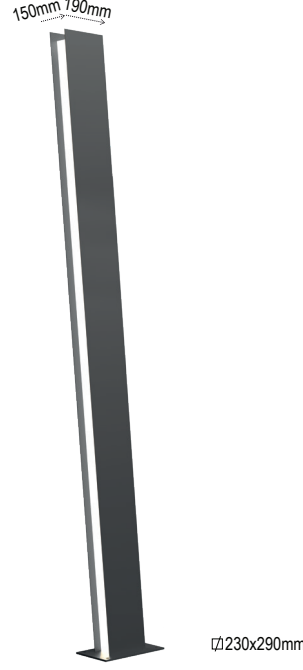
**Cauna**

Kod	Güç (W)	Renk Sıcaklığı (K)	Direk Boyutu (mm)	Fiyat
212299	40	4000	2000	<b>630,00\$</b>
212298	50	4000	2500	<b>805,00\$</b>

Özellikler  Alüminyum  IP54

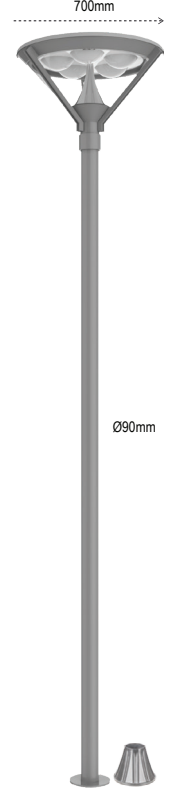
**Limra**

Kod	Güç (W)	Renk Sıcaklığı (K)	Direk Boyutu (mm)	Fiyat
108606	38 (3'lü)	4000	4500	<b>631,00\$</b>
108605	80 (5'li)	4000	4500	<b>820,00\$</b>

Özellikler  IP54

**Luzon**

Kod	Güç (W)	Renk Sıcaklığı (K)	Direk Boyutu (mm)	Fiyat
109736	40	4000	2500	<b>725,00\$</b>

Özellikler  Alüminyum  IP54

**Milas**

Kod	Güç (W)	Renk Sıcaklığı (K)	Direk Boyutu (mm)	Fiyat
108500	100	4000	2500	<b>990,00\$</b>

Özellikler  Alüminyum  IP65

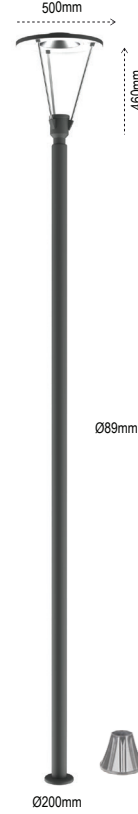
**Petra**

Kod	Güç (W)	Renk Sıcaklığı (K)	Direk Boyutu (mm)	Fiyat
107882	50	4000	4500	<b>730,00\$</b>

Özellikler  IP65

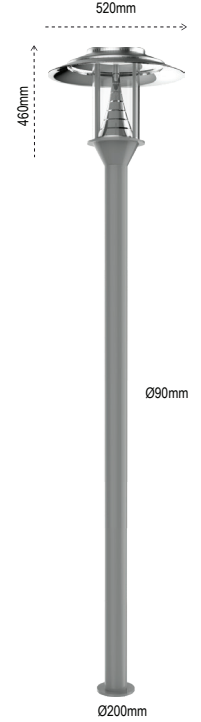
**Evaled**

Kod	Güç (W)	Renk Sıcaklığı (K)	Direk Boyutu (mm)	Fiyat
108610	40	4000	3500	<b>706,00\$</b>

Özellikler  IP54

\* Özel ölçüler için satış ekibimiz ile iletişime geçiniz.



### Lorma

Kod	Güç (W)	Renk Sıcaklığı (K)	Direk Boyutu (mm)	Koli Adedi	Fiyat
212287	1x30	4000	4000	1	980,00\$
212288	2x30	4000	4000	1	1.420,00\$

- Özellikler** Alüminyum Galvaniz Direk IP65
- Opsiyonlar** DALI Marin Boya

### Gamon

Kod	Güç (W)	Renk Sıcaklığı (K)	Direk Boyutu (mm)	Koli Adedi	Fiyat
212289	30	4000	4000	1	725,00\$
212290	50	4000	4000	1	725,00\$

- Özellikler** Alüminyum Temperli Cam Galvaniz Direk IP65
- Opsiyonlar** DALI Marin Boya
- Direk Yüksekliği: 4000 - 6000 mm

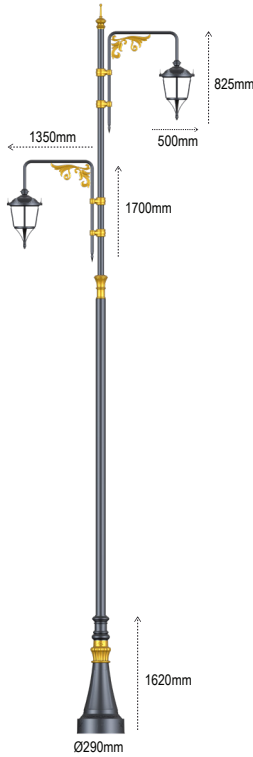

### Kedria

Kod	Güç (W)	Renk Sıcaklığı (K)	Direk Boyutu (mm)	Koli Adedi	Fiyat
212291	50+100	4000	10000	1	2.825,00\$
212292	100+100	4000	10000	1	2.950,00\$

- Özellikler** Alüminyum Temperli Cam Galvaniz Direk IP65
- Opsiyonlar** DALI Marin Boya

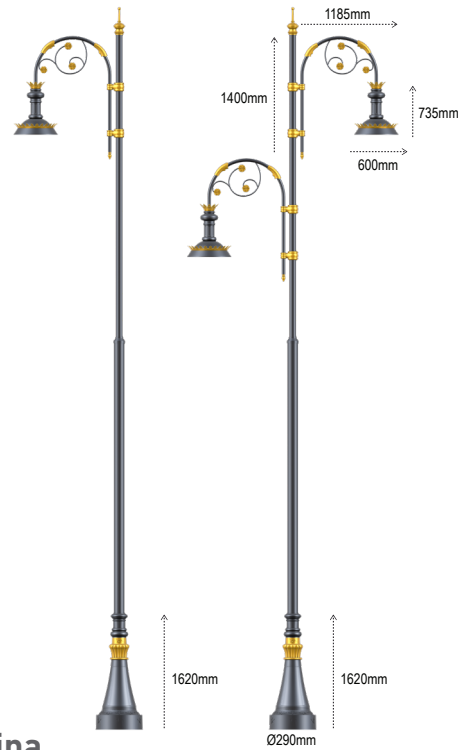

### Lagina

Kod	Güç (W)	Renk Sıcaklığı (K)	Direk Boyutu (mm)	Koli Adedi	Fiyat
212293	100	4000	10000	1	3.300,00\$
212294	50+100	4000	10000	1	3.420,00\$

- Özellikler** Alüminyum Temperli Cam Galvaniz Direk IP65
- Opsiyonlar** DALI Marin Boya

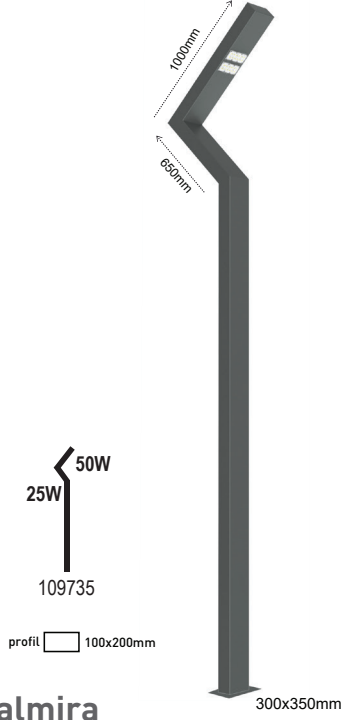

**Palmira**

Kod	Güç (W)	Renk Sıcaklığı (K)	Direk Boyutu (mm)	Fiyat
109735	50+25	4000	4500	<b>1.418,00\$</b>

- Özellikler  Alüminyum  IP65  
Opsiyon  Direk Yüksekliği: 3000 - 6000 mm

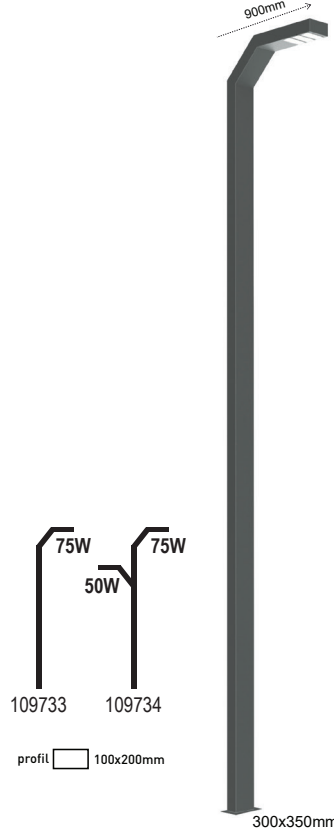

Kod	Güç (W)	Renk Sıcaklığı (K)	Direk Boyutu (mm)	Fiyat
109733	75	4000	6000	<b>1.619,00\$</b>

- Özellikler  Alüminyum  IP65  
Opsiyon  Direk Yüksekliği: 3000 - 6000 mm

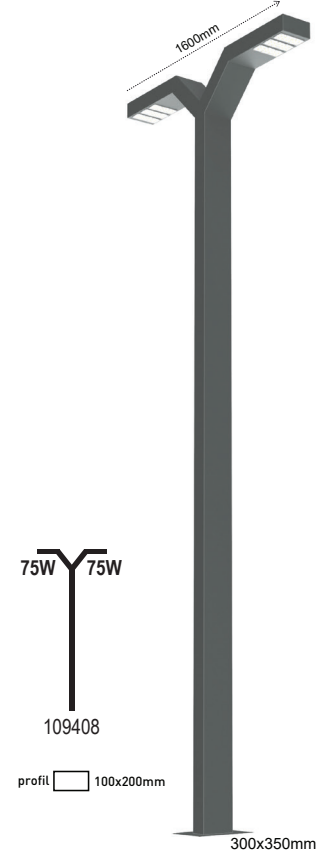

Kod	Güç (W)	Renk Sıcaklığı (K)	Direk Boyutu (mm)	Fiyat
109734	50+75	4000	6000	<b>1.970,00\$</b>
109408	75+75	4000	6000	<b>2.223,00\$</b>

- Özellikler  Alüminyum  IP65  
Opsiyon  Direk Yüksekliği: 3000 - 6000 mm

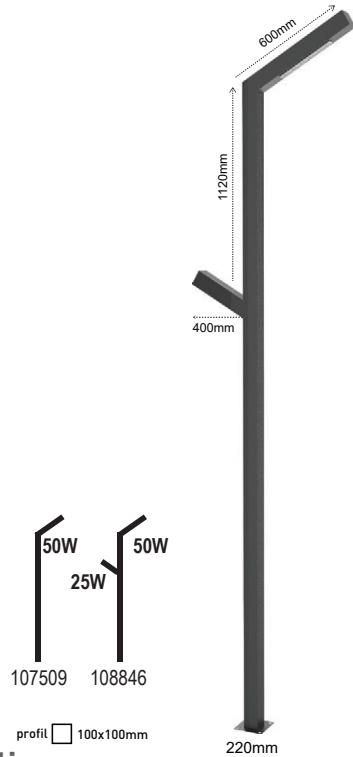
**Olimpos**

Kod	Güç (W)	Renk Sıcaklığı (K)	Direk Boyutu (mm)	Fiyat
107509	50	4000	4500	<b>744,00\$</b>
108846	50+25	4000	4500	<b>891,00\$</b>

- Özellikler  Alüminyum  IP65  
Opsiyon  Direk Yüksekliği: 3000 - 6000 mm

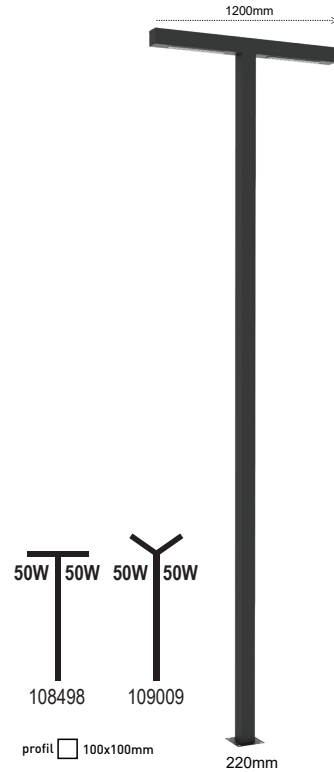

Kod	Güç (W)	Renk Sıcaklığı (K)	Direk Boyutu (mm)	Fiyat
108498	50+50	4000	4500	<b>1.043,00\$</b>

- Özellikler  Alüminyum  IP65  
Opsiyon  Direk Yüksekliği: 3000 - 6000 mm

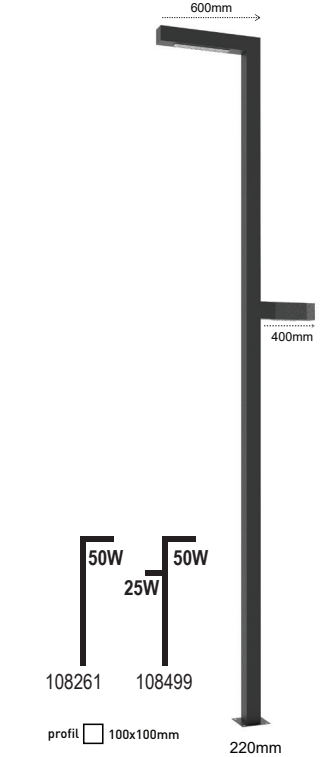

Kod	Güç (W)	Renk Sıcaklığı (K)	Direk Boyutu (mm)	Fiyat
108261	50	4000	4500	<b>744,00\$</b>
108499	50+25	4000	4500	<b>891,00\$</b>

- Özellikler  Alüminyum  IP65  
Opsiyon  Direk Yüksekliği: 3000 - 6000 mm

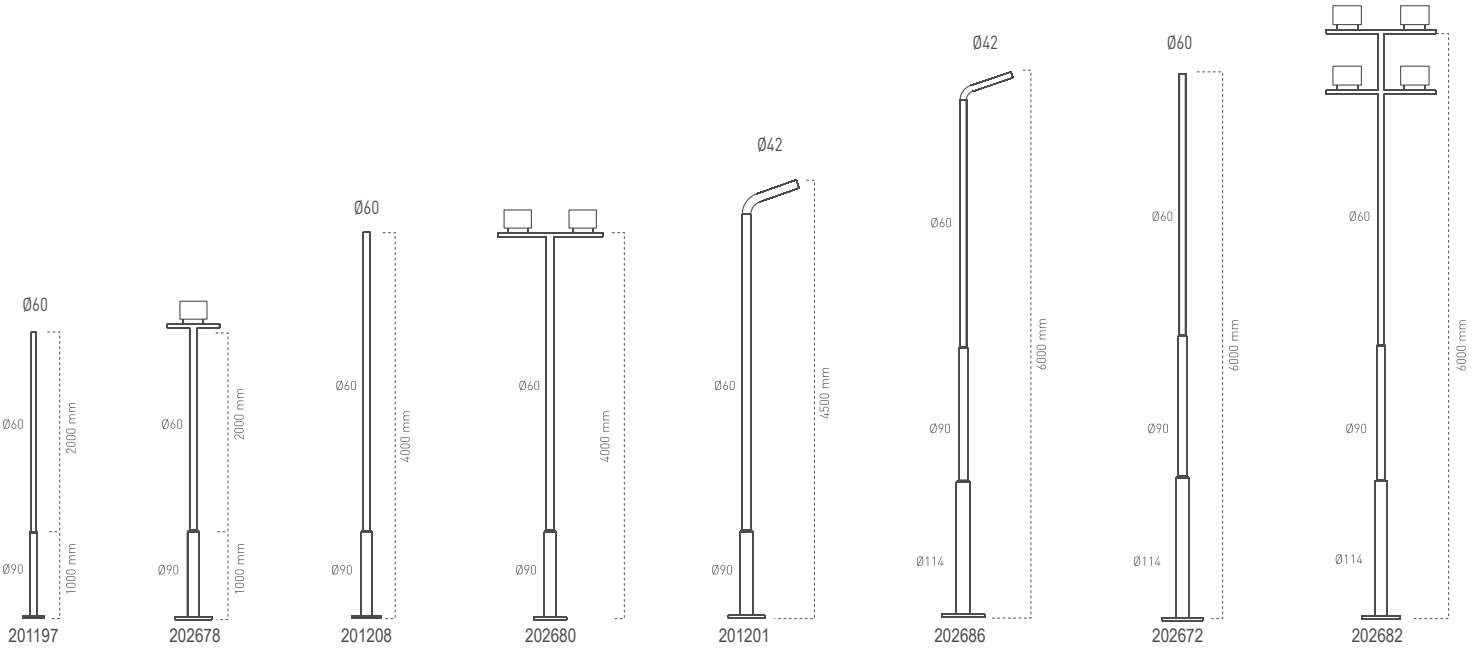

### Yol, Bahçe ve Projektör Direkleri

Kod	Tanım	Koli Adedi	Fiyat
201197	3m Kademeli Boru Direk	1	<b>166,30\$</b>
202678	3m 1 Projektörlük Boru Direk	1	<b>176,50\$</b>
201208	4m Kademeli Boru Direk	1	<b>186,70\$</b>
202680	4m 2 Projektörlük Boru Direk	1	<b>198,00\$</b>

Özellikler Metal IP65

Kod	Tanım	Koli Adedi	Fiyat
201201	4,5m Sokak Lamba Direği	1	<b>210,20\$</b>
202686	6m Sokak Lamba Direği	1	<b>343,90\$</b>
202672	6m Kademeli Boru Direk	1	<b>343,90\$</b>
202682	6m 4 Projektörlük Direk	1	<b>359,20\$</b>
312688	Ankraj 250mm Polyester	1	<b>14,30\$</b>

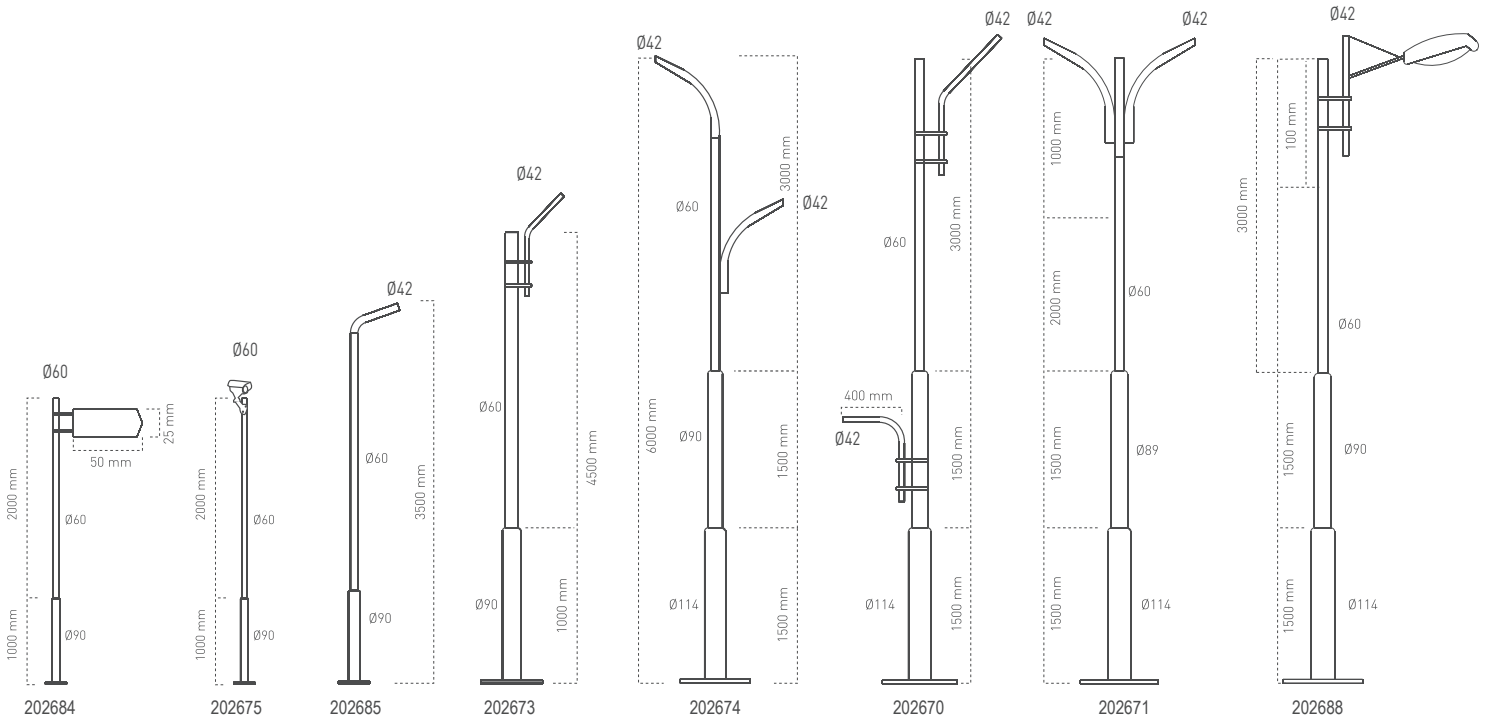

### Yol, Bahçe ve Projektör Direkleri

Kod	Tanım	Koli Adedi	Fiyat
202684	3m Sokak Direği	1	<b>190,80\$</b>
202675	3m Kamera Direği	1	<b>190,80\$</b>
202685	3,5m Sokak Lamba Direği	1	<b>190,80\$</b>
202673	4,5m 1xArmatür Direği	1	<b>211,20\$</b>
312688	Ankraj 250mm Polyester	1	<b>14,30\$</b>

Özellikler Metal IP65

Kod	Tanım	Koli Adedi	Fiyat
202674	6m 2xArmatür Direği	1	<b>359,20\$</b>
202670	6m Çift Armatür Direği	1	<b>382,70\$</b>
202671	6m2xKonsol Direği	1	<b>359,20\$</b>
202668	6m Armatür Direği	1	<b>343,90\$</b>
312688	Ankraj 250mm Polyester	1	<b>14,30\$</b>





### Bali / Maldiv

Kod	Tip	Güç (W)	Renk Sıcaklığı (K)	Boyutlar (mm)	Koli Adedi	Fiyat
108870	Bali	18	4000	750	1	179,00\$
108872	Maldiv	18	4000	750	1	179,00\$

Özellikler  Alüminyum  IP65



### Malta / Santorini

Kod	Tip	Güç (W)	Renk Sıcaklığı (K)	Boyutlar (mm)	Koli Adedi	Fiyat
108871	Malta	2x18	4000	750	1	285,00\$
108873	Santorini	2x18	4000	750	1	285,00\$

Özellikler  Alüminyum  IP65



### Olimpos Med

Kod	Güç (W)	Renk Sıcaklığı (K)	Boyutlar (mm)	Koli Adedi	Fiyat
206074	14	4000	600	1	145,00\$
206075	18	4000	1000	1	149,00\$

Özellikler  Alüminyum  IP65



### Pega

Kod	Güç (W)	Renk Sıcaklığı (K)	Boyutlar (mm)h	Koli Adedi	Fiyat
108878	18	4000	750	1	188,00\$

Özellikler  Alüminyum  IP65



### Alberi

Kod	Güç (W)	Renk Sıcaklığı (K)	Boyutlar (mm)	Koli Adedi	Fiyat
208554	6	3000	500	1	65,30 \$
208555	6	3000	700	1	70,40 \$

Özellikler  Alüminyum  IP54



### Belise

Kod	Güç (W)	Renk Sıcaklığı (K)	Boyutlar (mm)	Koli Adedi	Fiyat
208530	6	3000	500	1	65,30 \$
208531	6	3000	750	1	70,40 \$

Özellikler  Alüminyum  IP54





### Ayers

Kod	Güç (W)	Renk Sıcaklığı (K)	Boyutlar (mm)	Koli Adedi	Fiyat
208542	6	3000	500	1	80,60 \$
208543	6	3000	800	1	88,70 \$

Özellikler  Alüminyum  IP54





-  **IP66, Toz ve Su Almaz**
-  **Kamaşma Önleyici Optik Dizayn**
-  **Alüminyum Gövde**

### Opsiyonlar,

- \* RAL9005, RAL7043
- \* DALI
- \* Marin Boya



### Luzon IP66

Kod	Güç (W)	Renk Sıcaklığı (K)	Boyutlar (mm)	Koli Adedi	Fiyat
115479	14	4000	655	1	140,00\$

Özellikler  Alüminyum  IP66



### Luzon / Luzon 2

Kod	Güç (W)	Renk Sıcaklığı (K)	Boyutlar (mm)	Koli Adedi	Fiyat
109027	20	4000	750	1	234,00\$
110753	14	4000	655	1	120,00\$

Özellikler  Alüminyum  IP54

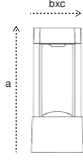

**Alberi**

Kod	Güç (W)	Renk Sıcaklığı (K)	Boyutlar (mm)axbxc	Koli Adedi	Fiyat
208553	6	3000	250x100x100	1	<b>56,10\$</b>

Özellikler Alüminyum IP54

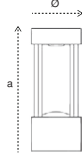

**Belise**

Kod	Güç (W)	Renk Sıcaklığı (K)	Boyutlar (mm)axØ	Koli Adedi	Fiyat
208529	6	3000	250x100	1	<b>56,10\$</b>

Özellikler Alüminyum IP54

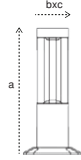

**Ayers**

Kod	Güç (W)	Renk Sıcaklığı (K)	Boyutlar (mm)axbxc	Koli Adedi	Fiyat
208541	6	3000	250x70x70	1	<b>71,40\$</b>

Özellikler Alüminyum IP54

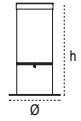

**Tino**

Kod	Güç (W)	Renk Sıcaklığı (K)	Boyutlar (mm)axh	Koli Adedi	Fiyat
110709	E27	-	170x310	1	<b>70,00\$</b>

Özellikler Alüminyum IP54

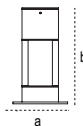

**Alinda**

Kod	Güç (W)	Renk Sıcaklığı (K)	Boyutlar (mm)axb	Koli Adedi	Fiyat
109401	15	400	200x310	8	<b>131,00\$</b>

Özellikler Alüminyum IP65

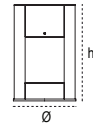

**Pega**

Kod	Güç (W)	Renk Sıcaklığı (K)	Boyutlar (mm)axh	Koli Adedi	Fiyat
109403	15	400	200x310	2	<b>131,00\$</b>

Özellikler Alüminyum IP65



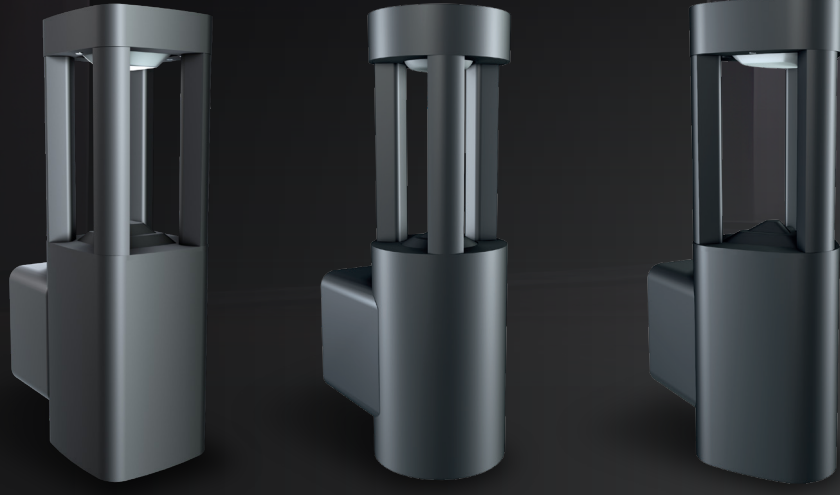

209856

209857

208562



209858

209859

208538



209860

209865

208550

### Alberi

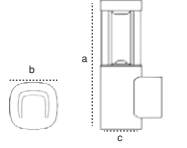

Kod	Tip	Güç (W)	Renk Sıcaklığı (K)	Boyutlar (mm)axbxc	Koli Adedi	Fiyat
208562	-	6	3000	220x70x70	1	70,40\$
209856	Down	6	3000	160x70	1	53,30\$
209857	Up / Down	12	3000	240x70	1	77,55\$

Özellikler  Alüminyum  IP54

### Belise

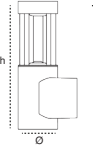

Kod	Tip	Güç (W)	Renk Sıcaklığı (K)	Boyutlar (mm)øxh	Koli Adedi	Fiyat
208538	-	6	3000	70x220	1	70,40\$
209858	Down	6	3000	70x160	1	53,30\$
209859	Up / Down	12	3000	70x240	1	77,55\$

Özellikler  Alüminyum  IP54

### Ayers

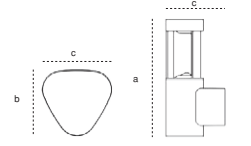

Kod	Tip	Güç (W)	Renk Sıcaklığı (K)	Boyutlar (mm)axbxc	Koli Adedi	Fiyat
208550	-	6	3000	220x70x70	1	88,70\$
209860	Down	6	3000	160x70	1	53,30\$
209865	Up / Down	12	3000	240x70	1	77,55\$

Özellikler  Alüminyum  IP54

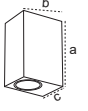

### Carla

Kod	Güç (W)	Renk Sıcaklığı (K)	Boyutlar (mm)axbxc	Koli Adedi	Fiyat
207106	2xGu10	-	150x93x70	1	30,00\$

Özellikler Alüminyum IP44

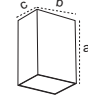
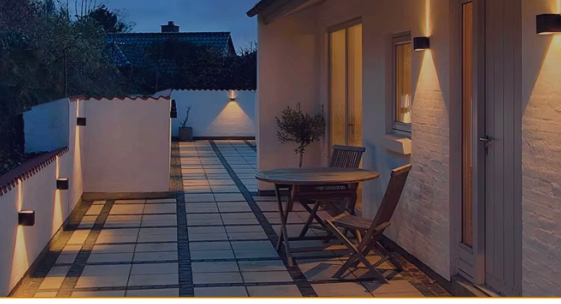

### Vasco

Kod	Güç (W)	Renk Sıcaklığı (K)	Boyutlar (mm)axbxc	Koli Adedi	Fiyat
207108	2x4	3000	162x90x58	1	35,00\$

Özellikler Alüminyum IP44

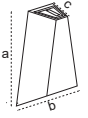
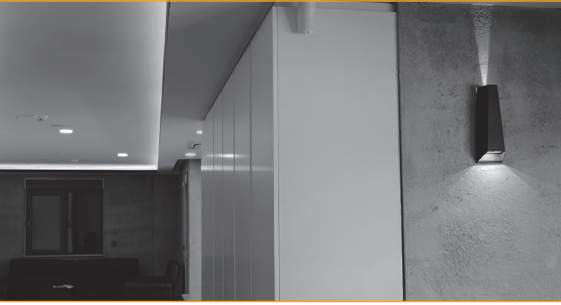

### Santos

Kod	Güç (W)	Renk Sıcaklığı (K)	Boyutlar (mm)axbxc	Koli Adedi	Fiyat
207110	2x3	3000	176x111x62	1	35,00\$

Özellikler Alüminyum IP44

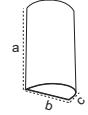

### Dura

Kod	Güç (W)	Renk Sıcaklığı (K)	Boyutlar (mm)axbxc	Koli Adedi	Fiyat
208145	2x4	3000	160x90x58	1	35,00\$

Özellikler Alüminyum IP44

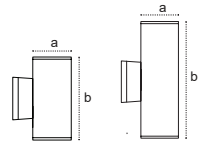
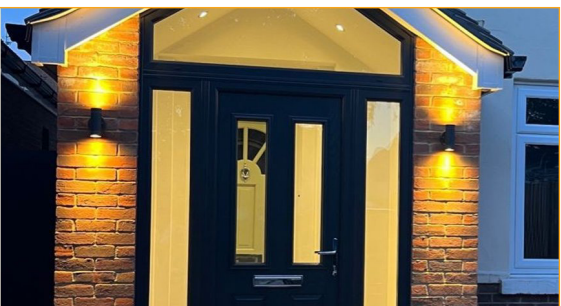

### Işıl1 / Işıl2

Kod	Duy	Renk Sıcaklığı (K)	Boyutlar (mm)axb	Koli Adedi	Fiyat
110742	E27	-	120x180	8	50,00\$
110743	2xE27	-	120x300	6	63,00\$

Özellikler Alüminyum IP54

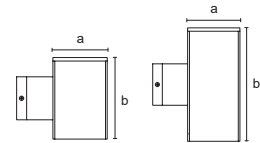

### Tibat1 / Tibat2

Kod	Duy	Renk Sıcaklığı (K)	Boyutlar (mm)axb	Koli Adedi	Fiyat
110744	E27	-	120x180	8	52,00\$
110745	2xE27	-	120x305	6	65,00\$

Özellikler Alüminyum IP54





## Mova (Sensörlü)

Kod	Güç (W)	Renk Sıcaklığı (K)	Boyutlar (mm)øxh	Koli Adedi	Fiyat
115746	10	4000	255x185	20	29,10\$
109228	10	6500	255x185	20	29,10\$
110324	10	4000	255x185	20	29,10\$

Özellikler  PC  IP54

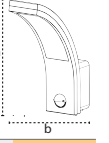

## Mova

Kod	Güç (W)	Renk Sıcaklığı (K)	Boyutlar (mm)øxh	Koli Adedi	Fiyat
111603	10	4000	255x185	20	21,70\$

Özellikler  PC  IP54

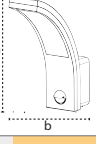

## Ferra (Sensörlü)

Kod	Güç (W)	Renk Sıcaklığı (K)	Boyutlar (mm)øxh	Koli Adedi	Fiyat
113599	20	4000	244x100	10	47,95\$

Özellikler  PC  IP65

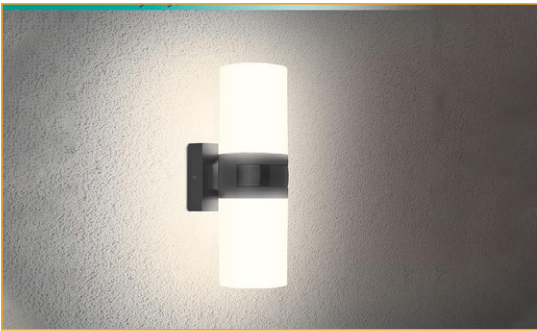
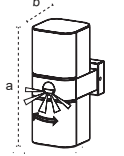

## Tilva (Sensörlü)

Kod	Güç (W)	Renk Sıcaklığı (K)	Boyutlar (mm)øxh	Koli Adedi	Fiyat
113596	20	4000	250x80	20	47,95\$

Özellikler  PC  IP65

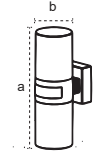

## Grada (Sensörlü)

Kod	Güç (W)	Renk Sıcaklığı (K)	Boyutlar (mm)øxh	Koli Adedi	Fiyat
113600	2x10	4000	156,3x75	8	53,00\$

Özellikler  Alüminyum  IP65

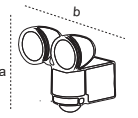



**IP65**

**Güçlü Işık**

**Etkili Aydınlatma**

**Santa Çimen / Bahçe Armatürü**

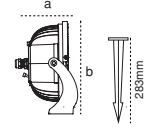
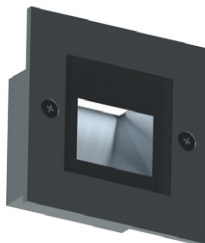

**Santa**

Çimen / Bahçe Armatürü

Kod	Güç (W)	Renk Sıcaklığı (K)	Boyutlar (mm)axb	Koli Adedi	Fiyat
216103	22	4000	101x185	1	140,00\$
216104	22	6500	101x185	1	140,00\$
213826	32	4000	101x185	1	148,00\$
213827	32	6500	101x185	1	148,00\$
213829	47	4000	101x185	1	164,30\$
213830	47	6500	101x185	1	164,30\$
213832	55	4000	101x185	1	180,60\$
213833	55	6500	101x185	1	180,60\$

Özellikler Alüminyum IP65

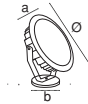

**Grased**

Çimen / Bahçe Armatürü

Kod	Güç (W)	Renk Sıcaklığı (K)	Boyutlar (mm)axb	Koli Adedi	Fiyat
209920	3	4000	110x75x75	1	33,00\$
209921	3	6500	110x75x75	1	33,00\$
209923	6	4000	150x122x1100	1	57,00\$
209924	6	6500	150x122x1100	1	57,00\$
209926	9	4000	150x122x1100	1	65,00\$
209927	9	6500	150x122x1100	1	65,00\$

Özellikler Alüminyum IP65

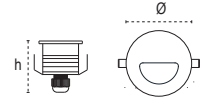

**Oscaled**

Duvar Armatürü

Kod	Güç (W)	Renk Sıcaklığı (K)	Boyutlar (mm)axbxh	Koli Adedi	Fiyat
206013	3	4000	59x60	1	104,60\$

Özellikler Alüminyum IP65

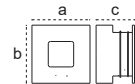

**Escaled**

Duvar Armatürü

Kod	Güç (W)	Renk Sıcaklığı (K)	Boyutlar (mm)axbxc	Koli Adedi	Fiyat
205989	3	4000	85x85x45	1	110,70\$

Özellikler Alüminyum IP65





### Yer Gömme Ø80



Kod	Güç (W)	Renk Sıcaklığı (K)	Boyutlar (mm)axbxc	Koli Adedi	Fiyat
205998	3	4000	110x90x80	1	152,00\$

Özellikler  Alüminyum  IP67



### Yer Gömme Ø100



Kod	Güç (W)	Renk Sıcaklığı (K)	Boyutlar (mm)axbxc	Koli Adedi	Fiyat
206001	6	4000	115x110x105	1	190,80\$

Özellikler  Alüminyum  IP67



### Yer Gömme Ø150



Kod	Güç (W)	Renk Sıcaklığı (K)	Boyutlar (mm)axbxc	Koli Adedi	Fiyat
206004	6	4000	150x140x100	1	281,10\$
206007	18	4000	150x140x100	1	281,10\$
206010	27	4000	150x140x100	1	281,10\$

Özellikler  Alüminyum  IP67

**ATEX Belgeleri**

ATEX Belgeli Pelsan Exproof armatürler, tehlikeli gaz ve toz maddelerinin bulunduğu, patlama riski olan ortamlarda güvenle kullanılabilir.

**Zone2, Zone22**



ATEX  
Largo G2 Ex-Proof

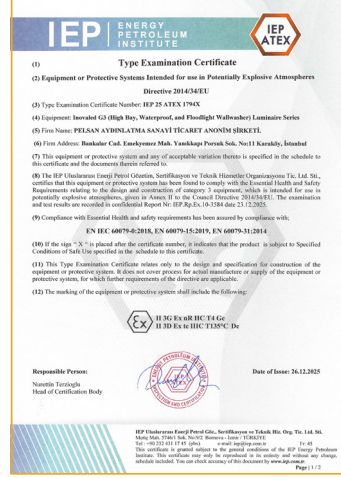

ATEX  
Inovald G3 Ex-Proof

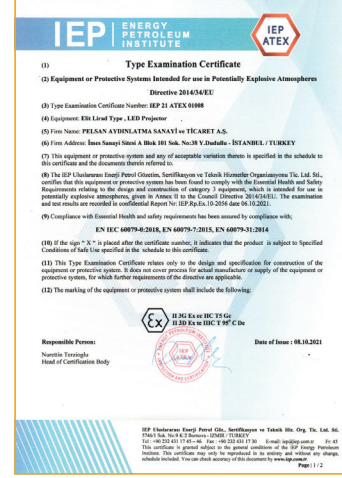

ATEX  
Elit Lirad Ex-Proof

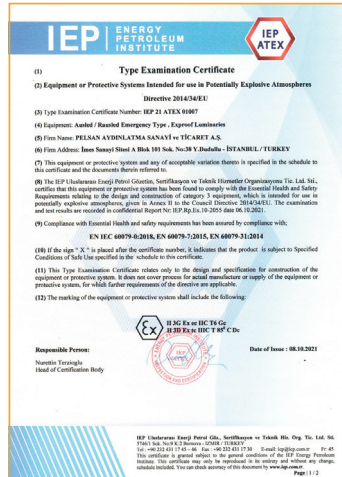

ATEX  
Ausled-Raused  
Ex-Proof



ATEX  
Sia/Nairo/Piriliz  
Ex-Proof

**Zone1, Zone21**



ATEX  
Atarex Yüksek Tavan  
Ex-Proof



ATEX  
Atarex Projektör  
Ex-Proof



ATEX  
Extax Ex-Proof



ATEX  
Sia G2, Nairo G2, Piriliz G2  
Ex-Proof





**EAC Belgeleri**

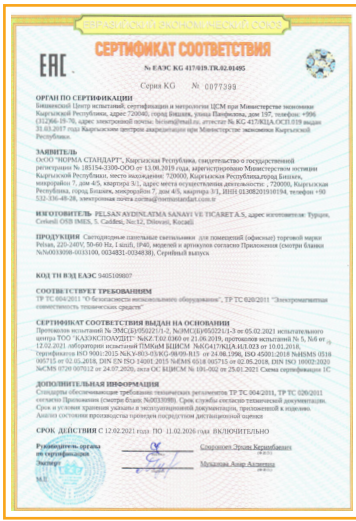

Ofis Armatürler

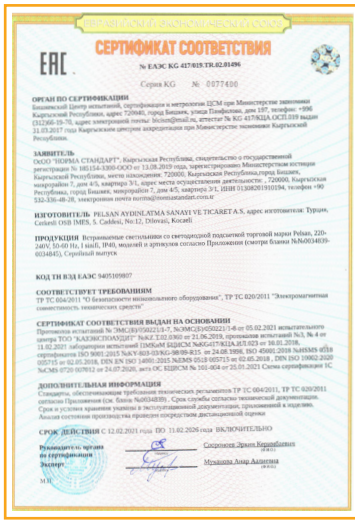

Downlight

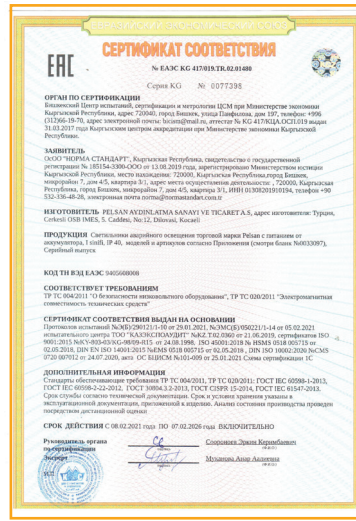

Acil Aydınlatma Armatürleri

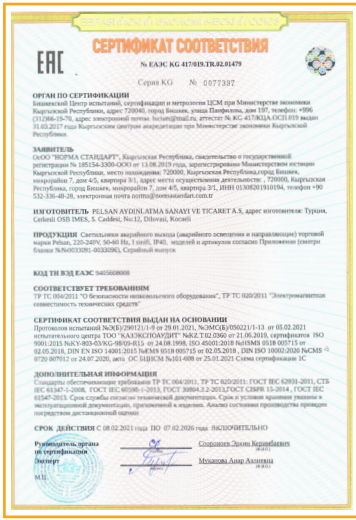

Acil Aydınlatma ve Yönlendirme Armatürleri

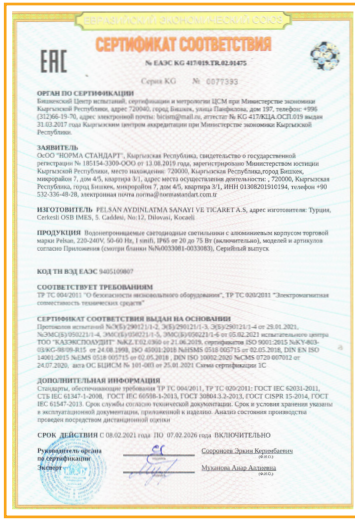

Etanj Armatürler

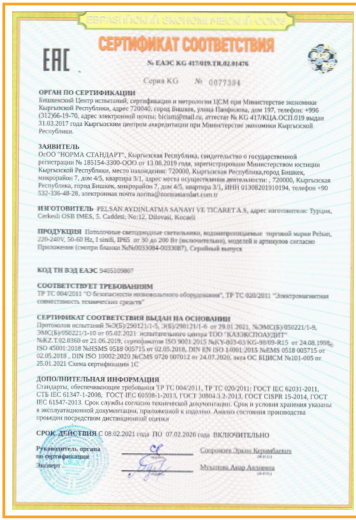

Yüksek Tavan Armatürleri

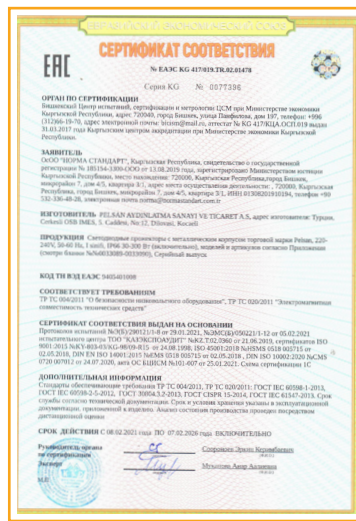

Projektörler

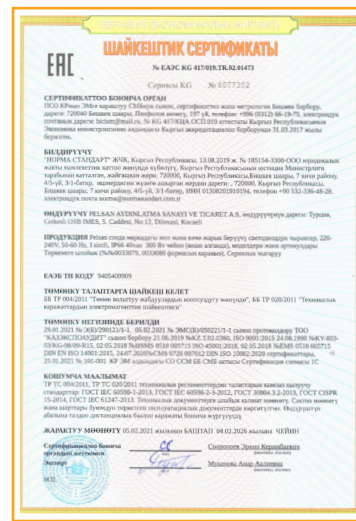

Yol ve Caddeler Armatürleri





# Zone1, Zone21 ATEX Belgeli Ex-Proof Armatürler

● Gaz Patlama Koruması: Zone 1 ● Toz Patlama Koruması: Zone 21



ZONE 1  
ZONE 21

II 2G Ex db IIB T6 Gb  
II 2D Ex tb IIIC (T85°C) Db

Ex-Proof Etanj ve Yüksek Tavan Armatürü

ZONE 1  
ZONE 21

II 2G Ex db IIB T6 Gb  
II 2D Ex tb IIIC (T85°C) Db

Ex-Proof Acil Aydınlatma ve Yönlendirme Armatürü

Ex-Proof Etanj - Yüksek Tavan,  
Ex-Proof Aydınlatma ve Yönlendirme Armatürü  
Sayfa 40



Güncel ürün bilgisi ve belgeleri için [www.pelsan.com.tr](http://www.pelsan.com.tr)' yi ziyaret ediniz.

[www.pelsan.com.tr](http://www.pelsan.com.tr)  
[info@pelsan.com.tr](mailto:info@pelsan.com.tr) | [export@pelsan.com.tr](mailto:export@pelsan.com.tr)

**Pelsan**

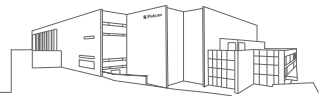

**GENEL MERKEZ**  
İmes Sanayi Sitesi  
A Blok 101 Sk. No:38  
Y.Dudullu / İstanbul  
T: (0850) 460 75 76  
F: (0212) 364 60 15

**FABRİKA**  
Çerkeşli O.S.B. İmes  
5.Cadde No:12  
Dilovası / Kocaeli  
T: (0850) 460 75 76  
F: (0212) 364 60 15

**KARAKÖY MERKEZ**  
Emekyemez Mah.  
Yanıkkapı Porsuk Sk.  
No:11 Karaköy / İstanbul  
T: (0850) 460 75 76  
F: (0212) 364 60 15

**PERPA BÖLGE OFİSİ**  
Perpa Ticaret Merkezi  
A Blok Kat:9 No:1178  
Okmeydanı / İstanbul  
T: (0850) 460 75 76  
F: (0212) 364 60 15

Fiyatlara K.D.V. dahil değildir. Pelsan Aydınlatma gerekli koşullarda fiyat ve ürün değiştirme hakkını saklı tutar.